

Corometrics Toco - External Cable

PS-320

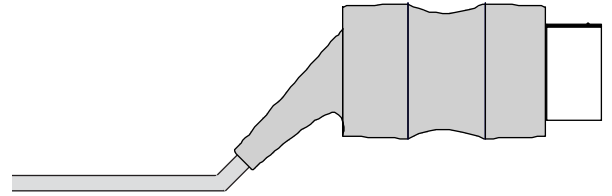

mini-DIN
Connector

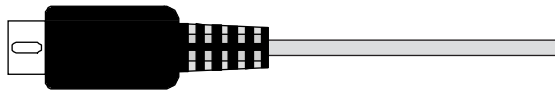
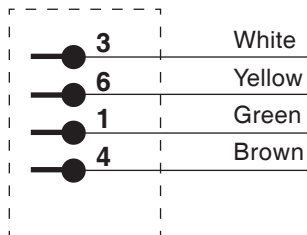

Corometrics
Connector

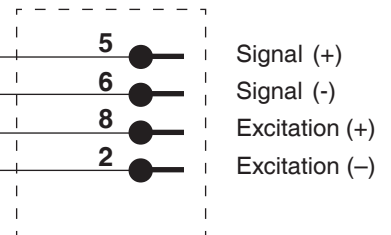

mini-DIN Connector

- 1. Green
- 3. White
- 4. Brown
- 6. Yellow

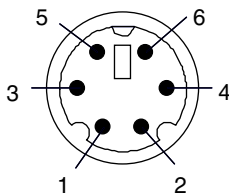

Front side

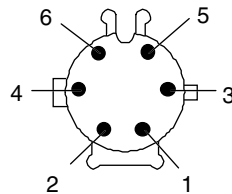

Solder side

Corometrics Connector

- 2. Brown
- 5. White
- 6. Yellow
- 8. Green

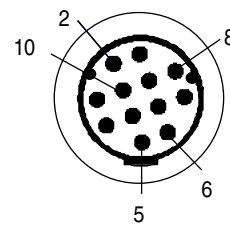

Front side

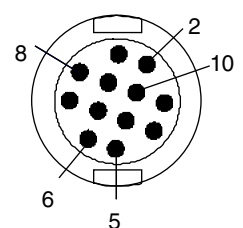

Solder side

Order no.: 17481

Component list:

mini-DIN Connector: male, 6 pole, black
 Corometrics Conn.: KT-017B
 Cable: 6 x 0.14 mm², 1.75 m, grey

Metron AS
 Travbaneveien 1
 N-7044 Trondheim, NORWAY
 Phone: +47 73 82 85 00
 Fax: +47 73 91 70 09
 E-mail: support@metron.no

METRON AS Norway	DESCRIPTION Corometrics Toco - External Cable	
	DRAW CAT. Schematic diagram	
	DRAW NO. .	
PRODUCT PS-320	DATE 03.06.2001	PAGE 1 av 1

Corometrics - Ultrasound Cable

PS-320

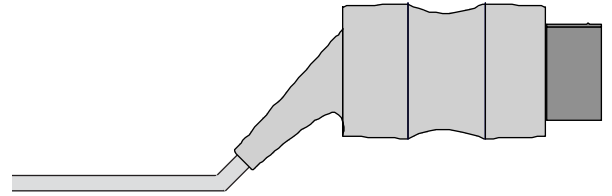
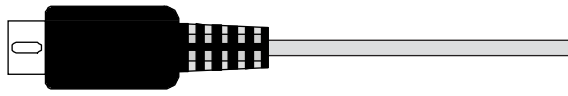

mini-DIN Connector

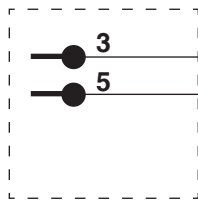

Green
Yellow

Corometrics Connector

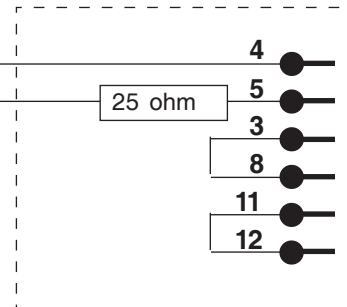

Common
US1

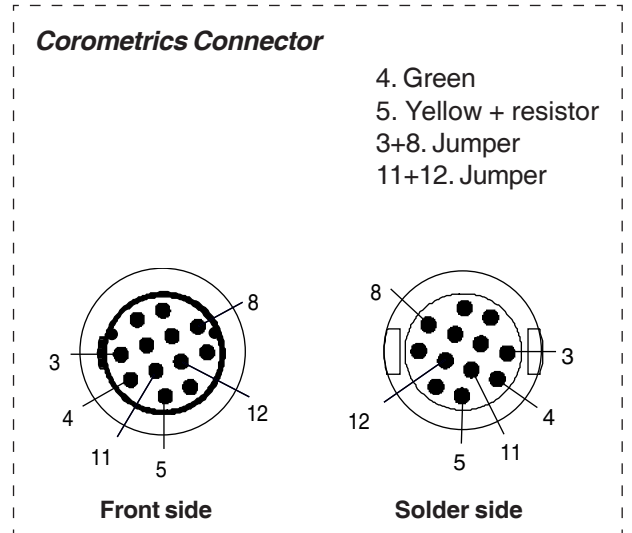
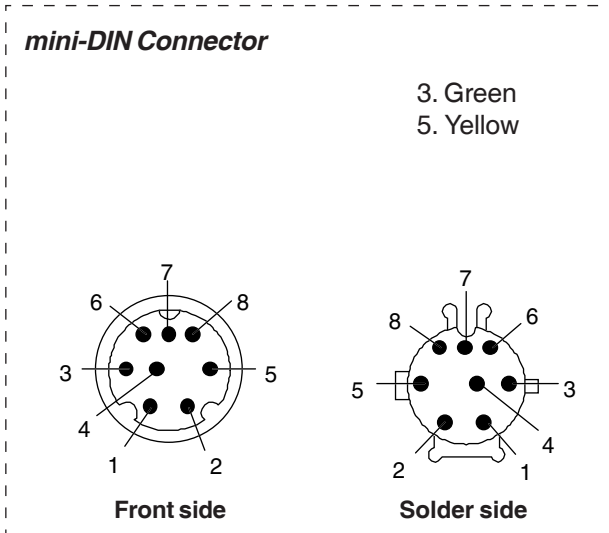

Order no.: 17483

Component list:

- mini-DIN Connector: male, 8 pole, black
- Corometrics Conn.: KT-021B
- Cable: 6 x 0.14 mm², 1.75 m, grey
- Resistor: 25 ohm 1% 1 ea

Metron AS
 Travbaneveien 1
 N-7044 Trondheim, NORWAY
 Phone: +47 73 82 85 00
 Fax: +47 73 91 70 09
 E-mail: support@metron.no

METRON AS Norway	DESCRIPTION Corometric - Ultrasound Cable	
	DRAW CAT. Schematic diagram	
	DRAW NO. .	
PRODUCT PS-320	DATE 03.06.2001	PAGE 1 av 1

Agilent 50 Series Toco - External Cable

PS-320



mini-DIN Connector

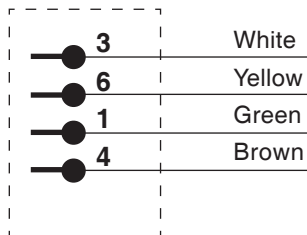

Agilent Connector

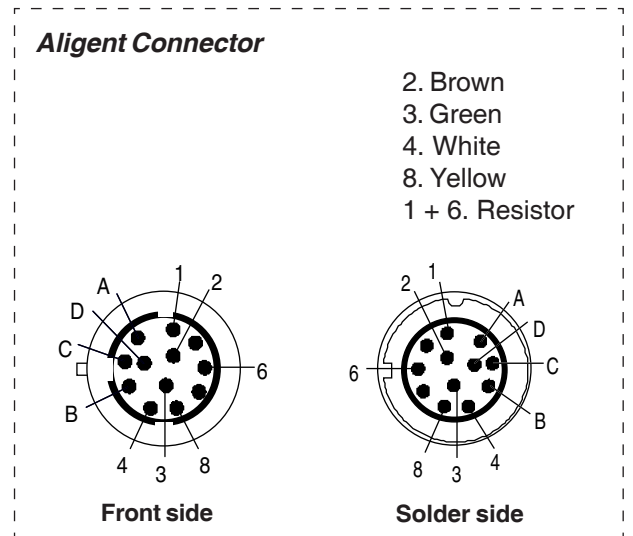
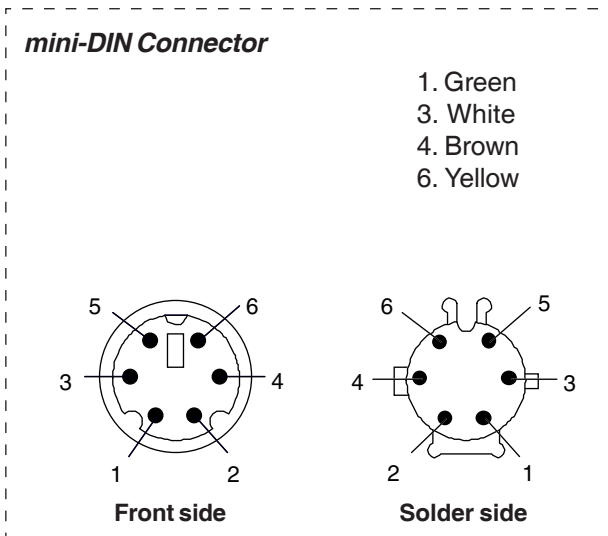
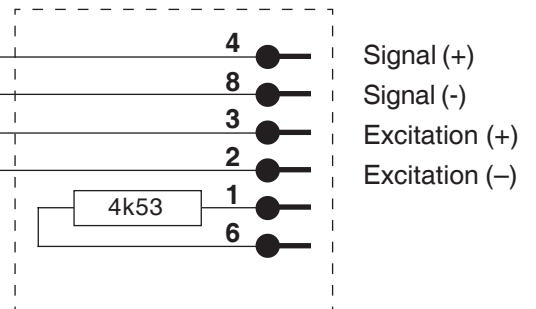

Order no.: 17484

Component list:

- mini-DIN Connector: male, 6 pole, black
- Agilent Connector: PN 1251-6887 (brown)
- Cable sleeve: 120600 Skindicht - SNR 7/5
- Cable: 6 x 0.14 mm², 1.75 m, grey
- Resistor: 4k53 1% 1 ea

Metron AS
 Travbaneveien 1
 N-7044 Trondheim, NORWAY
 Phone: +47 73 82 85 00
 Fax: +47 73 91 70 09
 E-mail: support@metron.no

METRON AS Norway	DESCRIPTION Agilent 50 Series Toco - External Cable	
	DRAW CAT. Schematic diagram	
	DRAW NO.	
PRODUCT PS-320	DATE 03.06.2001	PAGE 1 av 1

Corometrics Toco - IUP Cable

PS-320



mini-DIN Connector



Corometrics Connector

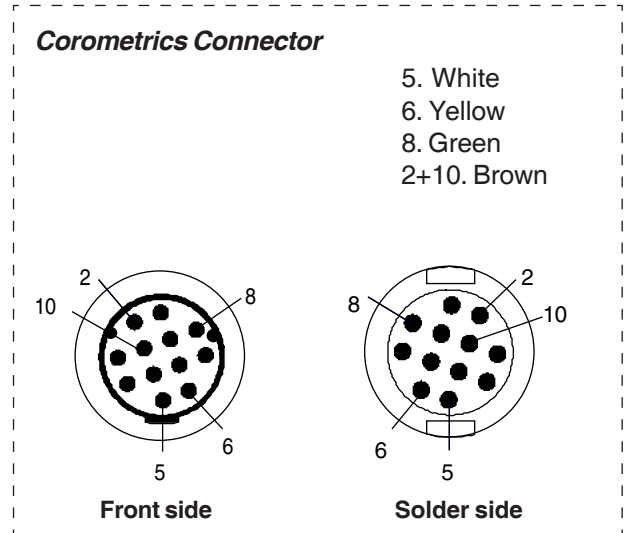
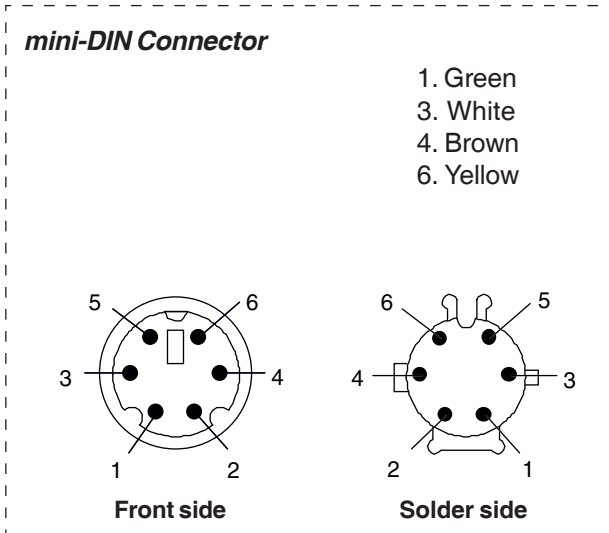
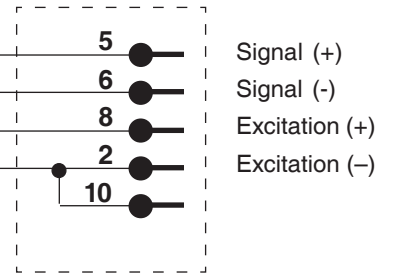

Order no.: 17486

Component list:

mini-DIN Connector: male, 6 pole, black
 Corometrics Conn.: KT-017B
 Cable: 6 x 0.14 mm², 1.75 m, grey

Metron AS
 Travbaneveien 1
 N-7044 Trondheim, NORWAY
 Phone: +47 73 82 85 00
 Fax: +47 73 91 70 09
 E-mail: support@metron.no

METRON AS Norway	DESCRIPTION Corometrics Toco - IUP Cable	
	DRAW CAT. Schematics diagram	
	DRAW NO. .	
PRODUCT PS-320	DATE 03.06.2001	PAGE 1 av 1

Rev	ECN No.
2	10203

This drawing is the property of Fluke Biomedical, neither the drawing, nor reproductions of it, nor information derived from it is to be given to others. No use is to be made of it which is, or may be injurious to the Fluke Corporation.

NOTES:

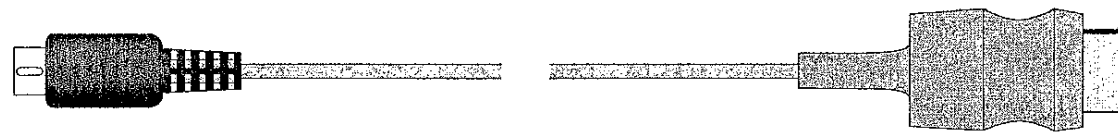

mini-DIN Connector

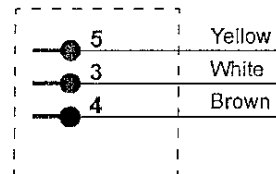

Oxford Connector

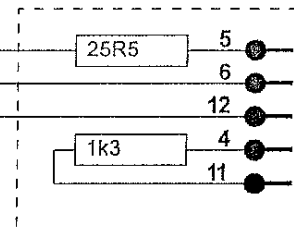

mini-DIN Connector

- 3. White
- 4. Brown
- 5. Yellow

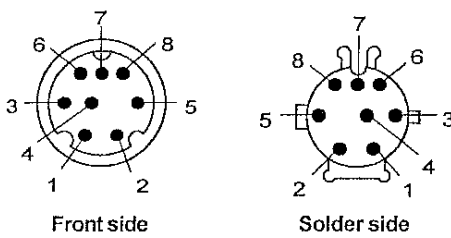

Oxford Connector

- 5. Resistor + Yellow
- 6. White
- 12. Brown
- 4. Resistor
- 11. Resistor

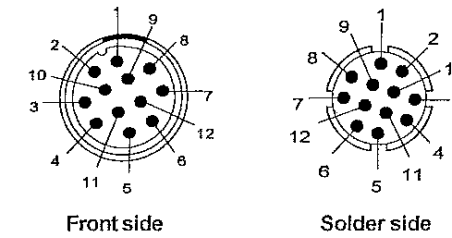

PROPRIETARY NOTICE

THIS DOCUMENT CONTAINS INFORMATION PROPRIETARY TO THE FLUKE CORPORATION, AND SHALL NOT BE USED FOR ENGINEERING DESIGN, PROCUREMENT, OR MANUFACTURE IN WHOLE OR IN PART WITHOUT EXPRESS WRITTEN CONSENT OF THE FLUKE CORPORATION.

Unless otherwise specified, dimensions are in inches, tolerances are:
 Decimals: .XX±.015 .XXX±.005
 Angles: ±1° Fractions: ±1/32 Finish: 63 ✓
 Remove all burrs & break sharp edges .005 to .015



FLUKE CORPORATION
 P.O. BOX 9090
 EVERETT, WASHINGTON 98206-9090

Drawn by	Date
<i>M. Hult</i>	1/22/08
Engineer	
<i>[Signature]</i>	1/22/08
Approved	
<i>N/A</i>	-
QA	
<i>[Signature]</i>	1/25/08

Title	
17490, OXFORD ULTRASND SIMU CABLE 1.5MHZ (YEL) PS-320	
Size	Cage No
B	1JZH3
Dwg No	Rev
2462555	2
Scale	Do Not Scale
1/1	Sheet 1 Of 1

Rev	ECN No.
2	10203

This drawing is the property of Fluke Biomedical, neither the drawing, nor reproductions of it, nor information derived from it is to be given to others. No use is to be made of it which is, or may be injurious to the Fluke Corporation.

NOTES:

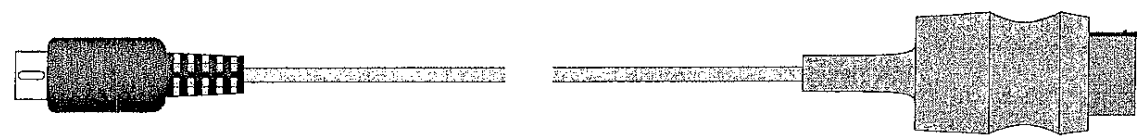

mini-DIN Connector

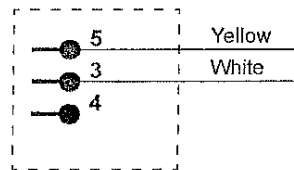

Oxford Connector

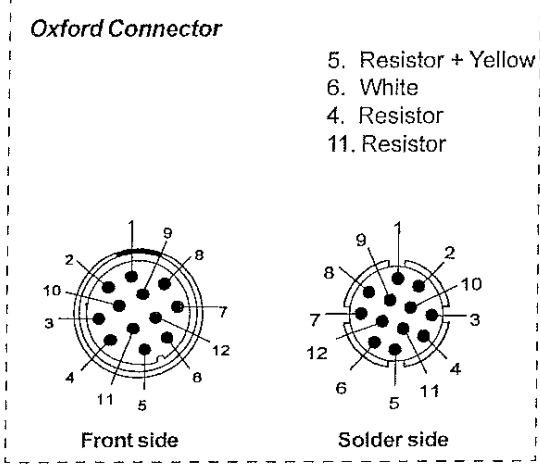
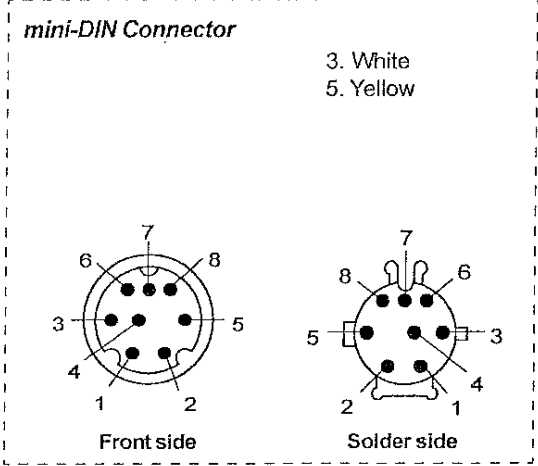
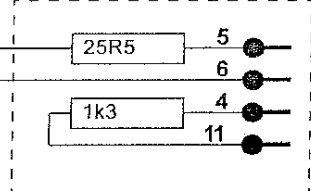

<p>PROPRIETARY NOTICE</p> <p>THIS DOCUMENT CONTAINS INFORMATION PROPRIETARY TO THE FLUKE CORPORATION, AND SHALL NOT BE USED FOR ENGINEERING DESIGN, PROCUREMENT, OR MANUFACTURE IN WHOLE OR IN PART WITHOUT EXPRESS WRITTEN CONSENT OF THE FLUKE CORPORATION.</p>			<p>FLUKE CORPORATION P.O. BOX 9090 EVERETT, WASHINGTON 98206-9090</p>	
	<p>Unless otherwise specified, dimensions are in inches, tolerances are: Decimals: .XX±.015 .XXX±.005 Angles: ±1° Fractions: ±1/32 Finish: 63 ✓ Remove all burrs & break sharp edges .005 to .015</p>	<p>Drawn by <i>M. Hult</i> Engineer</p>	<p>Date 1/22/08</p>	<p>Title 17491, OXFORD ULTRASND SIMU CABLE 2.0MHZ (BLUE) PS-320</p>
	<p>Approved <i>[Signature]</i></p>	<p>QA <i>[Signature]</i></p>	<p>Scale 1/1</p>	<p>Do Not Scale</p>
			<p>Size B</p>	<p>Cage No 1JZH3</p>
			<p>Dwg No 2462562</p>	<p>Rev 2</p>
			<p>Sheet 1 Of 1</p>	

Rev	ECN No.
2	10203

This drawing is the property of Fluke Biomedical, neither the drawing, nor reproductions of it, nor information derived from it is to be given to others. No use is to be made of it which is, or may be injurious to the Fluke Corporation.

NOTES:

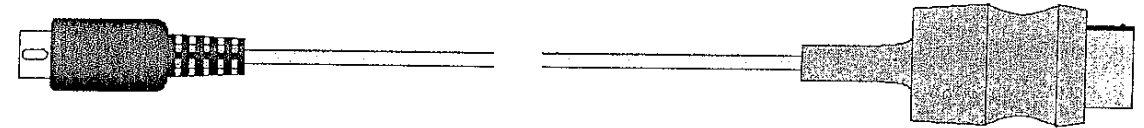

mini-DIN Connector

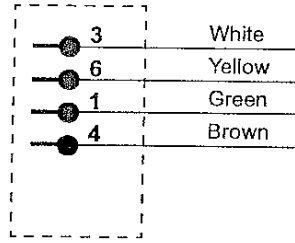

Oxford Connector

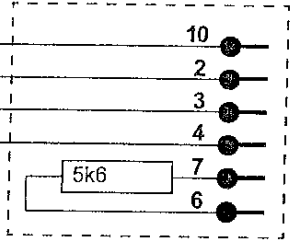

mini-DIN Connector

- 1. Green
- 3. White
- 4. Brown
- 6. Yellow

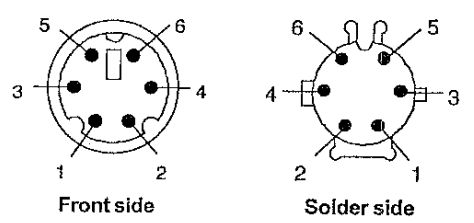

Oxford Connector

- 2. Yellow
- 3. Green
- 4. Brown
- 6. Resistor
- 7. Resistor
- 10. White

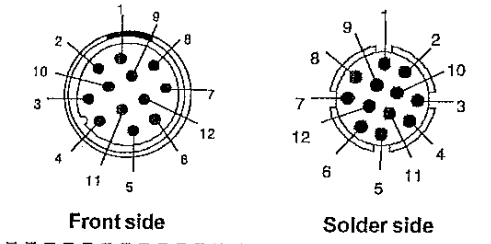

PROPRIETARY NOTICE

THIS DOCUMENT CONTAINS INFORMATION PROPRIETARY TO THE FLUKE CORPORATION, AND SHALL NOT BE USED FOR ENGINEERING DESIGN, PROCUREMENT, OR MANUFACTURE IN WHOLE OR IN PART WITHOUT EXPRESS WRITTEN CONSENT OF THE FLUKE CORPORATION.



FLUKE CORPORATION
P.O. BOX 9090
EVERETT, WASHINGTON 98206-9090

Unless otherwise specified, dimensions are in inches, tolerances are:
Decimals: .XX±.015 .XXX±.005
Angles: ±1° Fractions: ±1/32 Finish: 63 ✓
Remove all burrs & break sharp edges .005 to .015

Drawn by <i>M. Helt</i>	Date 1/22/08
Engineer <i>[Signature]</i>	1/22/09
Approved <i>[Signature]</i>	
QA <i>[Signature]</i>	1/25/08

Title
17492, OXFORD TOCO IUP
SIMULATION CABLE
PS-320

Size B	Cage No 1JZH3	Dwg No 2462570	Rev 2
Scale 1/1	Do Not Scale	Sheet 1	Of 1

Oxford - Ultrasound Cable 1.5MHz (Yellow)

PS-320

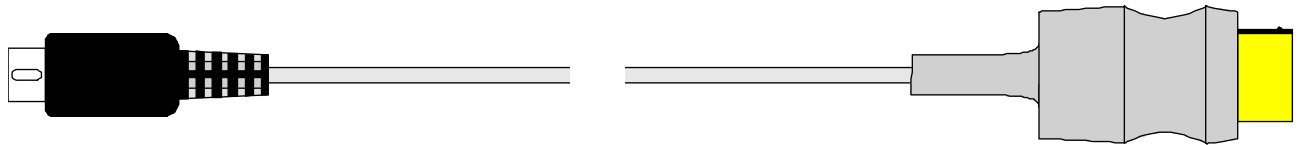

mini-DIN Connector

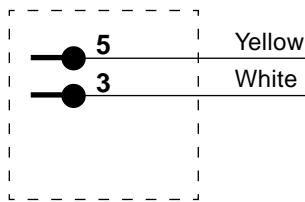

Oxford Connector

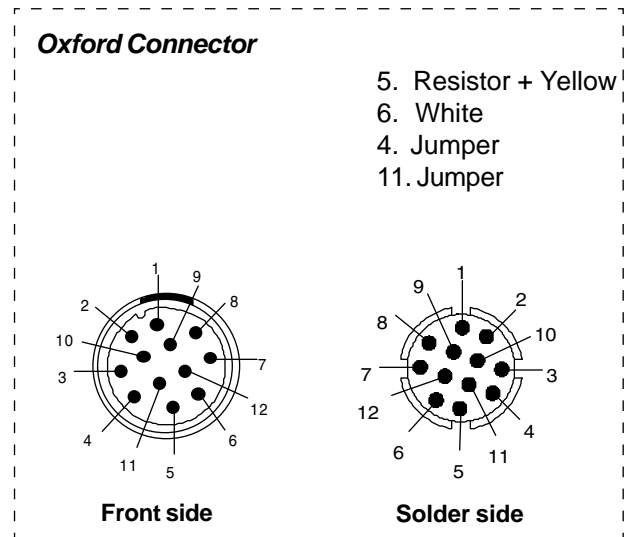
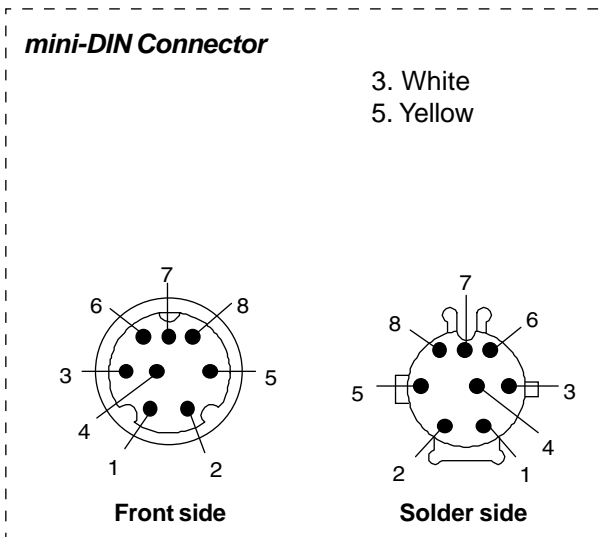
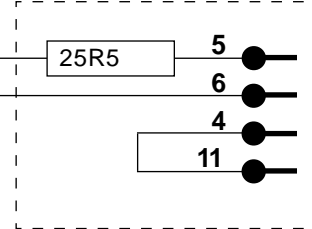

Order no.: 17490

Component list:

- mini-DIN Connector: male, 8 pole, black
- Oxford Connector: Yellow
- Cable: LIYY 6 x 0.14 mm², 1.75 m, grey
- Resistor: 25R5 1% 1 ea

Metron AS
 Vegamot 8
 N-7048 Trondheim, NORWAY
 Phone: +47 73 95 47 00
 Fax: +47 73 95 47 01
 E-mail: support@metron.no

METRON AS Norway	DESCRIPTION Oxford - Ultrasound Cable	
	DRAW CAT. Schematic diagram	
	DRAW NO. -	
PRODUCT PS-320	DATE 05.08.2002	PAGE 1 of 1

Oxford - Ultrasound Cable 2.0MHz (Blue)

PS-320

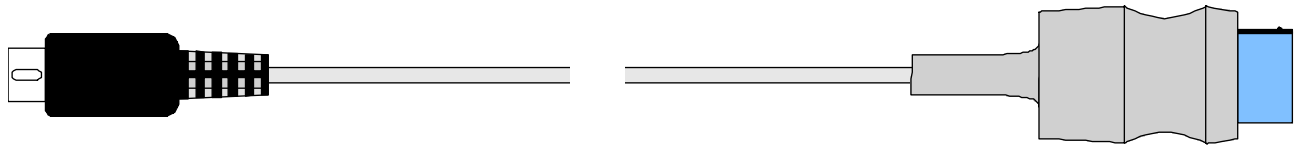

mini-DIN Connector

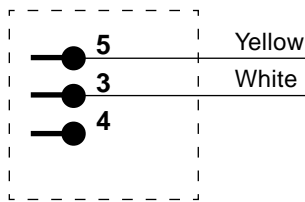

Oxford Connector

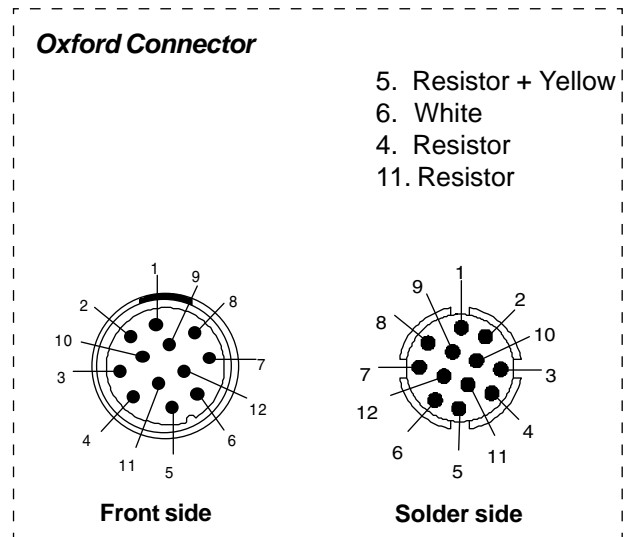
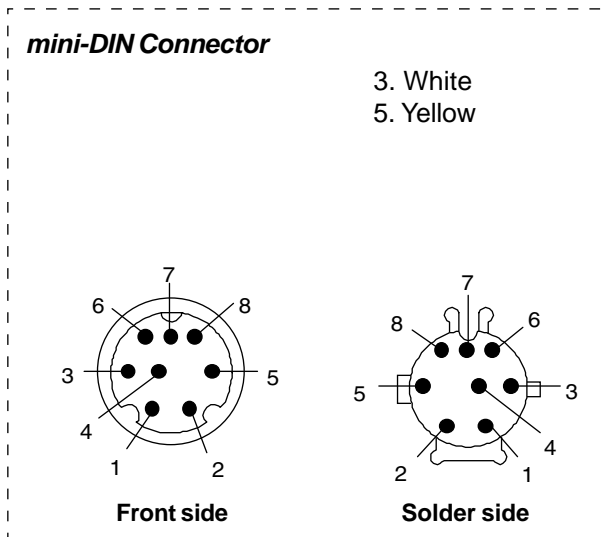
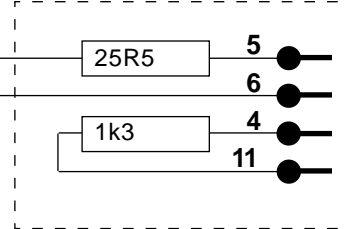

Order no.: 17491

Component list:

- mini-DIN Connector: male, 8 pole, black
- Oxford Connector: Blue
- Cable: LIYY 6 x 0.14 mm², 1.75 m, grey
- Resistor: 1k3 1% 1 ea
- Resistor: 25R5 1% 1 ea

Metron AS
 Vegamot 8
 N-7048 Trondheim, NORWAY
 Phone: +47 73 95 47 00
 Fax: +47 73 95 47 01
 E-mail: support@metron.no

METRON AS Norway	DESCRIPTION Oxford - Ultrasound Cable	
	DRAW CAT. Schematic diagram	
	DRAW NO. -	
PRODUCT PS-320	DATE 05.08.2002	PAGE 1 of 1

PS-320 Oxford Toco - IUP Cable (Pink)

Mod.: SONICAID

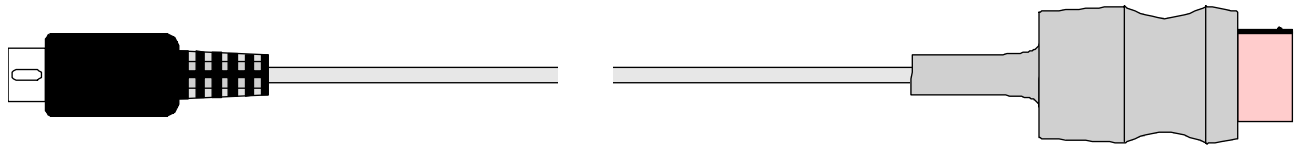

mini-DIN Connector

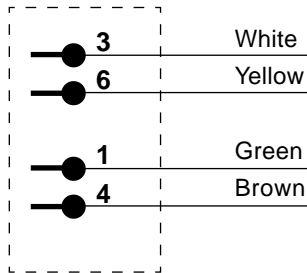

Oxford Connector

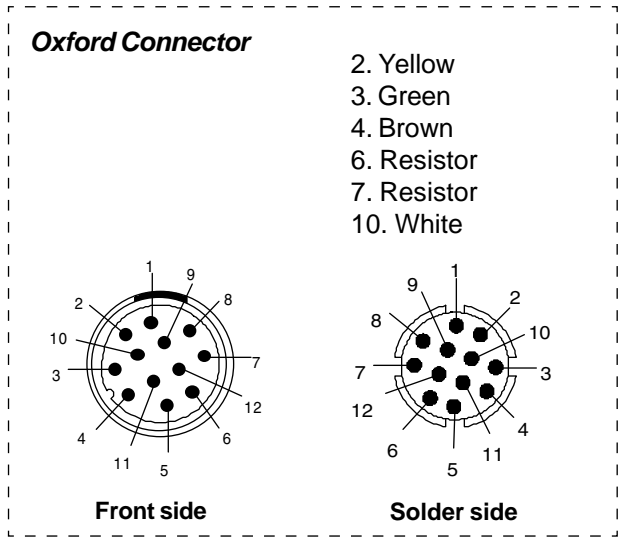
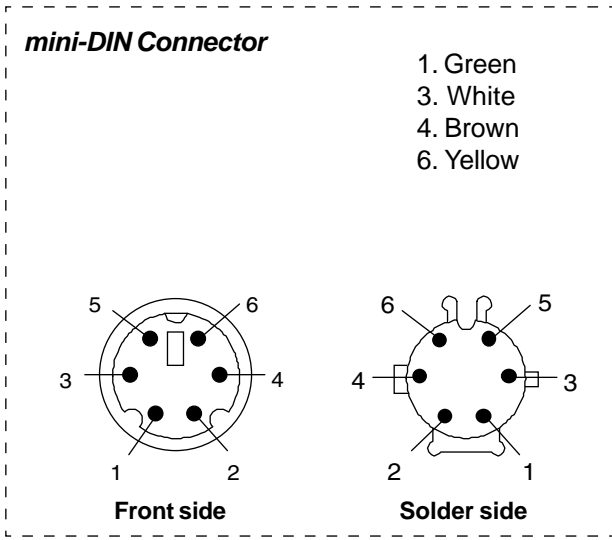
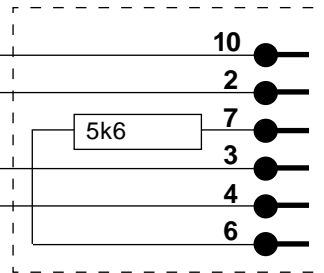

Order no.: 17492

Component list:

- mini-DIN Connector: male, 6 pole, black
- Oxford Connector: Pink
- Cable: LIYY 6 x 0.14 mm², 1.75 m, grey
- Resistor: 5k6 1% 1 ea

Metron AS
 Vegamot 8
 N-7048 Trondheim, NORWAY
 Phone: +47 73 95 47 00
 Fax: +47 73 95 47 01
 E-mail: support@metron.no

METRON AS Norway	DESCRIPTION Oxford Toco - IUP Cable	
	DRAW CAT. Schematic diagram	
	DRAW NO. -	
PRODUCT PS-320	DATE 09.04.2003	PAGE 1 of 1

PS-320 Oxford - Ultrasound Cable 1.5MHz

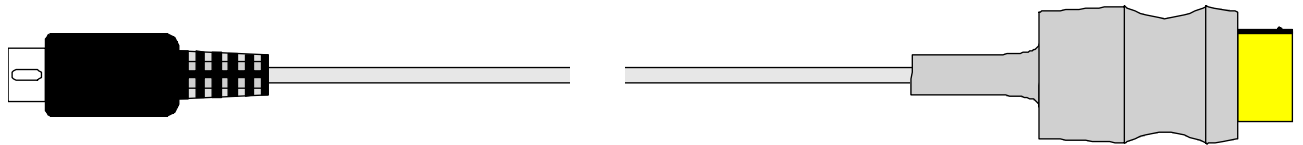

mini-DIN Connector

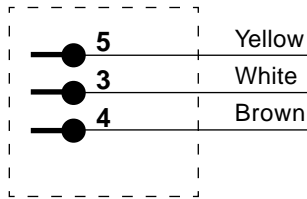

Oxford Connector

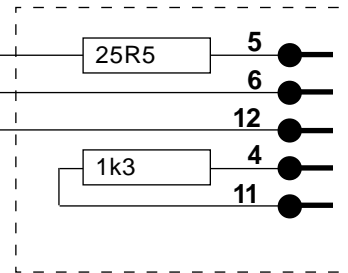

mini-DIN Connector

- 3. White
- 4. Brown
- 5. Yellow

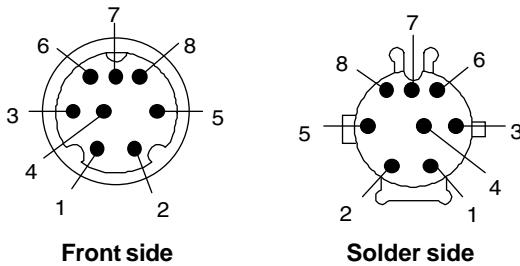

Oxford Connector

- 5. Resistor + Yellow
- 6. White
- 12. Brown
- 4. Resistor
- 11. Resistor

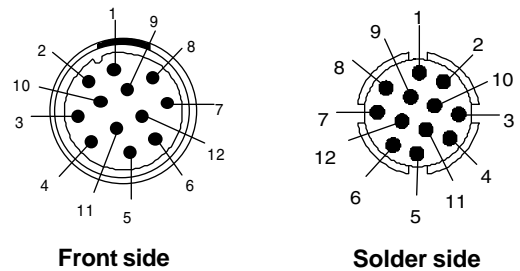

Order no.: 17490

Component list:

- mini-DIN Connector: male, 8 pole, black
- Oxford Connector: Yellow
- Cable: LIYY 6 x 0.14 mm², 1.75 m, grey
- Resistor: 25R5 1% 1 ea
- Resistor: 1k3 1% 1 ea

Metron AS
 Vegamot 8
 N-7048 Trondheim, NORWAY
 Phone: +47 73 95 47 00
 Fax: +47 73 95 47 01
 E-mail: support@metron.no

METRON AS Norway	DESCRIPTION PS-320 Oxford - Ultrasound Cable	
	DRAW CAT. Schematic diagram	
	DRAW NO. -	
PRODUCT PS-320	DATE 02.09.2004	PAGE 1 of 1

PS-320 Oxford - Ultrasound Cable 2.0MHz

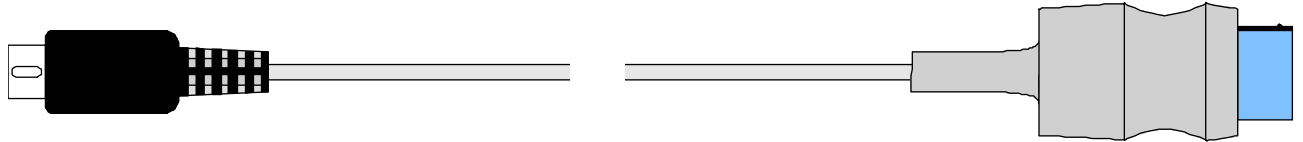

mini-DIN Connector

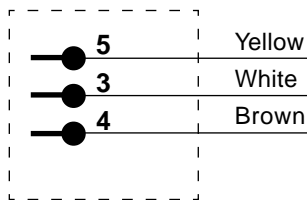

Oxford Connector

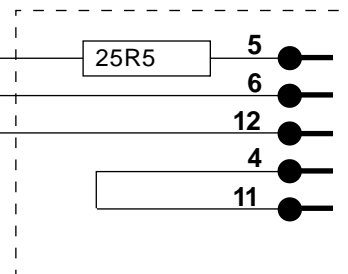

mini-DIN Connector

- 3. White
- 4. Brown
- 5. Yellow

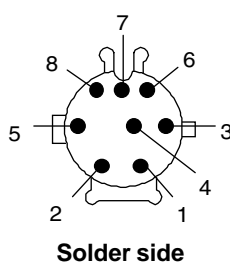
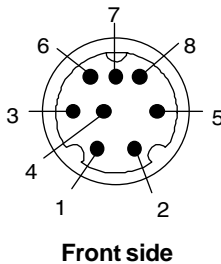

Oxford Connector

- 5. Resistor + Yellow
- 6. White
- 12. Brown
- 4. Jumper
- 11. Jumper

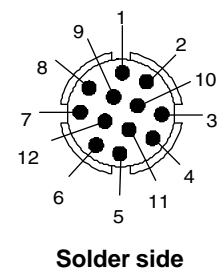
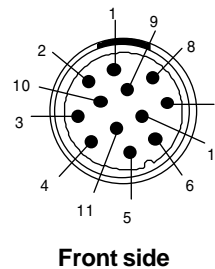

Order no.: 17491

Component list:

- mini-DIN Connector: male, 8 pole, black
- Oxford Connector: Blue
- Cable: LIYY 6 x 0.14 mm², 1.75 m, grey
- Resistor: 25R5 1% 1 ea

Metron AS
 Vegamot 8
 N-7048 Trondheim, NORWAY
 Phone: +47 73 95 47 00
 Fax: +47 73 95 47 01
 E-mail: support@metron.no

METRON AS Norway	DESCRIPTION PS-320 Oxford - Ultrasound Cable	
	DRAW CAT. Schematic diagram	
	DRAW NO. -	
PRODUCT PS-320	DATE 02.09.2004	PAGE 1 of 1

PS-320 Oxford Toco - IUP Cable (Pink)

Mod.: SONICAID

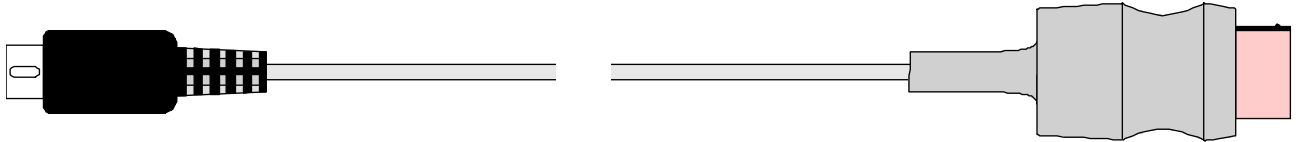

mini-DIN Connector

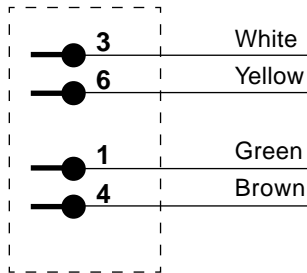

Oxford Connector

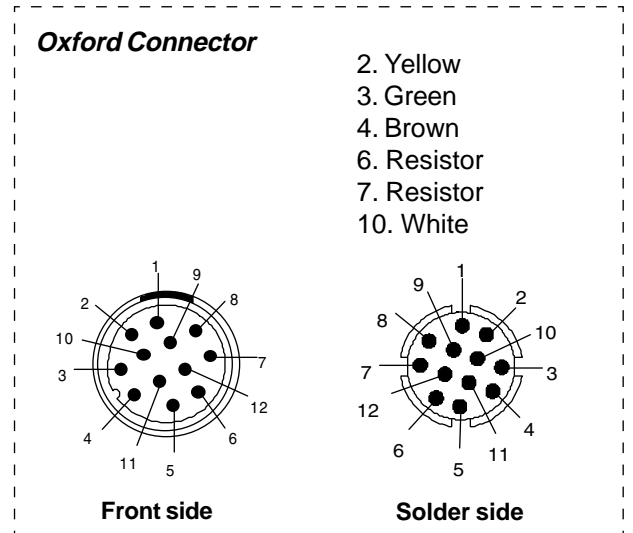
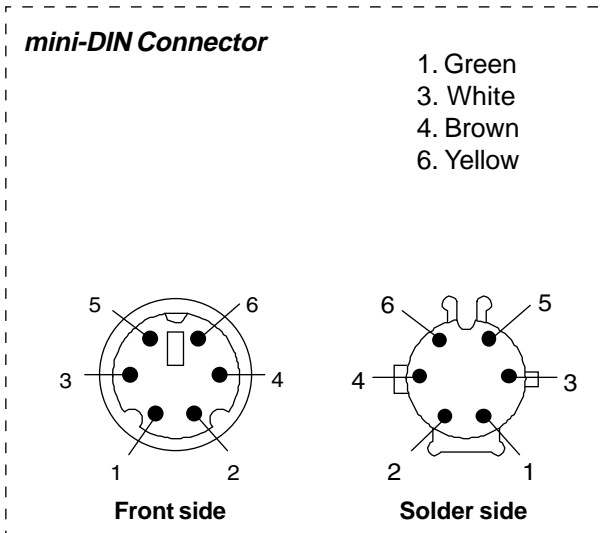
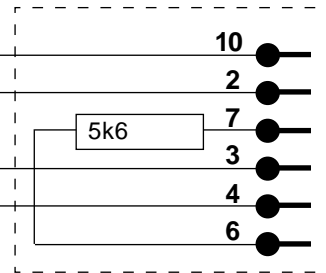

Order no.: 17492

Component list:

- mini-DIN Connector: male, 6 pole, black
- Oxford Connector: Pink
- Cable: LIYY 6 x 0.14 mm², 1.75 m, grey
- Resistor: 5k6 1% 1 ea

Metron AS
 Vegamot 8
 N-7048 Trondheim, NORWAY
 Phone: +47 73 95 47 00
 Fax: +47 73 95 47 01
 E-mail: support@metron.no

METRON AS Norway	DESCRIPTION Oxford Toco - IUP Cable	
	DRAW CAT. Schematic diagram	
	DRAW NO. -	
PRODUCT PS-320	DATE 09.04.2003	PAGE 1 of 1

PS-320 Oxford Toco - IUP Cable

Mod.: SONICAID

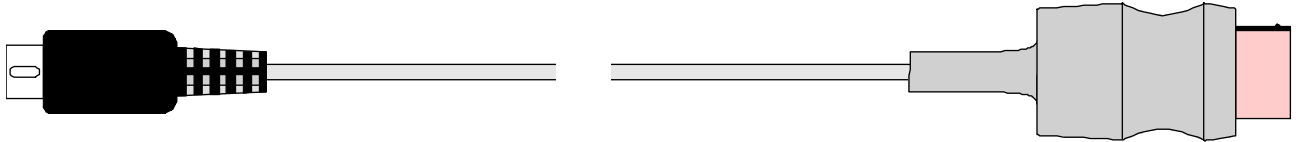

mini-DIN Connector

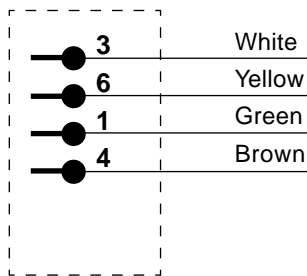

Oxford Connector

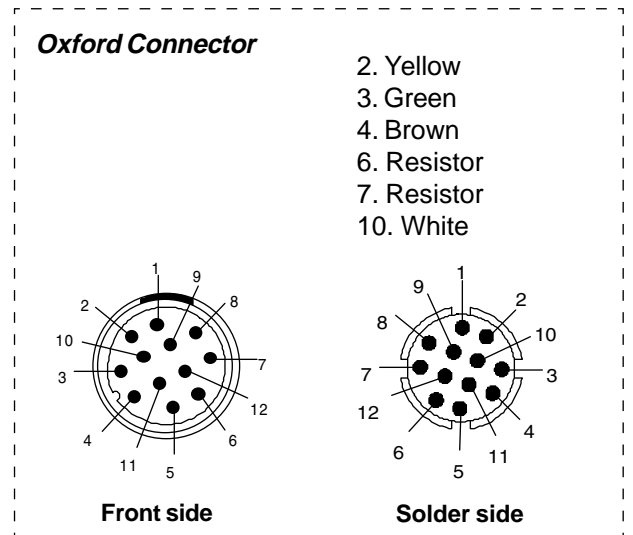
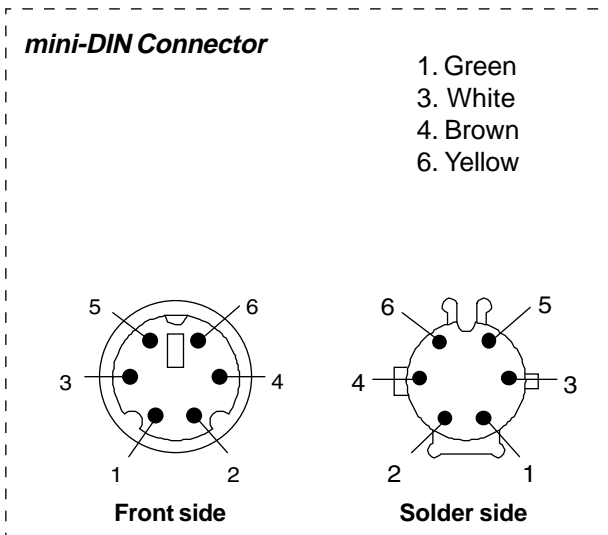
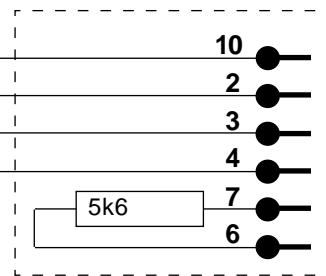

Order no.: 17492

Component list:

- mini-DIN Connector: male, 6 pole, black
- Oxford Connector: Pink
- Cable: LIYY 6 x 0.14 mm², 1.75 m, grey
- Resistor: 5k6 1% 1 ea

Metron AS
 Vegamot 8
 N-7048 Trondheim, NORWAY
 Phone: +47 73 95 47 00
 Fax: +47 73 95 47 01
 E-mail: support@metron.no

METRON AS Norway	DESCRIPTION PS-320 Oxford Toco - IUP Cable	
	DRAW CAT. Schematic diagram	
	DRAW NO. -	
PRODUCT PS-320	DATE 28.07.2004	PAGE 1 of 1

Corometrics Toco - External Cable

PS-320

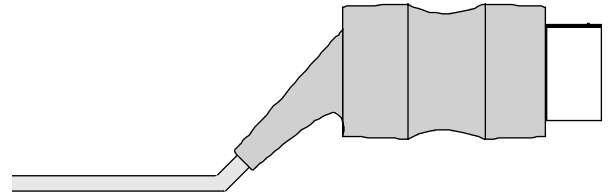
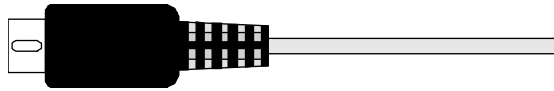

mini-DIN
Connector

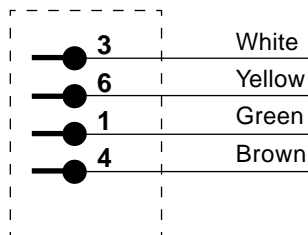

Corometrics
Connector

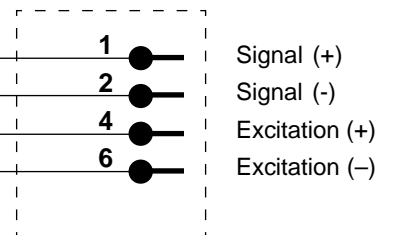

mini-DIN Connector

- 1. Green
- 3. White
- 4. Brown
- 6. Yellow

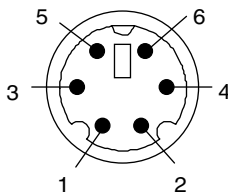

Front side

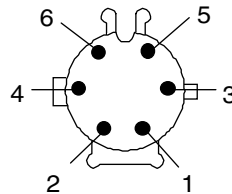

Solder side

Corometrics Connector

- 1. White
- 2. Yellow
- 4. Green
- 6. Brown

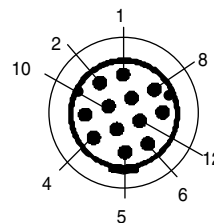

Front side

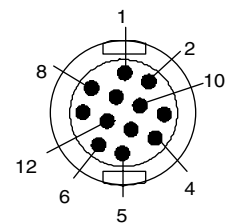

Solder side

Order no.: 17481

Component list:

mini-DIN Connector: male, 6 pole, black
 Corometrics Conn.: KT-017B
 Cable: LIYY 6 x 0.14 mm², 1.75 m, grey

Metron AS
 Vegamot 8
 N-7048 Trondheim, NORWAY
 Phone: +47 73 95 47 00
 Fax: +47 73 95 47 01
 E-mail: support@metron.no

METRON AS Norway	DESCRIPTION Corometrics Toco - External Cable	
	DRAW CAT. Schematic diagram	
	DRAW NO. -	
PRODUCT PS-320	DATE 06.10.2001	PAGE 1 of 1

PS-320 Agilent - Ultrasound Cable

Agilent M1350B (50XM), M1350C (50XMO), M1353A (50 IP-2), M1353A (50 IP), (Only on Cardio 1)



mini-DIN Connector

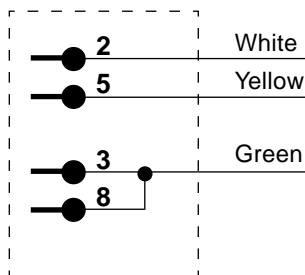

Agilent Connector

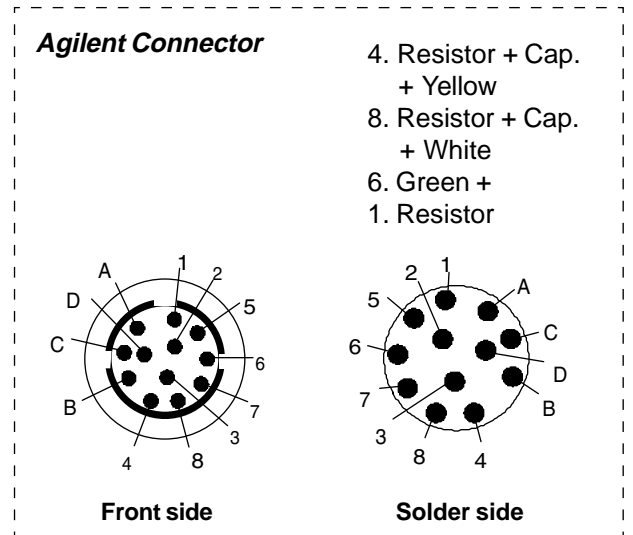
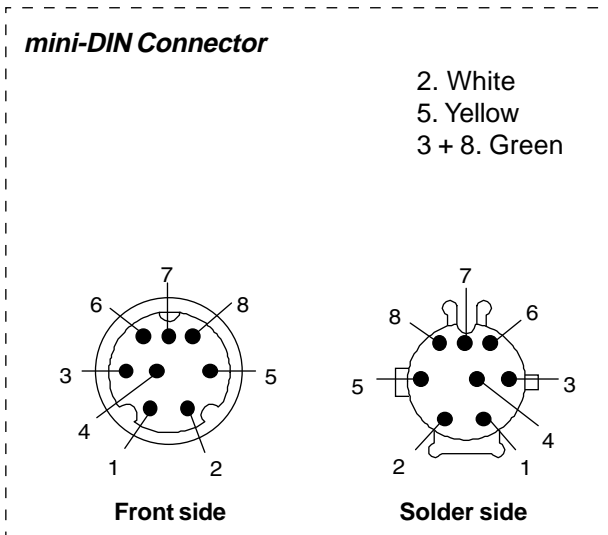
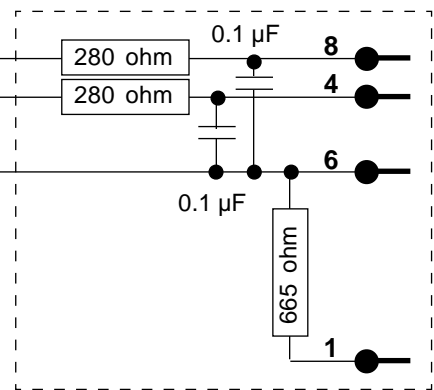

Order no.: 17482

Component list:

- mini-DIN Connector: male, 8 pole, black
- Agilent Connector: PN 1252-4830 (Rose)
- Cable sleeve: 120600 Skindicht - SNR 7/5
- Cable: LIYY 6 x 0.14 mm², 1.75 m, grey
- Resistor: 280 ohms 1% 2 ea
- Resistor: 665 ohms 1% 1 ea
- Capacitors: Cer. 0.1 µF 10% 2 ea

Metron AS
 Vegamot 8
 N-7048 Trondheim, NORWAY
 Phone: +47 73 95 47 00
 Fax: +47 73 95 47 01
 E-mail: support@metron.no

METRON AS Norway	DESCRIPTION PS-320 Agilent - Ultrasound Cable	
	DRAW CAT. Schematic diagram	
	DRAW NO. -	
PRODUCT PS-320	DATE 28.07.2004	PAGE 1 of 1

PS-320 Corometrics - Ultrasound Cable

Model 116, 151



mini-DIN Connector

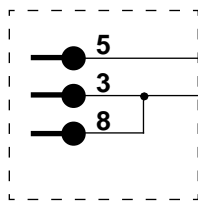

Yellow
Green

Corometrics Connector

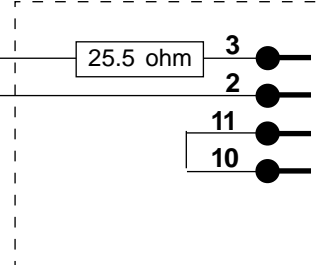

US1
Common

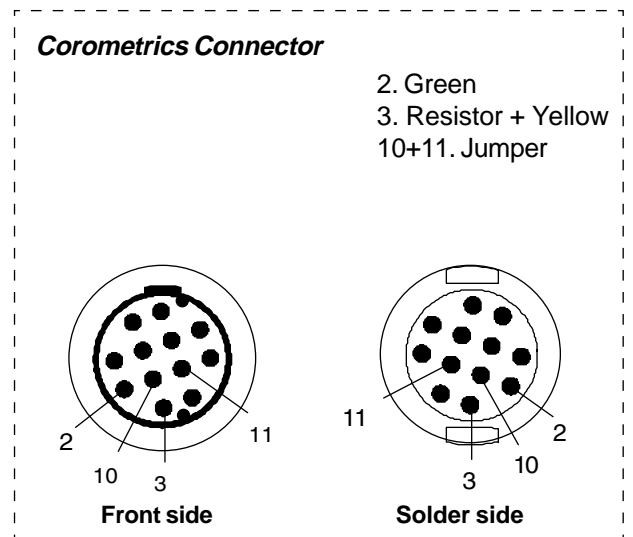
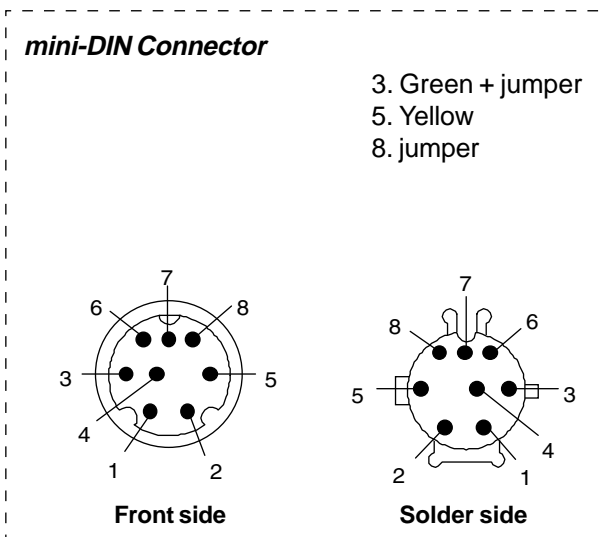

Order no.: 17483

Component list:

- mini-DIN Connector: male, 8 pole, black
- Corometrics Conn.: KT-021B
- Cable: LIYY 6 x 0.14 mm², 1.75 m, grey
- Resistor: 25.5 ohm 1% 1 ea

Metron AS
 Vegamot 8
 N-7048 Trondheim, NORWAY
 Phone: +47 73 95 47 00
 Fax: +47 73 95 47 01
 E-mail: support@metron.no

METRON AS Norway	DESCRIPTION Corometric - Ultrasound Cable	
	DRAW CAT. Schematic diagram	
	DRAW NO. -	
PRODUCT PS-320	DATE 04.10.2002	PAGE 1 of 1

PS-320 Agilent Toco - External Cable

Agilent M1350B/C, M1353A (50 IP-2)

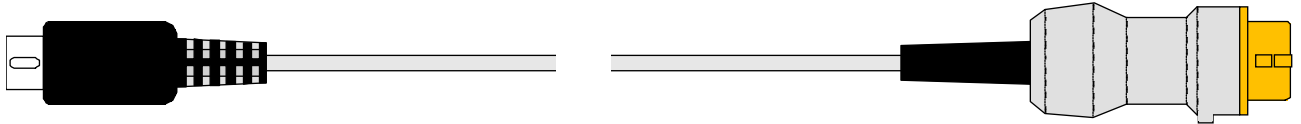

mini-DIN Connector

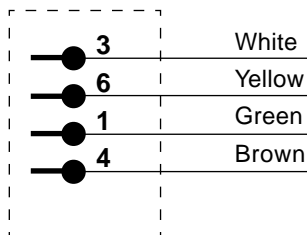

Agilent Connector

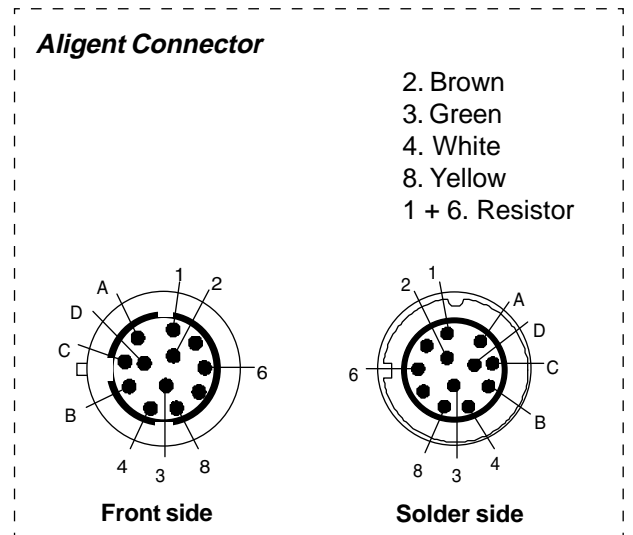
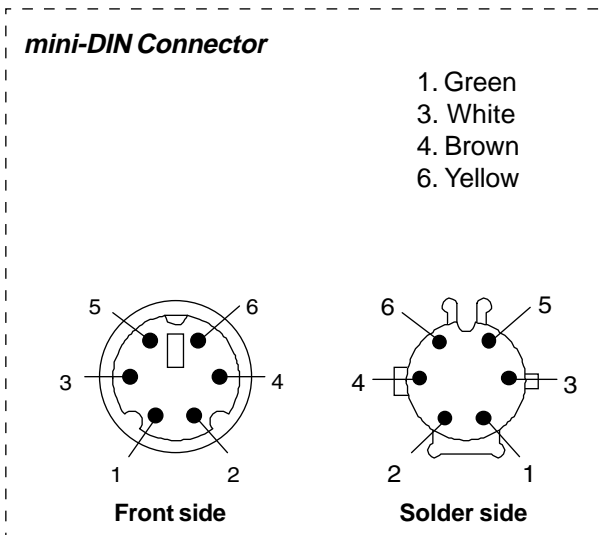
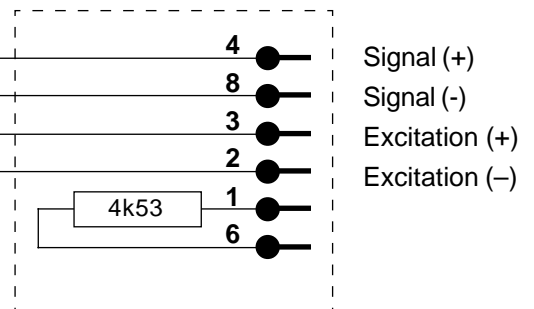

Order no.: 17484

Component list:

- mini-DIN Connector: male, 6 pole, black
- Agilent Connector: PN 1251-6887 (brown)
- Cable sleeve: 120600 Skindicht - SNR 7/5
- Cable: LIYY 6 x 0.14 mm², 1.75 m, grey
- Resistor: 4k53 1%

Metron AS
 Vegamot 8
 N-7048 Trondheim, NORWAY
 Phone: +47 73 95 47 00
 Fax: +47 73 95 47 01
 E-mail: support@metron.no

METRON AS Norway	DESCRIPTION PS-320 Agilent Toco - External Cable	
	DRAW CAT. Schematic diagram	
	DRAW NO. -	
PRODUCT PS-320	DATE 28.07.2004	PAGE 1 of 1

PS-320 Corometrics Toco - IUP Cable

Model 116

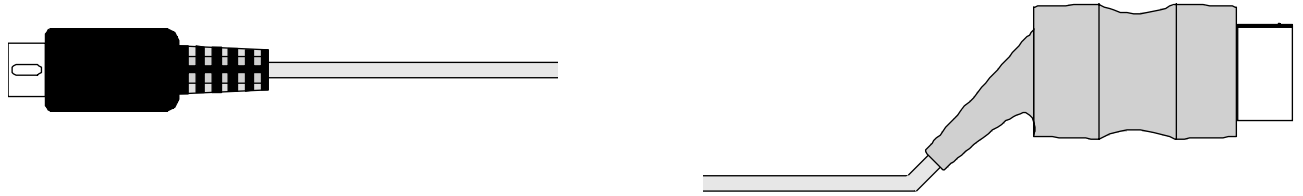

mini-DIN Connector

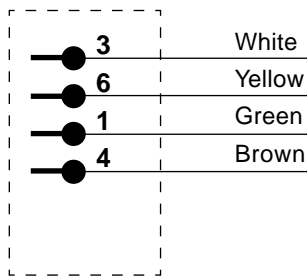

Corometrics Connector

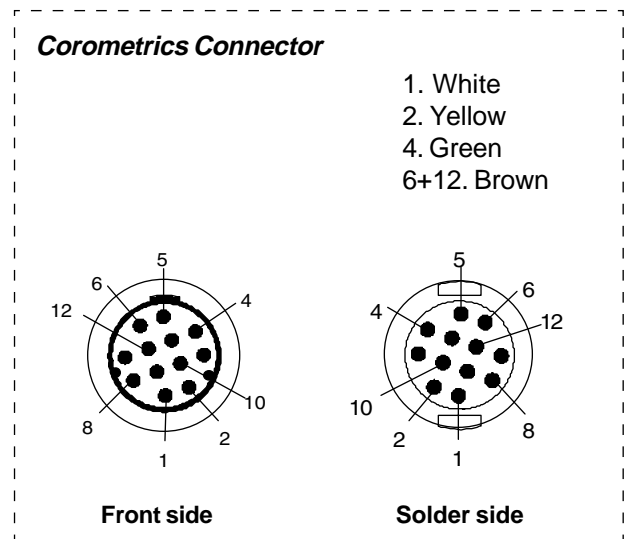
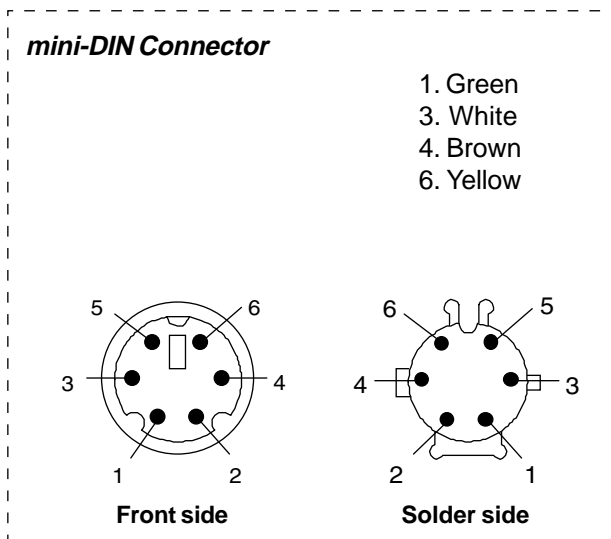
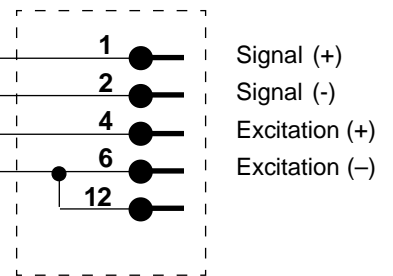

Order no.: 17486

Component list:

mini-DIN Connector: male, 6 pole, black
 Corometrics Conn.: KT-017B
 Cable: LIYY 6 x 0.14 mm², 1.75 m, grey

Metron AS
 Vegamot 8
 N-7048 Trondheim, NORWAY
 Phone: +47 73 95 47 00
 Fax: +47 73 95 47 01
 E-mail: support@metron.no

METRON AS Norway	DESCRIPTION Corometrics Toco - IUP Cable	
	DRAW CAT. Schematic diagram	
	DRAW NO. -	
PRODUCT PS-320	DATE 12.07.2002	PAGE 1 of 1

Agilent 50 & 8040 Series Toco - IUP Cable

PS-320

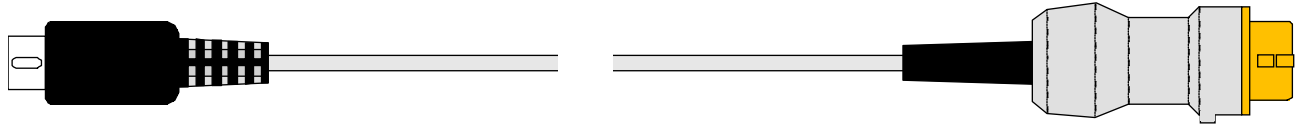

mini-DIN Connector

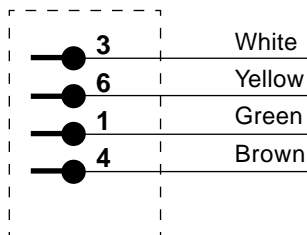

Agilent Connector

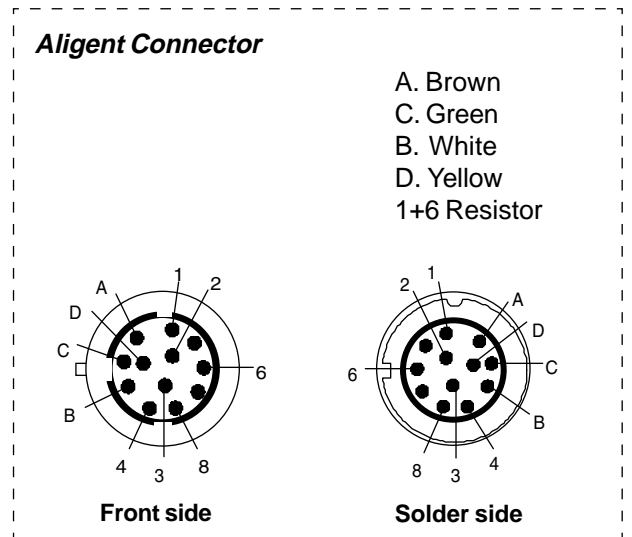
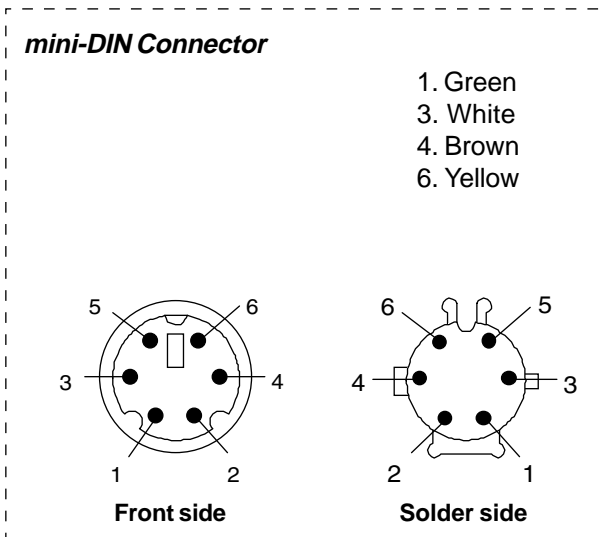
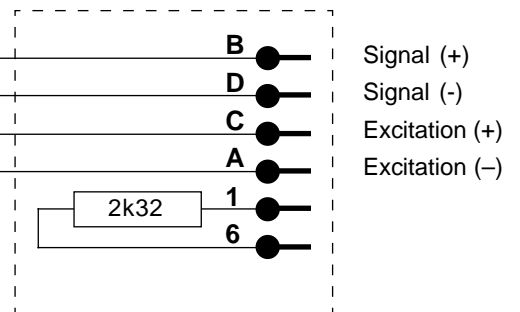

Order no.: 17487

Component list:

- mini-DIN Connector: male, 6 pole, black
- Agilent Connector: PN 1251-6887 (brown)
- Cable sleeve: 120600 Skindicht - SNR 7/5
- Cable: LIYY 6 x 0.14 mm², 1.75 m, grey
- Resistor: 2k32 1%

Metron AS
 Vegamot 8
 N-7048 Trondheim, NORWAY
 Phone: +47 73 95 47 00
 Fax: +47 73 95 47 01
 E-mail: support@metron.no

METRON AS Norway	DESCRIPTION Agilent 50 & 8040 Series Toco - IUP Cable	
	DRAW CAT. Schematic diagram	
	DRAW NO. -	
PRODUCT PS-320	DATE 05.09.2001	PAGE 1 of 1

Agilent 8040 - Ultrasound Cable

PS-320



mini-DIN Connector

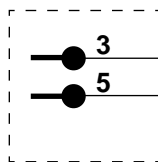

3 White
5 Yellow

Agilent Connector

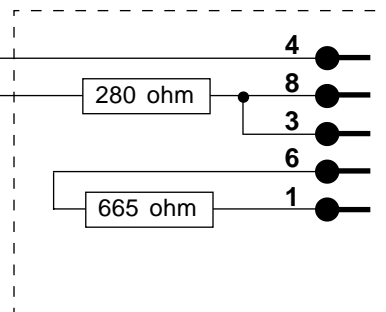

4 Common
8 US1
3
6
1

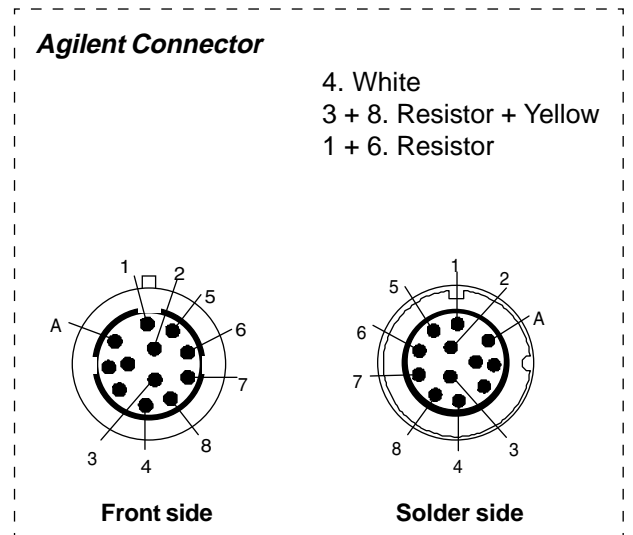
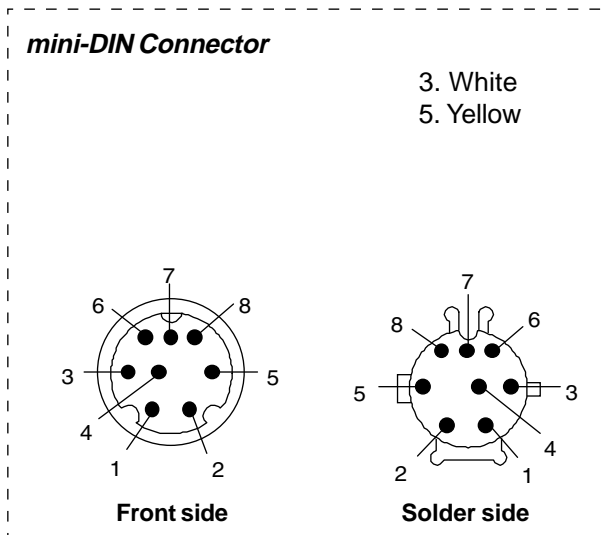

Order no.: 17488

Component list:

- mini-DIN Connector: male, 8 pole, black
- Agilent Connector: PN 1252-2700 (Blue)
- Cable sleeve: 120600 Skindicht - SNR 7/5
- Cable: LIYY 6 x 0.14 mm², 1.75 m, grey
- Resistor: 280 ohms 1%
- Resistor: 665 ohms 1%

Metron AS
 Vegamot 8
 N-7048 Trondheim, NORWAY
 Phone: +47 73 95 47 00
 Fax: +47 73 95 47 01
 E-mail: support@metron.no

METRON AS Norway	DESCRIPTION Agilent 8040 - Ultrasound Cable	
	DRAW CAT. Schematic diagram	
	DRAW NO. -	
PRODUCT PS-320	DATE 04.10.2002	PAGE 1 of 1

Agilent 8040 - External Toco

PS-320

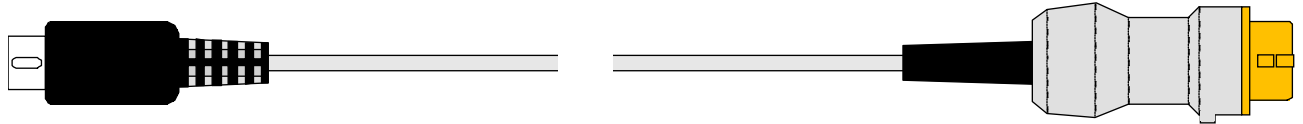

mini-DIN Connector

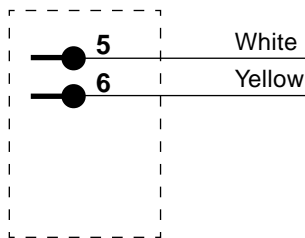

Agilent Connector

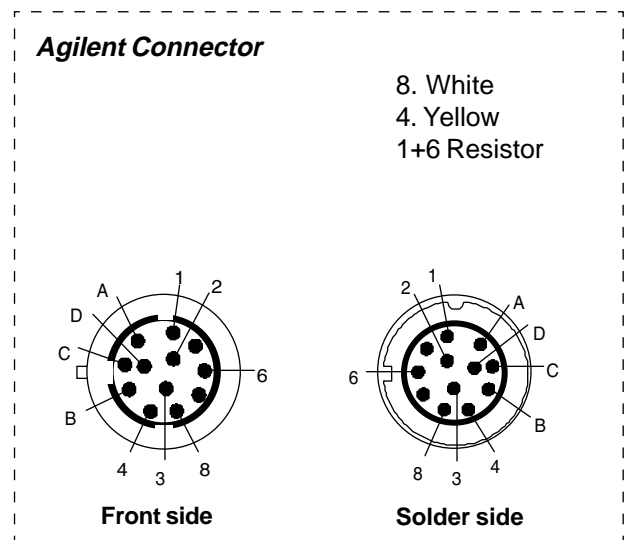
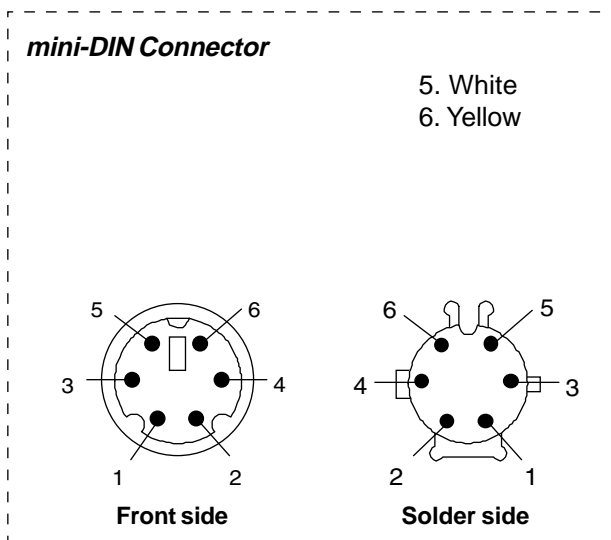
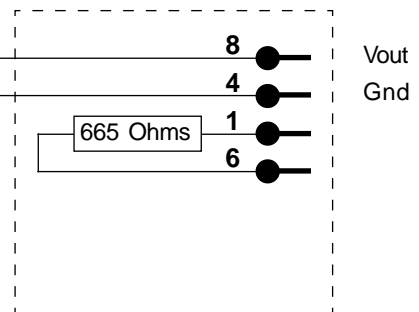

Order no.: 17489

Component list:

- mini-DIN Connector: male, 6 pole, black
- Agilent Connector: PN 1251-6887 (brown)
- Cable sleeve: 120600 Skindicht - SNR 7/5
- Cable: LIYY 6 x 0.14 mm², 1.75 m, grey
- Resistor: 665 Ohms 1%

Metron AS
 Vegamot 8
 N-7048 Trondheim, NORWAY
 Phone: +47 73 95 47 00
 Fax: +47 73 95 47 01
 E-mail: support@metron.no

METRON AS Norway	DESCRIPTION Agilent 8040 - External Toco	
	DRAW CAT. Schematic diagram	
	DRAW NO. -	
PRODUCT PS-320	DATE 05.09.2001	PAGE 1 of 1