



**Datrend  
Systems Inc.**

# Oxitest *Plus 7*

*Pulse Oximeter Tester*

Operating Manual



Oxitest Plus7  
*Pulse Oximeter Tester*  
Operating Manual

---

© 2003-2010 Datrend Systems Inc.  
Unit #1 - 3531 Jacombs Road  
Richmond, BC • Canada • V6V 1Z8  
Tel 604.291.7747 or 800.667.6557  
Fax 604.294.2355  
e-mail [customerservice@datrend.com](mailto:customerservice@datrend.com)





To order this manual, use Part Number 6100-105

| Revision | Revision History Description                      | Date        |
|----------|---|-------------|
| C        | - 5 year warranty<br>- Ver. 2: "Adjust SpO2" menu | 2009-Dec-22 |

---

### Copyright

Datrend Systems Inc. ("DSI") agrees to a limited copyright release that allows you to reproduce manuals and other printed materials for use in service training programs and other technical publications. If you would like other reproductions or distributions, submit a written request to Datrend Systems Inc.

---

### Unpacking and Inspection

Follow standard receiving practices upon receipt of the instrument. Check the shipping carton for damage. If damage is found, stop unpacking the instrument. Notify the freight carrier and ask for an agent to be present while the instrument is unpacked. There are no special unpacking instructions, but be careful not to damage the instrument when unpacking it. Inspect the instrument for physical damage such as bent or broken parts, dents, or scratches.

---

### Claims

Our routine method of shipment is via common carrier. Upon delivery, if physical damage is found, retain all packing materials in their original condition and contact the carrier immediately to file a claim.

If the instrument is delivered in good physical condition but does not operate within specifications, or if there are any other problems not caused by shipping damage, please contact your local sales representative or DSI immediately.

---

### Standard Terms and Conditions

#### Refunds & Credits

Please note only serialized products (products labeled with a distinct serial number) and accessories are eligible for partial refund and/or credit. Non-serialized parts and accessory items (cables, carrying cases, auxiliary modules, etc.) are not eligible for return or refund. In order to receive a partial refund/credit, the product must not have been damaged, and must be returned complete (meaning all manuals, cables, accessories, etc.) within 90 days of original purchase and in "as new" and resalable condition. The *Return Procedure* must be followed.

#### Return Procedure

Every product returned for refund/credit must be accompanied by a Return Material Authorization (RMA) number, obtained from Datrend Customer Service. All items being returned must be sent prepaid (freight, duty, brokerage, and taxes ) to our factory location.

#### Restocking Charges

Products returned within 30 days of original purchase are subject to a minimum restocking fee of 15%. Products returned in excess of 30 days after purchase, but prior to 90 days, are subject to a minimum restocking fee of 20%. Additional charges for damage and/or missing parts and accessories will be applied to all returns. Products which are not in "as new" and resalable condition, are not eligible for credit return and will be returned to the customer at their expense.

---

### Certification

This instrument was thoroughly tested and inspected and found to meet DSI's manufacturing specifications when it was shipped from the factory. Calibration measurements are traceable to the National Research Council of Canada (NRC) and/or the National Institute of Standards and Technology (NIST). Devices for which there are no NRC/NIST calibration standards are measured against in-house performance standards using accepted test procedures.

---

## Warranty

### Warranty and Product Support

Datrend Systems Inc. ("DSI") warrants this instrument to be free from defects in materials and workmanship under normal use and service for one (1) year from the date of original purchase. This warranty will be automatically extended to a **maximum of five (5) years** from the date of original purchase provided that calibration is performed on an **annual** basis by a Datrend Authorized Service Center (refer to Section 6.2 of this manual).

This warranty is subject to the following limitations:

- Oxitest Battery Pack: 90 day limited warranty
- Standard Accessories: 90 day limited warranty
- Re-calibration of the instrument, which has a recommended annual calibration frequency, is not covered under the warranty.

During the warranty period DSI will, at our option, either repair or replace a product that proves to be defective at no charge; provided you return the product (shipping, duty, brokerage and taxes prepaid) to DSI. Any and all transportation charges incurred are the responsibility of the purchaser and are not included within this warranty. This warranty extends only to the original purchaser and does not cover damage from abuse, neglect, accident or misuse or as the result of service or modification by other than DSI. **IN NO EVENT SHALL DATREND SYSTEMS INC. BE LIABLE FOR CONSEQUENTIAL DAMAGES.**

No warranty shall apply when damage is caused by any of the following:

- Power failure, surges, or spikes,
- Damage in transit or when moving the instrument,
- Improper power supply such as low voltage, incorrect voltage, defective wiring or inadequate fuses,
- Accident, alteration, abuse or misuse of the instrument,
- Fire, water damage, theft, war, riot, hostility, acts of God, such as hurricanes, floods, etc.

Only serialized products (those items bearing a distinct serial number tag) and their standard accessory items are covered under this warranty. **PHYSICAL DAMAGE CAUSED BY MISUSE OR PHYSICAL ABUSE IS NOT COVERED UNDER THE WARRANTY.** Items such as cables and non-serialized modules are not covered under this warranty.

This warranty gives you specific legal rights and you may have other rights, which vary from province to province, state to state, or country to country. This warranty is limited to repairing the instrument to DSI's specifications.

When you return a DSI instrument for service, repair or calibration, we recommend shipment using the original shipping foam and container. If the original packing materials are not available, we recommend the following guide for repackaging:

- Use a double-walled carton of sufficient strength for the weight being shipped.
- Use heavy paper or cardboard to protect all instrument surfaces. Use non-abrasive material around all projecting parts.
- Use at least four inches of tightly packed, industrial-approved, shock-absorbent material all around the instrument.

DSI will not be responsible for lost shipments or instruments received in damaged condition due to improper packaging or handling. All warranty claim shipments must be made on a prepaid basis (freight, duty, brokerage, and taxes). No returns will be accepted without a Return Materials Authorization ("RMA) number. Please contact Datrend at 1-800-667-6557 to obtain an RMA number and receive help with shipping/customs documentation.

---

**Warranty Disclaimer**

Should you elect to have your instrument serviced and/or calibrated by someone other than Datrend Systems, please be advised that the original warranty covering your product becomes void when the tamper-resistant Quality Seal is removed or broken without proper factory authorization. We strongly recommend, therefore, that you send your instrument to Datrend Systems for service and calibration, especially during the original warranty period.

In all cases, breaking the tamper-resistant Quality Seal should be avoided at all cost, as this seal is the key to your original instrument warranty. In the event that the seal must be broken to gain internal access to the instrument (e.g., in the case of a customer-installed firmware upgrade), you must first contact Datrend Systems at 1-800-667-6557. You will be required to provide us with the serial number for your instrument as well as a valid reason for breaking the Quality Seal. You should break this seal only after you have received factory authorization. Do not break the Quality Seal before you have contacted us! Following these steps will help ensure that you will retain the original warranty on your instrument without interruption.

---

**WARNING**

Unauthorized user modifications or application beyond the published specifications may result in electrical shock hazards or improper operation. Datrend Systems will not be responsible for any injuries sustained due to unauthorized equipment modifications.

**DSI DISCLAIMS ALL OTHER WARRANTIES, EXPRESSED OR IMPLIED, INCLUDING ANY WARRANTY OF MERCHANTABILITY OR FITNESS FOR A PARTICULAR PURPOSE OR APPLICATION.**

**THIS PRODUCT CONTAINS NO USER-SERVICEABLE COMPONENTS. UNAUTHORIZED REMOVAL OF THE INSTRUMENT COVER SHALL VOID THIS AND ALL OTHER EXPRESSED OR IMPLIED WARRANTIES.**

Nellcor<sup>®</sup> is a registered trademark of Tyco Healthcare

QBasic<sup>™</sup> and Visual Basic<sup>™</sup> are trademarks of Microsoft Corp.

MS-DOS<sup>®</sup> is a registered trademark of Microsoft Corp.

---

## Table of Contents

---

|  |    |
|--|----|
| 1. Specifications . . . . .                                      | 1  |
| 2. Overview . . . . .  | 5  |
| 2.1 General Description . . . . .                                | 5  |
| 2.2 Detailed Description . . . . .                               | 6  |
| 3. Operation . . . . .   | 9  |
| 3.1 General Description . . . . .                                | 9  |
| 3.2 Powering Up, and Modifying the Oxitest Plus 7 Menu . . . . . | 11 |
| 3.3 Setting Display Contrast . . . . .                           | 12 |
| 3.4 Choosing an Oximeter . . . . .                               | 13 |
| 3.5 Selecting an SpO <sub>2</sub> level . . . . .                | 14 |
| 3.6 Selecting a Heart Rate . . . . .                             | 15 |
| 3.7 Selecting a Pulse Amplitude . . . . .                        | 15 |
| 3.8 Status Indicator . . . . .                                   | 16 |
| 3.9 Selecting Motion Artifact Simulation . . . . .               | 17 |
| 3.10 Selecting Auto Presets . . . . .                            | 18 |
| 3.11 Selecting Alarm Tests . . . . .                             | 18 |
| 3.12 Saving and Printing Test Results . . . . .                  | 22 |
| 3.13 Using the Nellcor Sensor Port . . . . .                     | 24 |
| 3.14 ECG Trigger Output . . . . .                                | 26 |
| 3.15 Recharging the Battery . . . . .                            | 27 |
| 4. Computer Control and RS-232 . . . . .                         | 29 |
| 4.1 Electrical Interface . . . . .                               | 29 |
| 4.2 Mechanical Interface . . . . .                               | 30 |
| 4.3 Functional Description . . . . .                             | 30 |
| 4.4 Command Definitions . . . . .                                | 31 |
| 4.4.1 Select Oximeter and Initialize Simulation . . . . .        | 31 |
| 4.4.2 Set SpO <sub>2</sub> Command . . . . .                     | 32 |
| 4.4.3 Set Heart Rate Command . . . . .                           | 32 |
| 4.4.4 Set Pulse Amplitude Command . . . . .                      | 32 |
| 4.4.5 Activate Artifact Simulation . . . . .                     | 33 |
| 4.4.6 Activate Auto Preset Protocol . . . . .                    | 33 |
| 4.4.7 Download Test Report . . . . .                             | 33 |
| 4.4.8 Download Manual Record . . . . .                           | 34 |
| 4.4.9 Download Auto Preset Test Record . . . . .                 | 34 |
| 4.4.10 Download Alarm Test Record . . . . .                      | 34 |
| 4.4.11 Erase All Test Records . . . . .                          | 34 |
| 4.4.12 Command Summary . . . . .                                 | 35 |
| 4.5 Programming Example . . . . .                                | 36 |
| 5. Test Usage Guidelines . . . . .                               | 39 |
| 5.1 General Rules . . . . .                                      | 39 |
| 5.1.1 Interpretation of Results . . . . .                        | 39 |
| 5.1.2 Probe/Sensor Interface . . . . .                           | 40 |
| 5.2 Diagnosing Sensor Faults . . . . .                           | 48 |
| 5.3 Cross-Manufacturer Compatibility . . . . .                   | 49 |

**OXITEST PLUS 7 OPERATING MANUAL**

|                                 |    |
|---------------------------------|----|
| 6. Routine Maintenance. . . . . | 51 |
| 6.1 Probe Cleaning. . . . .     | 51 |
| 6.2 Calibration. . . . .        | 52 |

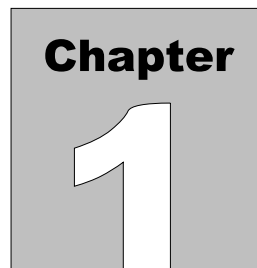

# 1. Specifications

## 1.1 Saturation ( $SpO_2$ )

Masimo, Nellcor, and Nellcor OEM's (e.g., Critikon; Protocol Systems; Philips; etc.):

Variable from 55% to 100% in steps of 1%  
 $SpO_2$  presets at 55, 70, 80, 90, 93, and 97%

All other supported oximeters:

Variable from 70% to 100% in steps of 1%  
 $SpO_2$  presets at 70, 80, 90, 93, and 97%

## 1.2 $SpO_2$ Accuracy

All supported oximeters except Datex and Invivo oximeters:

$\pm 1\%$  at specified  $SpO_2$  presets

Datex and Invivo oximeters:

$\pm 1\%$  at 97, 93%  $SpO_2$   
 $\pm 2\%$  at 90, 80, 70%  $SpO_2$

Nellcor and Nellcor OEM's only:

$\pm 1\%$  at 55%  $SpO_2$

*Nellcor accuracy specified with either DS100A sensor, or with  $SpO_2$  calibration selected via Nellcor Port.*

### **1.3 Heart Rate**

Variable from 20 to 250 beats per minute (BPM) in 1 BPM steps

*Presets:* 30, 60, 90, 120, 180, 240 BPM

*Accuracy:*  $\pm 1$  BPM

### **1.4 Pulse Amplitude**

Variable from zero (no blood flow) to 100% (normal adult pulse) in 1% steps.

*Presets:* 100%, 30%, 10%, and 5%

*Accuracy:*  $\pm 1\%$

### **1.5 Signal Artifact**

Four preset simulations:

Movement

Tapping (Spike artifact)

Shivering (Tremor artifact)

Shake Table (2.5Hz Sinewave)

### **1.6 Auto Presets**

Nine preset patient simulations.

Factory default Auto Presets:

Normal Adult

Hypoxia

Tachycardia

Bradycardia

Low Perfusion

No Perfusion

Movement Artifact

Neonate

Tremor (Shivering Artifact)

Auto Preset parameters may be user-programmed via the RS-232 port.

## **1.7 Alarm Tests**

Five automated test sequences for determining oximeter alarm response time to Low SpO<sub>2</sub>; Low Heart Rate; High Heart Rate; Low Perfusion; and Motion Artifact conditions. Also determines time required for oximeter alarm to self-clear after test conditions are returned to normal.

Alarm Test parameters may be user-programmed via the RS-232 port.

## **1.8 Memory**

Auto Preset and Alarm Test results saved in battery-backed, non-volatile Memory, along with up to 20 PASS/FAIL records from manually-conducted tests. Test results in Memory may be printed as a Test Report via optional external Printer, or may be downloaded via RS-232 port to personal computer or automated tester.

## **1.9 Pulse Oximeter Make / Model**

Major makes and models supported. Refer to the **Oxitest Plus 7** product CD, or [www.datrend.com](http://www.datrend.com), for a detailed listing.

## **1.10 User Interface**

Display:

LCD - 20 character x 2 line

Keypad - 15 keys:

PULSE OX, SPO<sub>2</sub> (%), HEART RATE (preset), HR▲, HR▼, PULSE AMP (preset), PUL▲, PUL▼, PASS, FAIL, AUTO (preset), ALARM TEST, START/STOP (alarm test), ERASE (memory), PRINT

## **1.11 Nellcor Port**

Allows temporary connection of Nellcor pulse oximeter sensors for selection of sensor-specific SpO<sub>2</sub> calibration curve. Intended for high-accuracy testing of all Nellcor disposable and re-usable sensors.

### **1.12 Serial / Printer Interface**

Mechanical: 5 Pin Mini-DIN  
Electrical: Bi-directional RS-232. 9600 baud, 8 bits, no parity, 1 stop.

### **1.13 Power Supply**

Battery: 7.2V rechargeable.  
Capacity: 1.4 Ah  
Battery life: 40 hours continuous

### **1.14 Environment**

15°C to 40°C, 10% to 90% RH  
Indoor Use Only  
Category II  
Pollution Degree 2  
Altitude 2000m (max)

Note: Mains supply voltage fluctuations not to exceed +/- 10% of the nominal supply voltage.

### **1.15 Standard Accessories**

AC Adapter (all models): 100-240 VAC 50/60 Hz to 12 VDC adaptor; P/N: 3000-025

And one of the Blade Sets for P/N 3000-025:

North America: P/N: 3000-401  
Europe: P/N: 3000-402  
United Kingdom: P/N: 3000-403  
Australia: P/N: 3000-404

### **1.16 Optional Accessories**

For a complete list of available accessories, visit [www.datrend.com](http://www.datrend.com) or contact Datrend Customer Service (see section 6.2 for contact details)

## 2. Overview

### 2.1 General Description

The **Oxitest Plus 7** Pulse Oximeter Tester is a portable, battery operated device designed to test the operation of pulse oximeters and their optical sensors. In use, a pulse oximeter sensor is placed on the **Oxitest Plus 7** probe. **Oxitest Plus 7** transmits an optical signal to the pulse oximeter sensor which simulates a predetermined oxygen saturation ( $SpO_2$ ) level, at a given heart rate and signal strength (pulse amplitude). Proper operation of the pulse oximeter is confirmed if the parameters measured by the oximeter match those generated by **Oxitest Plus 7**.

**Oxitest Plus 7** provides four simulations of patient motion artifacts: gross body movement, tapping the oximeter sensor, shivering or trembling, and shake table laboratory test. **Oxitest Plus 7** also provides 9 preset simulations to test oximeters under realistic clinical conditions, and five automated oximeter alarm tests. High accuracy testing of Nellcor sensors is available through the use of Nellcor's sensor specific calibration curves. Auto Preset, Alarm and manual test results may be output to a printer, or downloaded to a PC or automated tester for easy documentation.

Most problems with pulse oximeters can be traced to complete or partial failure of the oximeter sensor (the photo sensor, one of the two light transmitting elements [LEDs], the cable, or the connector). **Oxitest Plus 7** will assist in diagnosing sensor failures by providing an indication of the status of the oximeter's LEDs.

For comprehensive testing of sensors when no pulse oximeter is available, Datrend provides a companion test instrument: Sensitest.

## **2.2 Detailed Description**

Pulse oximeters commonly utilized in hospitals are based on the principle of the absorption of light by blood, at two separate wavelengths, 660 nm and 940 nm. Specifically, the relationship between the absorption of light for Oxygenated Haemoglobin (HbO<sub>2</sub>) and reduced Haemoglobin (Hb) allows the calculation of HbO<sub>2</sub>, and subsequently oxygen saturation.

A typical pulse oximeter probe incorporates one 660 nm light emitting diode (LED) and one 940 nm LED on the transmitting side of the sensor, and one broad spectrum photosensitive element on the receiving side of the sensor. The pulse oximeter activates the LEDs in a particular sequence which allows the received signals to be correctly interpreted. The light passes through a portion of the body of the patient, commonly the finger, ear, toe, scalp, etc., and falls on the photosensitive element, which translates the attenuated light signals into electrical signals.

Using various means, the pulse oximeters interpret the *ratio* of the attenuated signals at the two wavelengths as a percentage of oxygen saturation. A more detailed description of the process, and the scientific principles of pulse oximetry can be found in the article “Knowing Your Pulse Oximetry Monitors”, S. Ackerman and P. Weith, Medical Electronics, February, 1995, pp 82-86.

A block diagram of the **Oxitest Plus 7** is provided in *Figure 1*. The **Oxitest Plus 7** incorporates a probe, resembling a finger, which is placed between the transmitting and receiving elements of the oximeter. The **Oxitest Plus 7** probe intercepts the light signals produced by the pulse oximeter and generates pulses of light that are controlled in level, and which simulate the light levels which would normally be received by the pulse oximeter’s photosensitive element, at predetermined oxygen saturation levels.

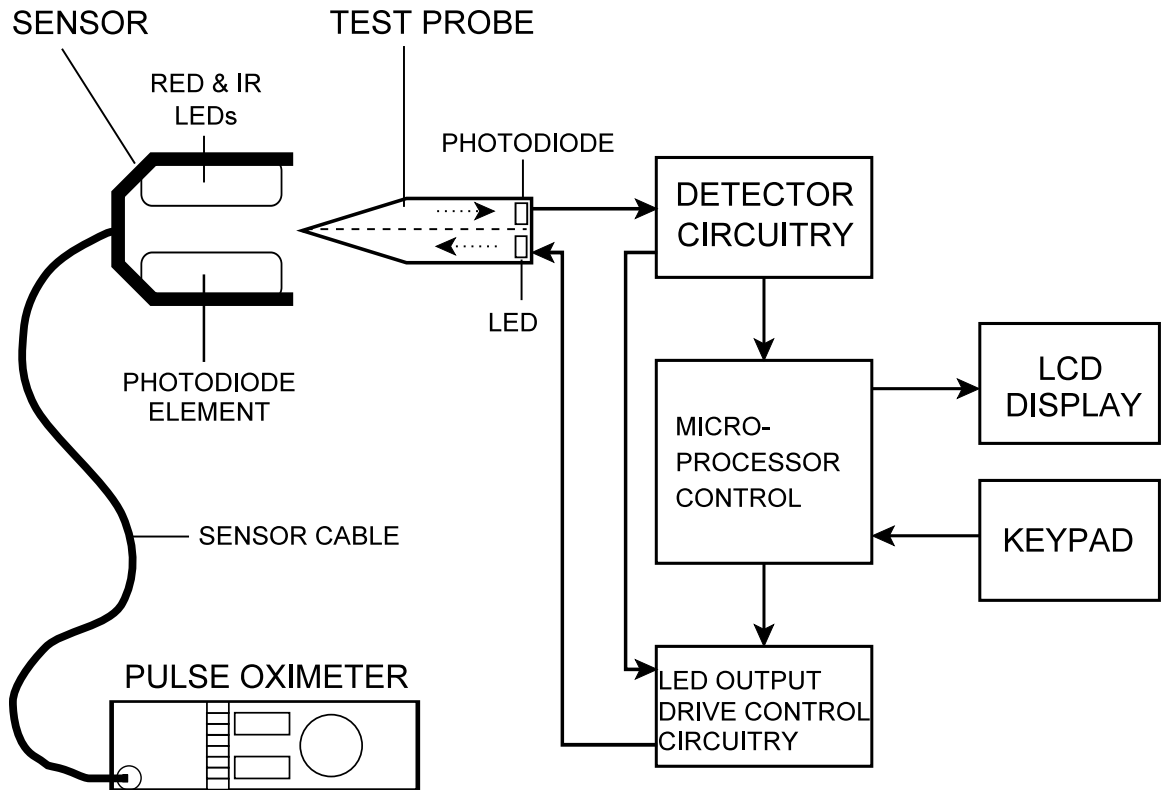

*Figure 1 - Block Diagram*

A photodiode in the **Oxitest Plus 7** probe intercepts the oximeter's red and infrared light signals, and generates an electrical signal which is analysed by the **Oxitest Plus 7** microprocessor. The microprocessor, in turn, produces control signals to drive an LED in the **Oxitest Plus 7** probe, with the correct timing and amplitude appropriate to the oximeter under test. Light from the **Oxitest Plus 7** LED is detected by the photodiode in the oximeter sensor, causing the oximeter to display simulated SpO<sub>2</sub> and heart rate indications.



## 3. Operation

### 3.1 General Description

The **Oxitest Plus 7** provides a quick and efficient method of testing the overall operation of a pulse oximeter, its cable and sensor. A test is performed by applying the oximeter sensor to the **Oxitest Plus 7** probe, after first setting up the test parameters on **Oxitest Plus 7**. The features of **Oxitest Plus 7** are depicted in *Figure 2* and *Figure 3*, and are referred to throughout the rest of section 3.

The following procedure should be followed for correct operation:

1. Turn the **Oxitest Plus 7 ON** by rotating the test probe 90 degrees from its protective storage compartment.
2. Following power-up, select an oximeter make (**Pulse Ox**) from the menu. Set the **SpO<sub>2</sub>**, **Heart Rate** and **Pulse Amp** to the desired settings using the appropriately labelled push button keys on the front panel. See sections 3.2 through 3.7 for further details. Default values for **SpO<sub>2</sub>**, **Heart Rate** and **Pulse Amp** on selection of a new oximeter are 97%, 60 BPM and 100% respectively.
3. Turn on the oximeter and examine the sensor to determine which side has the LEDs (this side will radiate red light). Apply the sensor to the test probe, orienting the sensor *with the LEDs on the underside of the probe*.
4. Wait for the **Oxitest Plus 7** to display "RED+IR OK!" on its LCD.
5. Change **Oxitest Plus 7 SpO<sub>2</sub>** and **Heart Rate** and note the oximeter's response. Verify the oximeter alarms when SpO<sub>2</sub> and/or heart rate exceed corresponding alarm thresholds. Optionally, decrease the Pulse Amp and note how the oximeter's SpO<sub>2</sub> and heart rate may be affected by low tissue perfusion.
6. Remove the oximeter sensor from the test probe.
7. Select a new oximeter (if required) and go back to step (3), or turn **Oxitest Plus 7 OFF** by rotating the test probe back into the storage compartment.

**OXITEST PLUS 7 OPERATING MANUAL**



*Figure 2 - Oxitest Plus 7 Side Panel*



*Figure 3 - Oxitest Plus 7 Front Panel*

### **3.2 Powering Up, and Modifying the Oxitest Plus 7 Menu**

To turn on the **Oxitest Plus 7** rotate the test probe, which is visible from the right hand side of the **Oxitest Plus 7**, 90 degrees clockwise from its storage compartment. **Oxitest Plus 7** will go through a power-on self-test (POST). The LCD display will appear as shown below.

```
**Oxitest PLUS 7**  
***Version: X.X***
```

After the POST is completed, the display will show the current test parameters as follows.

```
N-200      NO SIGNAL  
97%      60 BPM      100%
```

When initially delivered, the default test parameters are set to Nellcor N-200, 97% SpO<sub>2</sub>, 60 BPM and 100% pulse amplitude. If the parameters are changed, the **Oxitest Plus 7** will retain the settings in memory and power up with those parameters on next use.

When received from the factory, all pulse oximeters with which **Oxitest Plus 7** is compatible will be **ENABLED** in the **Pulse Ox** menu list. Not all oximeters will be pertinent to every user. To reduce the number of oximeters presented in the menu list, individual oximeters can be **DISABLED** with the *Setup Function* described below.

To enter the *Setup Function*, depress the SpO<sub>2</sub> button while turning on the power to the **Oxitest Plus 7**. The display shown below will appear for about 2 seconds.

```
**PULSE OX SETUP**  
***Version: X.X***
```

The pulse oximeter information will then be displayed as shown below. The oximeter information includes the manufacturer name, model number(s) and the type of sensor used (manufacturers may use more than one type of sensor, each of which may require a different SpO<sub>2</sub> curve, or “R-Curve”).

```
Nellcor N-200,N-100C  
SENSOR: Nellcor >ENA
```

## OXITEST PLUS 7 OPERATING MANUAL

The menu of oximeters provides up to 128 entries. The **Pulse Amp ▲** or **▼** keys will single-step through the menu sequentially, moving up or down respectively. To move more rapidly through the different menu selections, the **Heart Rate ▲** or **▼** keys will move in steps of *two* entries at a time.

The previous display indicates if the oximeter is currently **EN**abled or **DIS**abled. Press the **Pulse Ox** key to toggle the **EN**abled or **DIS**abled status of the displayed oximeter.

When only the relevant oximeters are **EN**abled, press the **SpO<sub>2</sub>** key, and **Oxitest Plus 7** will revert to normal operation. The only oximeters that will now be available for selection in the menu of **Pulse Ox**'s will be those that have been **EN**abled. This process may be repeated at any time to **EN**able or **DIS**able other oximeters.

In the event of a loss of battery power, **Oxitest Plus 7** will revert to the *factory default settings* (all oximeters **EN**abled; Pulse Ox = Nellcor N-200; SpO<sub>2</sub> = 97%; Heart Rate = 60 BPM; Pulse Amp = 100%).

If it is desirable to reset **Oxitest Plus 7** to the factory default settings for any reason, hold down the **Heart Rate** preset key while powering up the unit. The display will appear as shown below. In response to the LCD prompt, the factory defaults are loaded by pressing the **YES** (Pass) key or the **No** (Fail) key.

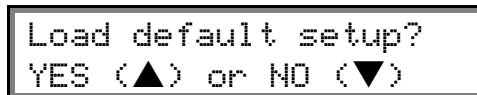

Load default setup?  
YES (▲) or NO (▼)

### 3.3 Setting Display Contrast

Display contrast for **Oxitest Plus 7** is pre-set at the factory. Should it become necessary to adjust the display contrast, the adjustment control is located in the probe storage compartment (refer to *Figure 4*). **Oxitest Plus 7** must be powered ON (finger probe extended) in order to access this adjustment.



Figure 4

### 3.4 Choosing an Oximeter

The oximeter currently selected is displayed on the standard operating mode screen, as shown below.

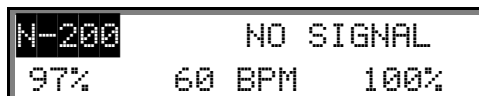

To change oximeters, press the **Pulse Ox** key. The current oximeter/sensor selection appearing in the previous display will then be displayed in full detail across the LCD as follows.

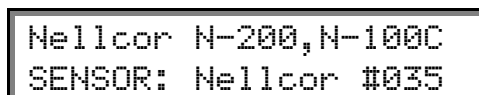

To scroll through the oximeters (which have been **EN**abled through the process described in section 3.2), press the **Pulse Ox** key repeatedly to move forward through the available oximeters, one step at a time, until the oximeter of interest is displayed. Alternately, the **Pulse Amp ▲** or **▼** keys will single step through the menu, moving up or down respectively, and the **Heart Rate ▲** or **▼** keys will move in steps of *two* entries at a time. Either **▲** (or **▼**) key may be pressed and held to continuously scroll forward (or backward) through the menu. To finalize the selection, press the **SpO<sub>2</sub>** key, and **Oxitest Plus 7** will return to the standard operating screen.

*Note:* Only those oximeters that have been **EN**abled as in section 3.2 will be available for selection. Repeat the setup process at any time to enable or disable oximeters in the menu list.

**Oxitest Plus 7** will display the make of the oximeter *sensor* used with the device under test on the lower line of the LCD. This is because some pulse oximeters can be used with more than one make of sensor (many oximeters are compatible with Nellcor as well as their own brand of sensor). When selecting the oximeter, be sure to choose the correct *sensor* as well as the appropriate make and model, as sensors from different manufacturers may have different SpO<sub>2</sub> calibration curves (R-Curve).

Oximeters manufactured by BCI International and Nonin are operable with sensors made by another leading pulse oximeter manufacturer. These cross-combinations of oximeter and sensor make are identified in the **Oxitest Plus 7** menu by the "SENSOR: Non-OEM" designation. As it is common practice to use BCI and Nonin oximeters with the other oximeter manufacturer's sensor, the **Oxitest Plus 7** provides for testing this combination. It should be noted, however, that BCI, Nonin, and the other leading oximeter manufacturers do not recommend use of their respective products in such combination.

### **3.5 Selecting an SpO<sub>2</sub> level**

**Oxitest Plus 7** simulates five (5) preset levels of oxygen saturation - 97, 93, 90, 80 and 70%. An additional preset level of 55% is available when testing Nellcor and Nellcor OEM oximeters, such as Critikon, MDE, Mennen and Protocol Systems, as well as when testing oximeters that use Nellcor sensors under license, such as HP, Philips, Marquette, Siemens and SpaceLabs.

The **SpO<sub>2</sub>** preset is changed by pressing the **SpO<sub>2</sub>** key on the front panel. The selected **SpO<sub>2</sub>** preset will be indicated on the standard operating screen at the lower left corner of the display, as follows.

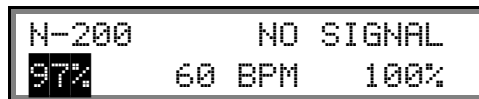

The **SpO<sub>2</sub>** preset on power up will be the one retained from the last test performed.

The oxygen saturation simulation can be fine-tuned in steps of 1% by means of the "ADJUST SPO2" menu. To access this menu, press the **SpO<sub>2</sub>** and **Pulse Ox** keys simultaneously. The display will then change to the following:



Use the ▲ and ▼ keys associated with the **Heart Rate** key or the **Pulse Amp** key to adjust the oxygen saturation as desired. Continuous adjustment is possible in 1% steps from 100% down to the lowest SpO<sub>2</sub> preset provided, which may be either 70% or 55% depending on the oximeter as described above. To exit the "ADJUST SPO2" menu and return to the standard operating screen, press either the **SpO<sub>2</sub>** key or the **Pulse Ox** key.

### 3.6 Selecting a Heart Rate

**Oxitest Plus 7** provides a pulse repetition rate of 20 to 250 beats per minute (bpm), with six preset values of 30, 60, 90, 120, 180 and 240 bpm. To select a new preset value, press the key labelled **Heart Rate** on the front panel. The **Heart Rate** indicator, in the middle of the second line of the LCD screen, will change to indicate the selected rate, as shown.



For values between the preset rates, use the ▲ and ▼ keys associated with the **Heart Rate** key. The **Heart Rate** can be changed in increments of 1 bpm over the full range of 20 - 250 bpm. The ▲ and ▼ keys may be held down to change the rate continuously.

The **Heart Rate** value on power up will be the one retained from the last test performed.

### 3.7 Selecting a Pulse Amplitude

**Oxitest Plus 7** provides pulse amplitude settings from 0 to 100 percent, with four preset values of 100, 30, 10 and 5%. The pulse amplitude control provides a means of simulating various levels of tissue perfusion or peripheral pulse "strengths". An **Oxitest Plus 7** pulse amplitude of 100% corresponds to a normal adult pulse in the index finger. A pulse amplitude of 5% simulates poor distal circulation or a very weak peripheral pulse, and a pulse amplitude of zero simulates no distal blood flow.

To select a new preset value, press the key labelled **Pulse Amp** on the front panel. The **Pulse Amplitude** indicator, at the lower right of the LCD screen, will change to indicate the selected percentage value, as shown below.

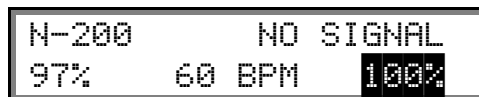

For values between the preset amplitudes, use the ▲ and ▼ keys associated with the **Pulse Amp** key. The **Pulse Amplitude** can be changed in increments of 1% over the full range of 0-100 %. The ▲ and ▼ keys may be held down to change the pulse amplitude continuously.

The **Pulse Amplitude** value on power up will be the one retained from the last test performed.

### **3.8 Status Indicator**

The STATUS indicator, in the upper right corner of the standard operating screen, as shown below, provides user feedback on the test in progress.



The following STATUS messages may be displayed:

- NO SIGNAL** No optical signal is currently being received by **Oxitest Plus 7** from the oximeter under test. Possibly the oximeter sensor has not been applied to the **Oxitest Plus 7** probe.
- Testing...** **Oxitest Plus 7** has detected an optical signal and is testing the signal to see if it is consistent with the selected oximeter.
- NO RED** An optical signal has been detected, but there is no signal which corresponds to the output of the RED LED. Probable sensor or cable failure.
- NO IR** An optical signal has been detected, but there is no signal which corresponds to the output of the infrared (IR) LED. Probable sensor or cable failure.
- RED+IR OK** The optical signal detected by **Oxitest Plus 7** is consistent with the oximeter selected and **Oxitest Plus 7** is outputting a simulated signal to the oximeter.
- INV.SENSOR** **Oxitest Plus 7** has detected an external optical signal on the upper probe surface, indicating that the oximeter sensor has probably been applied upside down. Remove and replace the sensor with the sensor LEDs on the *lower* surface of the **Oxitest Plus 7** probe .

If the **STATUS** message enters the **Testing...** phase and then begins to rapidly change, it is probable that the oximeter under test is not the same make and model as the oximeter selected in **Oxitest Plus 7**. Change the **Oxitest Plus 7 Pulse Ox** selection to match the oximeter and retry the test.

When testing some oximeters, **Oxitest Plus 7** may not, at first, correctly recognize the red and IR light flashes produced by the oximeter. In this case, **Oxitest Plus 7** status display will show RED+IR OK but the oximeter saturation reading will significantly disagree with the **Oxitest Plus 7** SpO<sub>2</sub> setting. The simplest solution is to remove the oximeter sensor from the **Oxitest Plus 7** probe, wait a few seconds, and then re-apply the sensor to **Oxitest Plus 7**. Alternatively, the

oximeter can be powered up *after* applying the sensor to **Oxitest Plus 7**. Positioning the sensor properly may be more difficult for short, stubby sensors. Section 5.1.2 offers some advice on how to position some specific types of sensors.

### **3.9 Selecting Motion Artifact Simulation**

**Oxitest Plus 7** provides four waveforms for simulating various motion artifact conditions. The *MV wave* adds low frequency noise to the normal patient signal, simulating slow, whole-body movements. The *SP wave* adds sharp noise spikes to the patient signal, simulating the oximeter sensor being struck or tapped at random times. The *TR wave* simulates patient tremor or shivering. The *Sn wave* is a high-amplitude 2.5 Hertz sinewave interference, simulating a "shake table" laboratory test of a pulse oximeter, as described by Barker et al in "The effects of motion on the performance of pulse oximeters in volunteers", *Anesthesiology*, 1997; 86:101-8.

The motion artifact simulation is activated by pressing the **Heart Rate** and **Pulse Amp** keys simultaneously. In response to this key combination, the **Oxitest Plus 7** will emit a double-beep and activate the MV wave, as indicated by the "M<sub>V</sub>" characters displayed to the left of the pulse amplitude on the LCD:

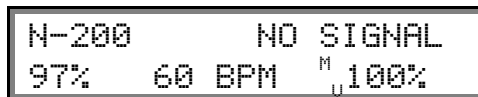

In manual mode, successive presses of **Heart Rate** with **Pulse Amp** will activate the SP, TR and Sn waves in turn, indicated on the display as "S<sub>P</sub>", "T<sub>R</sub>", and "S<sub>n</sub>" as for the MV wave above. A fifth press of **Heart Rate** with **Pulse Amp** will de-activate the motion artifact simulation.

In Auto Preset mode, two of the nine factory default presets include motion artifact simulations. The Alarm Test Mode also provides one alarm test in which the MV wave is turned on and then off by the **Start/Stop** key. This allows measurement of the oximeter's alarm response to motion artifacts.

In manual mode, SpO<sub>2</sub>, heart rate, and pulse amplitude settings on **Oxitest Plus 7** may be independently varied while the motion artifact simulation is active.

Stability and accuracy of a pulse oximeter under motion artifact conditions is highly dependent on the *noise-to-signal ratio* (NSR), that is, the relative strength of the artifact signal to the uncorrupted patient signal. When motion artifact is activated on **Oxitest Plus 7**, simulated NSR may be continuously varied by means of the Pulse Amp controls. For example, with the pulse amplitude set to 20%, the NSR would be 5:1.

### **3.10 Selecting Auto Presets**

The Auto Preset selections are selectable by pressing the **Auto** key on the front panel until the desired preset selection appears. Each Auto Preset specifies the SpO<sub>2</sub> level, heart rate, pulse amplitude and signal artifact settings as a group. The nine default Auto Preset selections are listed in the table below. These selections may be programmed to alternative values via the RS-232 port, using the *OxiEdit* software which is available at [www.datrend.com](http://www.datrend.com).

| Auto # | SpO <sub>2</sub> | Heart Rate | Pulse Amp | Artifact | Title         |
|--------|------------------|------------|-----------|----------|---------------|
| 1      | 97%              | 72bpm      | 100%      | Off      | Normal Adult  |
| 2      | 80%              | 95bpm      | 100%      | Off      | Hypoxia       |
| 3      | 97%              | 157bpm     | 100%      | Off      | Tachycardia   |
| 4      | 97%              | 38bpm      | 100%      | Off      | Bradycardia   |
| 5      | 97%              | 66bpm      | 4%        | Off      | Low Perfusion |
| 6      | 97%              | 60bpm      | 0%        | Off      | No Perfusion  |
| 7      | 93%              | 145bpm     | 40%       | Off      | Neonate       |
| 8      | 97%              | 70bpm      | 33%       | Movement | Movement      |
| 9      | 97%              | 89bpm      | 52%       | Tremor   | Shivering     |

The factory default Auto Preset settings can be reloaded by powering up the unit while pressing the **Auto** key. In response to the displayed LCD prompt press the **Yes** (Pass) key to reload the default Auto parameters shown in the table above, or **No** (Fail) to abort the reload.

### **3.11 Selecting Alarm Tests**

The Alarm Test Mode provides the capability of performing autosequenced tests of the alarm functions on a pulse oximeter. Five different kinds of Alarm Tests are provided: low saturation, high pulse rate, low pulse rate, low signal level and motion artifact.

The Alarm Test Mode works by switching **Oxitest Plus 7** from a "normal patient" simulation to an "abnormal patient" simulation, and allowing the user to measure the time the oximeter takes to produce an audio-visual alarm. After the user records the time of the oximeter alarm, the tester is reset back to the normal patient simulation, and the user then records time required for the oximeter to shut off the alarm. The Alarm Test Mode therefore determines *both* the alarm "ON TIME", *and* also the length of time the alarm persists under normal patient conditions, the "OFF TIME".

## OXITEST PLUS 7 OPERATING MANUAL

Pressing the **Alarm Test** key produces the following LCD display:

```
LOW SAT ALM  T: 00.0  
97%      72 BPM  100%
```

As shown above, the LCD displays the name of the alarm test at the upper left, a timer counter at the upper right, and the test settings corresponding to the "normal patient" condition on the lower line.

By pressing the **Alarm Test** key, the user can select one of the four remaining alarm tests. In addition to the test above, the remaining tests appear as follows:

```
HI RATE ALM  T: 00.0  
97%      72 BPM  100%
```

```
LO RATE ALM  T: 00.0  
97%      72 BPM  100%
```

```
LOW SIG ALM  T: 00.0  
97%      72 BPM  100%
```

```
ARTFACT ALM  T: 00.0  
97%      72 BPM  100%
```

As long as the user refrains from pressing the **Start/Stop** key, **Oxitest Plus 7** continuously outputs the simulation corresponding to the parameters shown on the lower line of the LCD. Pressing the **Start/Stop** key immediately initiates the selected alarm test by switching the test parameters to the abnormal patient setting, and starts the timer counting in the top right corner of the LCD.

## OXITEST PLUS 7 OPERATING MANUAL

The effect of the **Start/Stop** key on the tester depends on the Alarm Test selected by the user, as follows:

Prior to pushing **Start/Stop**:

| <u>Alarm Test</u> | <u>SpO<sub>2</sub></u> | <u>Hrt. Rate</u> | <u>P. Amp</u> | <u>Artifact</u> |
|-------------------|------------------------|------------------|---------------|-----------------|
| All Tests         | 97%                    | 72 BPM           | 100%          | Off             |

Effect of pushing **Start/Stop**:

|      | <u>Alarm Test</u> | <u>SpO<sub>2</sub></u> | <u>Hrt. Rate</u> | <u>P. Amp</u> | <u>Artifact</u> |
|------|-------------------|------------------------|------------------|---------------|-----------------|
| #1 - | LOW SAT           | 70%                    | 72 BPM           | 100%          | Off             |
| #2 - | HI RATE           | 97%                    | 180 BPM          | 100%          | Off             |
| #3 - | LO RATE           | 97%                    | 40 BPM           | 100%          | Off             |
| #4 - | LOW SIG           | 97%                    | 72 BPM           | 3%            | Off             |
| #5 - | ARTIFACT          | 97%                    | 72 BPM           | 20%           | MV              |

For example, the LOW SAT alarm test operates as follows:

1. The user presses the **Alarm Test** key until the LOW SAT alarm test is shown on the LCD:

```
LOW SAT ALM T: 00.0
97%      72 BPM    100%
```

2. The user starts the LOW SAT test by pressing **Start/Stop**. The alarm test immediately switches the SpO<sub>2</sub> from 97% to 70%, and the timer at the top right of the LCD begins incrementing in 0.1 second steps:

```
LOW SAT ALM T: 00.1
70%      72 BPM    100%
```

3. When the oximeter under test produces an audio alarm, the user presses the **Start/Stop** key to stop the timer, and save the alarm ON TIME in the **Oxitest Plus 7** memory:

```
ALARM ON: 15.8 sec
Please wait...
```

## OXITEST PLUS 7 OPERATING MANUAL

4. To allow the oximeter under test to stabilize to the "abnormal patient" simulation, a delay of 5 seconds is introduced at this point, as shown above.
5. After this delay, the alarm test automatically resets the SpO<sub>2</sub> to the "normal patient" level (97%). The timer is automatically reset to zero at this point and begins counting up again:

```
LOW SAT ALM T: 00.1
97%      72 BPM   100%
```

6. When the oximeter alarm shuts off, the user presses **Start/Stop** for the third time. This stops the timer, and records the alarm OFF TIME in the **Oxitest Plus 7** memory. The LCD automatically displays the final test results as follows:

```
ALARM ON:  15.8 sec
ALARM OFF:  7.3 sec
```

Pressing any key except **Alarm Test** at this point will exit the Alarm Test Mode. Pressing **Alarm Test** with the LCD in the state shown above causes the display to return to the state shown in step (1.).

The HI RATE, LO RATE and LOW SIG tests operate in a similar manner to the above, except that the tester heart rate (HI/LO RATE), pulse amplitude (LOW SIG), or motion artifact (ARTFACT) is varied accordingly, with the remaining test parameters left constant.

The Alarm Test Mode exits to the Manual Mode if any key other than **Alarm Test** or **Start/Stop** is pressed. This will also abort an alarm test which is in progress. When exiting the Alarm Test Mode, the test parameters are set to default values of 97% SpO<sub>2</sub>, 60 BPM heart rate, and 100% pulse amplitude.

The parameters of the Alarm Test Mode may be programmed to alternative values via the RS-232 port, using the *OxiEdit* software which is available at [www.datrend.com](http://www.datrend.com).

The factory default Alarm Test parameters can be reloaded by powering up the unit while holding down the **Alarm Test** key. In response to the LCD prompt, press the **Yes** (Pass) key to reload the test default test settings, or **No** (Fail) to abort the reload.

### **3.12 Saving and Printing Test Results**

Up to 20 PASS/FAIL results from manually-conducted tests may be saved in the memory of **Oxitest Plus 7** for later printout or downloading to a personal computer (PC). In addition to the 20 manual test results, **Oxitest Plus 7** can also save the results of Auto Preset tests and Alarm Tests.

Manual test and Auto Preset test results are saved to **Oxitest Plus 7** memory by pressing either the **Pass** or **Fail** key on the front panel keypad. The information saved includes the test SpO<sub>2</sub>, heart rate, pulse amplitude and motion artifact settings, plus the PASS or FAIL status of the test and the oximeter signal status displayed at the upper right corner of the **Oxitest Plus 7** LCD. The oximeter signal status is saved in abbreviated format as follows: OK = “RED+IR OK”; NoRD = “No Red”; NoIR = “No IR”; and ?? = “NO SIGNAL” or “Testing”.

For each Alarm Test performed, the oximeter ALARM-ON and ALARM-OFF times are automatically saved in the **Oxitest Plus 7** memory if the Alarm Test is run through to completion. There is no need to press **Pass** or **Fail** to save the results of an Alarm Test.

All test results saved in the **Oxitest Plus 7** memory are retained by battery back-up when the power is switched off. This allows test results to be acquired over a period of time and then printed out or downloaded later.

Pressing the **Print** key causes the test results saved in the memory to be transmitted from the **Oxitest Plus 7** RS-232 Port as a formatted “Test Report”. The **Oxitest Plus 7** RS-232 Port may be connected to a Citizen iDP-3110 serial printer or to a personal computer. Refer to section 4.2 for the interconnection cable details.

The format of the Test Report is similar to the following example printout:

## OXITEST PLUS 7 OPERATING MANUAL

Oxitest PLUS 7 Pulse Oximeter Tester

PULSE OX TEST REPORT

Time/Date: \_\_\_\_\_

Control No.: \_\_\_\_\_

Serial No.: \_\_\_\_\_

Location: \_\_\_\_\_

Department: \_\_\_\_\_

Technician: \_\_\_\_\_

Oxitest settings:

PULSE OX: Nellcor N-200, N-100C

SENSOR: Nellcor W. SELECTED R-CURVE

```
-----Oxitest----- --Status--
Rec. SpO2 Rate Amp. Artf LEDs
1 97% 75BPM 100% Off OK PASS
2 93% 75BPM 100% Off OK PASS
3 90% 75BPM 100% Off OK PASS
4 97% 150BPM 30% Off OK PASS
5 97% 240BPM 15% MOVN NoRD FAIL
```

```
-----Oxitest----- --Status--
Auto SpO2 Rate Amp. Artf LEDs
1 97% 72BPM 100% Off OK PASS
4 97% 38BPM 100% Off OK PASS
6 97% 60BPM 0% Off NoIR FAIL
9 97% 89BPM 52% TREM OK PASS
```

```
ALARM TEST ON-TIME OFF-TIME
LOW SAT 9.8 sec 7.1 sec
HI RATE 10.6 sec 8.5 sec
LO RATE 17.4 sec 15.1 sec
LOW SIG 23.1 sec 7.4 sec
```

In the prior example, the results of five manual tests, four Auto Preset tests and four Alarm Tests were saved. As shown, the **Oxitest Plus 7** signal status appears under the “LEDs” column and the PASS or FAIL status of the test result appears at the far right. Manual test #5 shows that the oximeter’s red LED may have been defective, which was recorded as a “FAIL”. Similarly, Auto Preset test #6 was also recorded as a “FAIL” due to a potentially defective infrared LED in the oximeter sensor.

If the printer is not attached, or not on-line when the **Print** key is pressed, then the error message shown below will be displayed. The off-line condition is tested immediately after pressing the **Print** key and periodically while the printing is in progress.

```
***** ERROR *****
Printer is OFF-LINE!
```

The **Erase** key permits the erasure of the last test record saved (in case **PASS** or **FAIL** was pressed at the wrong time or under the wrong conditions) or the erasure of all test records. When the **Erase** key is pressed, the display as shown below, results.

```
ERASE last record?  
Press YES or NO...
```

Pressing the **Yes** key erases the last test record, while pressing the **No** key leaves the saved information unchanged. In both cases, the following display results.

```
ERASE all records?  
Press YES or NO...
```

All test records will be erased if the **Yes** key is pressed, or no records will be erased if the **No** key is pressed. After printing the Test Report, only the second display appears.

### **3.13 Using the Nellcor Sensor Port**

Inside every sensor manufactured by Nellcor (Tyco) is a unique resistor which is used by Nellcor-technology oximeters in selecting a particular SpO<sub>2</sub> calibration curve (R-Curve) to match the oxygen saturation characteristic of the sensor. The Nellcor Port located at the top of the **Oxitest Plus 7** enclosure (DB9 female) allows temporary connection of Nellcor sensors to the **Oxitest Plus 7**, so that the sensor's calibration resistor can be measured and the SpO<sub>2</sub> calibration curve corresponding to the resistor selected. Use of the Nellcor Port thus facilitates high-accuracy testing of both disposable and re-usable Nellcor sensors, with an accuracy of +/-1% across the entire range of simulated SpO<sub>2</sub> levels (55 - 97%).

At power-up reset, or when a Nellcor or Nellcor OEM pulse oximeter is selected from the **Oxitest Plus 7** Pulse Ox menu, the default Nellcor "R-Curve" is selected. After selecting the Nellcor N-200, for example, the Manual Mode display would appear as follows on the LCD:

```
N-200      NO SIGNAL  
97%      60 BPM      100%
```

As long as the STATUS display remains in the **NO SIGNAL** state, the Nellcor port is sampled by **Oxitest Plus 7**.

To use the Nellcor Port, perform the following steps:

## OXITEST PLUS 7 OPERATING MANUAL

1. Select a Nellcor compatible pulse oximeter from the menu.
2. Disconnect the sensor from the pulse oximeter and connect it to the Nellcor Port DB9 connector at the top of **Oxitest Plus 7**.
3. **Oxitest Plus 7** will measure the resistance in the Nellcor compatible sensor. If the resistance is acceptable, a "sensor-detect beep" is produced and the following message is displayed on the LCD for as long as the sensor remains connected to the Nellcor Port:

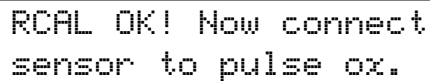

```
RCAL OK! Now connect
sensor to pulse ox.
```

4. Disconnect the sensor from the Oxitest Plus 7's Nellcor Port and reconnected to the oximeter. The display returns to the Manual Mode, with the alternate "R-Curve" being indicated by a "R" on the LCD as shown below:



```
N-200  R NO SIGNAL
97%    60 BPM    100%
```

5. Apply the sensor to the **Oxitest Plus 7** probe and commence testing .

If the detected resistance lies outside the acceptance range for Nellcor sensors, an "error beep" is produced and the following error message is displayed as long as the sensor remains connected to the Nellcor port:

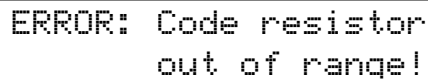

```
ERROR: Code resistor
out of range!
```

In this case, the default Nellcor "R-Curve" will be selected when the sensor is removed from the Nellcor Port.

An "error beep" is produced in response to the following error conditions:

- detection of a resistance at the Nellcor Port when the pulse oximeter selected from the menu is not compatible with Nellcor sensors; or

## OXITEST PLUS 7 OPERATING MANUAL

- detection of a resistance at the Nellcor Port when a Nellcor-compatible oximeter selected from the menu does not make use of the Nellcor "R-Curves"; or
- the signal STATUS is something other than "NO SIGNAL"

For any of the above conditions, the following message is displayed for as long as the sensor remains connected to the Nellcor Port:

```
ERROR:Sensor R-Curve  
selection disallowed
```

The Nellcor Port is also sampled in Auto and Alarm Test modes, and the same rules apply for allowable selection of the Nellcor "R-Curve" as with Manual Mode. However, as the pulse oximeter name is not displayed on the LCD in Auto and Alarm Test modes, no indication is given that an alternate "R-Curve" is currently in use. Note that the LCD will still display the process of selecting the curve (via the "RCAL OK!" messages, etc.).

### 3.14 ECG Trigger Output

Some pulse oximeters provide an input for a high level ECG signal, such as may be output by a patient monitor. Such oximeters use the QRS complex of the ECG to synchronize and validate data acquisition from the oximeter sensor, thereby improving signal-to-noise ratio under conditions of low perfusion or motion artifact. On Nellcor oximeters (e.g. models N-200 and up), this feature is called "C-LOCK".

**Oxitest Plus 7** provides an ECG Trigger output signal which may be used to test the Nellcor C-LOCK function and similar capabilities on other oximeters (e.g. Nonin 8800). The ECG TRIGGER signal is not a simulated ECG waveform, but simply a logic pulse of width and timing comparable to the QRS, which is appropriate for triggering the pulse oximeter.

The ECG TRIGGER pulse is output from a 3.5 mm miniature mono phono jack located on the right panel as indicated in *Figure 2*. The sleeve is grounded, and the tip is the trigger signal.

The **Oxitest Plus 7** ECG TRIGGER output is intended to drive high impedance loads, and will deliver 2.5 volts into a 10K ohm load. This is optimal for driving the Nellcor N-200 via the ECG IN/OUT interface, a 2.5 mm sub-miniature mono phono jack located on the rear panel of the oximeter.

Refer to the manufacturer's Service Manual for the pulse oximeter when interfacing the ECG input of the unit under test to the **Oxitest Plus 7** ECG TRIGGER output.

### **3.15 Recharging the Battery**

**Oxitest Plus 7** is powered by an internal NiCad battery with sufficient capacity to provide approximately 40 hours of operation. When the **Oxitest Plus 7** is OFF, the battery powers a non-volatile memory which retains the test settings, the **EN**Able/**DIS**able status of the pulse oximeter menu, and any **Pass/Fail** test results which may have been saved in memory. Power drain from the battery in this case is negligible.

When the battery approaches full discharge, the STATUS display as shown in Section 3.8 Status Indicator, will alternate with a **LO BATTERY** indication. To recharge the battery, plug the supplied AC adapter into a wall outlet and the **Oxitest Plus 7** DC ADAPTOR input (see *Figure 2*). *Use only the adaptor supplied with the Oxitest Plus 7 to recharge the battery.* A full battery recharge will require approximately 14 hours.

If the **Oxitest Plus 7** battery reaches full discharge during use, the unit will stop operating and the message shown below will appear on the display. In this case, the **Oxitest Plus 7** should be powered down and the battery given a full recharge as soon as possible.

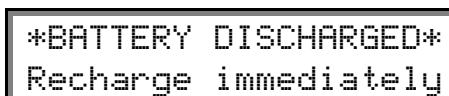

\*BATTERY DISCHARGED\*  
Recharge immediately

If the **Oxitest Plus 7** battery is near deep-discharge at power-up, the LCD will remain blank and the **Low Battery** alarm LED on the front panel will illuminate (see *Figure 3*). The **Oxitest Plus 7** will not be operable in this case and should be powered down and the battery given a full recharge prior to further use. A battery discharged to this level may require replacement or reconditioning to ensure optimal portable operation of the unit.

**Oxitest Plus 7** may also be powered with the supplied switch-mode AC adapter. Having the **Oxitest Plus 7** powered up will have no effect on the amount of time required to recharge the battery.

*Note:* Older **Oxitest Plus 7** units were supplied with linear AC adapters (refer to Section 1.15 for replacement part numbers and serial number effectivity). For older model **Oxitest Plus 7** units, recharging the battery while powered up requires somewhat more time than with the unit powered down.

Unless portable operation is not required, it is not recommended that **Oxitest Plus 7** be connected to the AC Adapter continuously as this may reduce the life of the battery. The battery will maintain its capacity longer if **Oxitest Plus 7** is routinely run until LO BATTERY is indicated on the STATUS display and then fully recharged. All NiCad batteries, however, will degrade over time.

## OXITEST PLUS 7 OPERATING MANUAL

Newer **Oxitest Plus 7** units feature battery monitoring and protection circuitry. In the event the **Oxitest Plus 7** battery becomes deeply discharged, the protection circuit will disconnect the battery internally when the battery voltage falls below a set threshold voltage. This typically occurs when a unit with an older battery is left on the shelf for a prolonged period of time.

### *Notes:*

- If the battery is discharged to the point where the protection circuitry activates, reconditioning of the battery may be indicated if an overnight charge does not restore the battery to full capacity.
- Once the protection circuitry has internally disconnected the battery, **Oxitest Plus 7** will not power up by turning the finger probe. To reset the unit, the switch-mode AC adapter must be plugged into the AC mains and connected to **Oxitest Plus 7**. This can be done with the **Oxitest Plus 7** ON or OFF. Once reset, **Oxitest Plus 7** can be used with the AC adapter, or without the AC adapter, once the battery has been fully charged.
- When the protection circuitry disconnects the battery, all saved data and settings will be lost.

The **Oxitest Plus 7** battery can be removed for replacement or reconditioning through the battery compartment access door on the underside of the unit.

### *Notes:*

- Once the battery has been physically disconnected from the unit, **Oxitest Plus 7** will not power up by turning the finger probe. To reset the unit, the switch-mode AC adapter must be plugged in to the AC mains and connected to **Oxitest Plus 7**. This can be done with the **Oxitest Plus 7** ON or OFF.
- When the battery is physically disconnected from the unit, all saved data and settings will be lost.

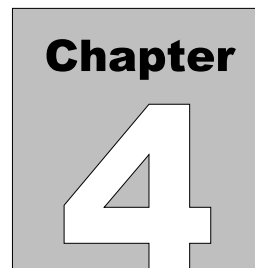

## 4. Computer Control and RS-232

The operating parameters of **Oxitest Plus 7** can be controlled by an external device, through an RS-232 serial communications port. This allows **Oxitest Plus 7** to be interfaced to an automated tester or PC for automated oximeter testing. It also allows the control of the test parameters, data transfer, and remote editing of Oximeter Menu, Auto Preset and Alarm Test settings.

**Oxitest Plus 7** may be operated via the front panel keypad while simultaneously responding to commands via the RS-232 port. The five control commands (Select Oximeter; Set SpO<sub>2</sub>; Set Heart Rate; Set Pulse Amplitude, and Activate Artifact Simulation), and three of the download commands (Download Manual, Auto Preset and Alarm Test Record) are all compatible with most automated safety analyzers.

### **4.1 Electrical Interface**

RS-232, Bidirectional, 9600 baud, 8 bits, No parity, 1 stop bit.

Maximum cable length restricted to 10 feet.

## **4.2 Mechanical Interface**

The **Oxitest Plus 7** RS-232 port located on the right side of the unit is a 5-pin mini-DIN female connector. The R-103 DB9 RS-232 accessory cable (P/N 7100-248) is available to connect to the 5-pin mini-DIN female connector.

A cable made to the specifications in the table following may be used to connect **Oxitest Plus 7** to the COM port of a PC or medTester. **Oxitest Plus 7** mates with the 5-pin miniDIN male connector, and the PC or medTester mates with the DB-9 female connector.

| (Oxitest)<br>5-pin miniDIN | to | (medTester/PC)<br>DB-25 female | to | DB-9 female |
|----------------------------|----|--------------------------------|----|-------------|
| pin 5 (TXD)                | to | pin 3 (RXD)                    |    | pin 2 (RXD) |
| pin 2,3 (RXD)              | to | pin 2 (TXD)                    |    | pin 3 (TXD) |
| pin 1 (CTS)                | to | pin 4 (RTS)                    |    | pin 7 (RTS) |
| pin 4 (BUSY)               | to | pin 20 (DTR)                   |    | pin 4 (DTR) |
| shield (GND)               | to | pin 7 (GND)                    |    | pin 5 (GND) |

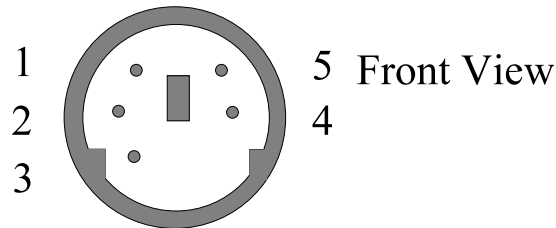

*Figure 5 - Connector Pin-outs*

## **4.3 Functional Description**

**Oxitest Plus 7** RS-232 commands are ASCII strings consisting of two to four upper case letters followed by zero to three numeric digits. Command strings are terminated with the carriage return character (0D hex), or by carriage return followed by the line feed character (0A hex).

The **Oxitest Plus 7** has a bidirectional RS-232 port and monitors the RTS and DTR lines when handshaking with external serial printers. Control programs should ensure that COM port RTS and DTR lines are set high and that at least 100 msec is allowed between transmissions to accommodate command execution time. A delay of less than 100 msec between transmissions may produce unexpected results.

If **Oxitest Plus 7** receives a valid RS-232 command, **Oxitest Plus 7** will execute the command, update the LCD to reflect the change and transmit the “\*” character via its RS-232 port. If **Oxitest Plus 7** receives an invalid or erroneous command, the command will not be executed, the **Oxitest Plus 7** will transmit the “?” character via its RS-232 port.

## **4.4 Command Definitions**

*For all RS-232 commands, be sure to follow the prescribed syntax, including leading zeros where indicated. Failure to do so may result in unexpected operation of the **Oxitest Plus 7**.*

### **4.4.1 Select Oximeter and Initialize Simulation Command**

Format:

`Oxmmm` where `mmm` = 001 for BCI 3300  
002 for BCI 3300/Nellcor  
003 for BCI 3302  
...  
059 for SpaceLabs Scout with Nellcor sensor

Example:

`OX032` causes **Oxitest Plus 7** to select and initialize the Nellcor N-20P patient simulation.

Note the value of `mmm` corresponding to the oximeter make/model listed above is also displayed at the bottom right corner of the **Oxitest Plus 7** LCD when the user presses the **Pulse Ox** key on the front panel.

The OX command will cause **Oxitest Plus 7** to select the specified oximeter whether or not the oximeter has been ENabled via the PULSE OX SETUP menu. The OX command also initializes SpO<sub>2</sub>, heart rate and pulse amplitude to default values of 97%, 60 BPM and 100% respectively. The status display is reset to "NO SIGNAL".

**Note:** As oximeters are added to the **Oxitest Plus 7** menu by firmware upgrade, the number **mmm** may change. Be sure to check the number of any oximeter following a new software release, and update any software programs, as necessary. The numbers given above are for example only, and may not be representative of the current software version.



#### **4.4.5 Activate Artifact Simulation**

Format:

AFn activate artifact simulation *n*,  
where *n* =        Ø for OFF  
                  1 for movement  
                  2 for spike  
                  3 for tremor

Examples:

AFØ sets the Artifact Simulation off  
AF3 sets the Tremor Artifact simulation on

#### **4.4.6 Activate Auto Preset Protocol**

Format:

APn **Oxitest Plus 7** reverts to manual control mode with the  
test protocol defined by Auto Preset protocol *n*,  
where                                 $1 \leq n \leq 9$

Examples:

AP2 sets SpO2=80%, HR=95 BPM, PA=100%  
AP8 sets SpO2=97%, HR=70 BPM, PA=33%, ART= Movement

#### **4.4.7 Download Test Report**

Format:

DLTR download test report (complete)

Example:

See example Test Report in Section 3.12.

#### **4.4.8 Download Manual Record**

Format:

GMNrr download Manual record rr,

where  $01 \leq rr \leq 20$

Example:

GMN12 downloads the 12<sup>th</sup> Manual test record (40 characters)

#### **4.4.9 Download Auto Preset Test Record**

Format:

GAUx download Auto Preset test record x,

where  $1 \leq x \leq 9$

Example:

GAU3 downloads the 3rd Auto Preset test record (40 characters)

#### **4.4.10 Download Alarm Test Record**

Format:

GATt download Alarm Test record t,

where t =  
1 for LOW SAT,  
2 for HI RATE,  
3 for LOW RATE,  
4 for LOW SIG, and  
5 for ARTFACT.

Example:

GAT1 downloads the LOW SAT Alarm Test Record (35 characters)

#### **4.4.11 Erase All Test Records**

Format:

**EALL**      erase all test records (manual, Auto Preset and Alarm Tests)



#### **4.4.12 Command Summary**

| <u>Command</u> | <u>Function</u>  |
|----------------|--|
| <b>AFn</b>     | Activate artifact signal <i>n</i> , where:<br>n = Ø for OFF<br>n = 1 for movement<br>n = 2 for spike<br>n = 3 for tremor                             |
| <b>APn</b>     | Activate preset protocol <i>n</i> , where $1 \leq n \leq 9$  |
| <b>DLTR</b>    | Download test report (complete)  |
| <b>EALL</b>    | Erase all test records (manual, Auto Preset and Alarm Tests)   |
| <b>GATt</b>    | Download Alarm Test record <i>t</i> , $1 \leq t \leq 5$  |
| <b>GAUx</b>    | Download Auto Preset record <i>x</i> , $1 \leq x \leq 9$   |
| <b>GMNrr</b>   | Download Manual record <i>rr</i> , $\text{Ø} \leq rr \leq 2\text{Ø}$   |
| <b>HRrrr</b>   | Set heart rate to <i>rrr</i> BPM, $2\text{Ø} < rrr \leq 25\text{Ø}$  |
| <b>OXmmm</b>   | Set Pulse Ox to # <i>mmm</i> and restart simulation  |
| <b>PAaaa</b>   | Set pulse amplitude to <i>aaa</i> per-cent, $\text{Ø} \leq aaa \leq 1\text{ØØ}$  |
| <b>SOx</b>     | Set SpO <sub>2</sub> to level <i>x</i> , where<br>x = 1 for 97%<br>x = 2 for 93%<br>x = 3 for 90%<br>x = 4 for 80%<br>x = 5 for 70%<br>x = 6 for 55% |











## **4.5 Programming Example**

Microsoft QBasic is an easy-to-use BASIC interpreter which is supplied as part of Microsoft DOS versions 5 and later. Using QBasic, you can write simple programs on your IBM PC or compatible to control **Oxitest Plus 7** automatically via a COM port.

Below is a simple program written in Microsoft QBasic which causes **Oxitest Plus 7** to select a NELLCOR N-200 pulse oximeter for testing and automatically sweep the N-200 through a range of SpO<sub>2</sub> and heart rate settings.

Run Microsoft QBasic from the DOS prompt by simply typing *QBasic* followed by  (you can also run QBasic from Windows - double click on the QBasic icon in the APPLICATIONS group.) QBASIC should boot, showing the "Welcome" screen. Press  to clear the screen, or press  to view the QBasic HELP index.

When typing the following example, be sure to include all the punctuation marks which appear in the program ( " , ; ! % \$ and so on).

After you have typed in the program, save it by typing  , followed by . To run the example, connect **Oxitest Plus 7** to COM1, set up the NELLCOR N-200, and then type   followed by . To stop the program, press the  key. To quit QBASIC, type   followed by .

*Program Example*

```
CLS
PRINT "NELLCOR pulse oximeter SpO2/Heart Rate
sweep"
PRINT "Press <ESC> to quit": PRINT
PRINT "      SpO2 (%)      Heart Rate (BPM)"
VIEW PRINT 5 TO 6

' Open COM1 for serial communications at 9600 baud
OPEN "COM1: 9600,N,8,1,CD0,CS0,DS0,OP0,RB32,TB32"
FOR OUTPUT AS #1

' Select NELLCOR N-200 pulse oximeter
' Note the following command may change with
changes
' in Oxitest software revision. The command OX035
is
' used here only as an example.

PRINT #1, "OX035"
INPUT #1, C$
SpO2% = 1
DO
    ' Set the SpO2
    PRINT #1, "SO";
    PRINT #1, USING "#"; SpO2%
    INPUT #1, C$
    GOSUB CommDelay
    ' Sweep the heart rate from 60 to 140 BPM
    FOR HeartRate% = 60 TO 140 STEP 20
        PRINT #1, "HR";
        IF HeartRate% < 100 THEN
            PRINT #1, USING "##"; HeartRate%
        ELSE
            PRINT #1, USING "###"; HeartRate%
        END IF
        INPUT #1, C$
        ' Display current SpO2 and HR on PC screen
        SELECT CASE SpO2%
            CASE 2:
                O2sat% = 93
```

```
        CASE 3:
            O2sat% = 90
        CASE 4:
            O2sat% = 80
        CASE 5:
            O2sat% = 70

        CASE ELSE
            O2sat% = 97
    END SELECT
PRINT "          "; O2sat%; "          ";
HeartRate%

' Delay 20 sec before next heart rate increment
  FOR i% = 1 TO 100
    GOSUB CommDelay
    ' Quit if user presses ESCape key
    IF INKEY$ = CHR$(27) THEN
      CLOSE
      END
    END IF
  NEXT i%
NEXT HeartRate%

' Select next saturation level
SpO2% = SpO2% + 1
IF SpO2% > 5 THEN
  SpO2% = 1

  END IF
LOOP WHILE SpO2% > 0
END

' This subroutine produces a timed delay of 200
msec
CommDelay:
  TeeZero! = TIMER
  DO WHILE TIMER - TeeZero! < .2: LOOP
RETURN
```

## 5. Test Usage Guidelines

### 5.1 General Rules

In an ideal world, testing a pulse oximeter would simply involve placing the oximeter sensor on the test probe and observing the results. However, due to the many implementations of the basic oximetry technology and many configurations of sensors, there are some practical problems you will inevitably run into in testing oximeters. The problems generally fall into two categories: 1) interpretation of results; and 2) the probe/sensor interface.

#### 5.1.1 Interpretation of Results

Although pulse oximeters provide an indication of heart rate, it is the oxygen saturation estimated by these devices ( $SpO_2$ ) which is of greater concern when discussing the "accuracy" of a particular make or model. Manufacturer's accuracy specifications for  $SpO_2$  can be confusing - just what does  $\pm 2\% \pm 1$  standard deviation actually mean? In developing the calibration curve for an oximeter, commonly known as the "R-Curve", the response of the device is statistically compared to the response from invasive oxygen content readings from a large population of individuals. The specification cited above can be translated as: the oxygen saturation value measured by this oximeter will be accurate to within 2% for 65% of the population.

This specification has very little to do with what you should expect from testing the oximeter with a tester. The R-Curve is well-defined in the oximeter's electronics. An oximeter tester such as **Oxitest Plus 7** is microprocessor controlled, and as a result outputs a precisely regulated, calibrated optical signal. Therefore, although there may be some uncertainty introduced by the sensor and the sensor/tester interface, the response from an electro-optical simulation should be within the tester's specification limits of  $\pm 1\%$ . In some cases, a response outside of these limits is an indication that the sensor is slightly out of tolerance and replacement should be considered.

## OXITEST PLUS 7 OPERATING MANUAL

When using **Oxitest Plus 7**, the primary consideration is to first choose the correct make, model and sensor type for the device under test. Many manufacturers of oximeters use another company's technology, for instance, Tyco provides Nellcor technology on an OEM basis to a large number of physiological monitor manufacturers. Each of these individual manufacturers may use the R-Curve developed by Nellcor, or they may decide to develop their own curve. In addition, they may use the Nellcor sensors, or manufacture a sensor under their own brand name. These same manufacturers may use both Nellcor sensors and their own, implementing a different R-Curve for each sensor. With all of these combinations possible, it is very important to select the correct pulse oximeter and sensor type in the menu to ensure that the simulation is correct for the unit under test.

Disposable sensors can produce questionable results when used with 'compatible' oximeters. For instance, Nellcor makes a disposable finger sensor which, due to the cable connector, can be attached to many other manufacturer's oximeters. In order to have a better manufacturing yield, Nellcor 'codes' the disposable sensor with a resistor, which the Nellcor oximeter uses to adjust the R-Curve for the sensor. In effect, this is providing compensation for the optical response of the sensor. However, even though the Nellcor disposable sensor fits on other manufacturer's cables, it may not provide reliable results - especially at the lower saturation levels - if the R-Curve variation is not taken into account.

### 5.1.2 **Probe/Sensor Interface**

The single most variable parameter in testing oximeters is the fit between the tester probe and the oximeter sensor. Due to the wide variety of sensor shapes, a test probe which provides an excellent fit with a Nellcor sensor may not be as good a fit to a Nonin sensor. The **Oxitest Plus 7** probe has been designed to provide the best-compromise fit for testing both disposable and nondisposable sensors across many brands.

Most *nondisposable* sensors fit into two categories of design: 1) Nellcor style - with an 'end stop' for the finger or 2) Ohmeda style - with a 'finger depression' molded in the sensor. In many cases, the sensor can be simply slid over the test probe and will sit 'naturally' in place. If you do not get good results with this method, the following instructions should improve the results:

#### 1) Nellcor (Tyco) Style

The Nellcor style sensor generally utilizes a soft, cushiony material to surround the finger, with a hard plastic or metal outer shell. Inside there is an 'end stop' to prevent the finger from going too far into the sensor. Examples of this type include Nellcor, Nonin, and SpaceLabs/Novamatrix finger clip sensors. The 'end stop' of the Nellcor DS-100A finger clip sensor can be seen in *Figure 6*.

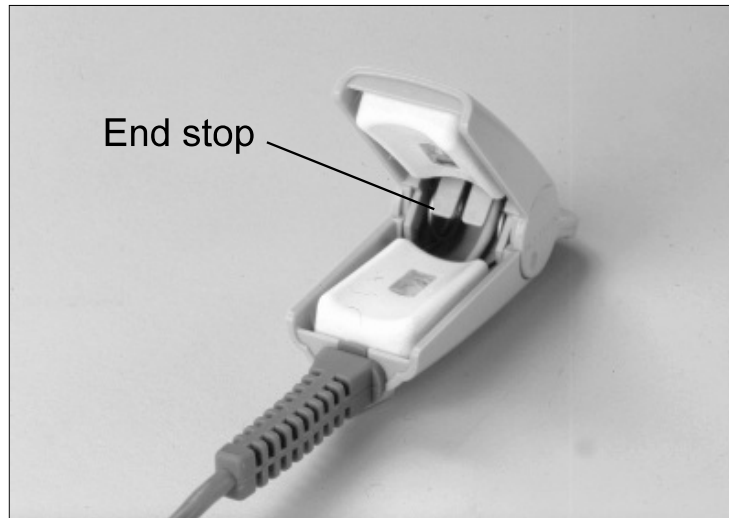

*Figure 6 - Nellcor DS-100A finger clip sensor*

With the oximeter turned ON, hold the sensor in the open position, with the LEDs (they should be glowing red) shining toward you - the photo detector will be closest to you, hidden by the hard sensor shell. Place the photo detector on the **Oxitest Plus 7** probe, with the end of the probe touching the 'end stop'. Allow the sensor to close around the test probe, keeping intimate contact on the upper, photodetector side. *It is important to retain the tight, intimate contact on the photodetector side to prevent leakage of light from the sensor LEDs on the bottom reaching the photodetector on the top.*

Most finger clip sensors are configured such that, when applied to the test probe, the cable will lead off *toward* the **Oxitest Plus 7**. In this case, the sensor cable should be routed via the probe compartment so that the cable leads off toward the the "LCD end" of **Oxitest Plus 7**, rather than toward the bottom of the tester. The **Oxitest Plus 7** probe incorporates a cutout designed to accommodate stiff or long strain reliefs found on some oximeter cables. This helps prevent stiff cables from inadvertently pushing the sensor off the probe. Stiff cables or long strain reliefs can be pre-formed to the desired shape before application to the probe.

## OXITEST PLUS 7 OPERATING MANUAL

### 2) Ohmeda (Datex) Style

The Ohmeda style sensor uses a harder rubber-like material to surround the finger, taking the finger shape into consideration with a depression in the material. The outside of the sensor is commonly a hard plastic, molded in the shape of a clothes pin. Examples of this type include Ohmeda, SiMed and Physio-Control finger clip sensors. The depression of the Ohmeda finger clip sensor can be seen in *Figure 7*.

With the LEDs shining toward you, as in the Nellcor example, place the sensor on the test probe so that the upper bulge on the probe fits into the sensor depression. Allow the sensor to close, maintaining intimate contact between the photodetector side of the sensor and the upper side of the test probe. *It is important to retain the tight, intimate contact on the photo-detector side to prevent leakage of light from the sensor LEDs on the bottom reaching the photodetector on the top.*

As with the Nellcor-style sensor, a stiff sensor cable or long strain relief can be pre-formed before the sensor is applied to the **Oxitest Plus 7**, and the cable routed via the probe compartment before leading off to the oximeter under test.

Other sensor styles may also require careful placement:

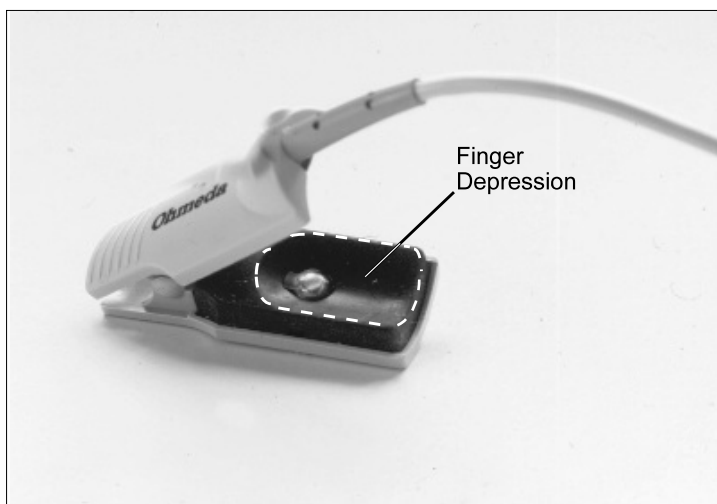

*Figure 7*

## OXITEST PLUS 7 OPERATING MANUAL

### 3) Hewlett-Packard (Agilent / Philips) M1190A and M1191A sensors

The Hewlett-Packard M1190A and M1191A sensors are made from a pliable rubber compound, with a slit opening at the distal end of the sensor. Slide the sensor onto the **Oxitest Plus 7** probe with the LEDs shining toward you.

*Push the sensor onto the probe until the probe tip extends out of the sensor slit by about 1/8".*

Ensure that the photodetector (the bulge on the top of the sensor) is located on the centerline of the test probe.

Correct placement of the Hewlett-Packard M1190A can be seen in *Figure 8*, with the sensor cable leading off to the oximeter via the probe compartment of the **Oxitest Plus 7**.

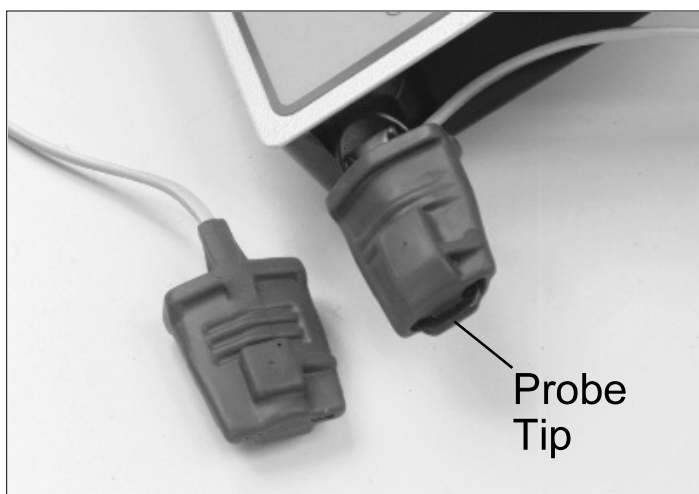

*Figure 8 - Correct Placement of HP M1190A sensor*

### 4) Disposable and Flexible Sensors

Disposable and flexible sensors come in many shapes and sizes depending on their use - neonatal, flexible finger sensor, ear clip, etc. In applying these sensors to the test probe, place the photodetector on the center of the upper optical window of the probe. Wrap the sensor around the probe, with the LED portion of the sensor ending up somewhere on the lower optical window of the probe (it is not critical where). The sensor can be held in place with tape, if required.

*Regardless of the actual design of the sensor, the key to good readings is to develop a tight, intimate contact on the photodetector side of the sensor/probe interface, to prevent leakage of light from the sensor LEDs reaching the photodetector.*

**OXITEST PLUS 7 OPERATING MANUAL**

Correct placement of typical flexible sensors is shown in *Figure 9* through *Figure 11*.

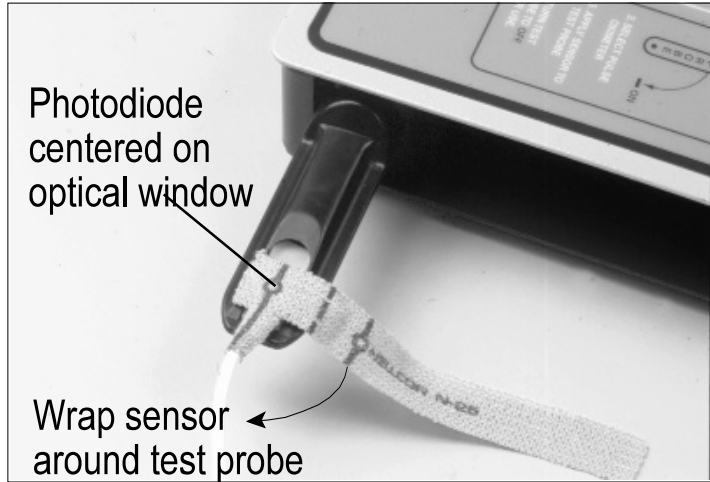

*Figure 9 - Nellcor N-25 neonatal disposable*

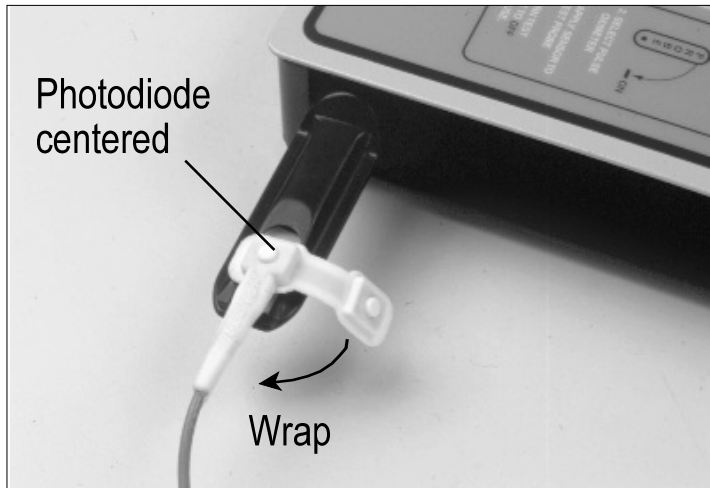

*Figure 10 - Nellcor Oxi-A/N sensor*

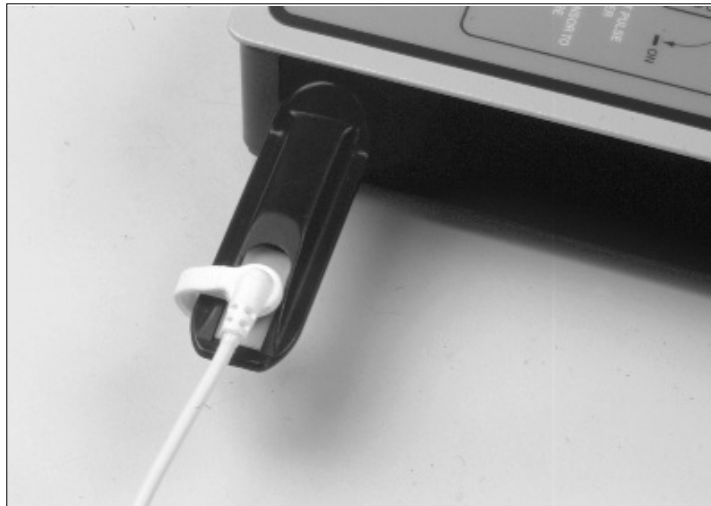

*Figure 11 - Obmeda Flex II sensor*

5) Application of Criticare Sensors

Although the Criticare 511 and 934 sensors are generally compatible with the **Oxitest Plus 7** probe (i.e. the Oxitest "finger"), the fit is less than ideal. Despite this, fairly good results can be obtained when testing Criticare pulse oximeters by following these rules (note in all cases the sensor LEDs are on the "bottom", and the sensor's photodiode is on "top"):

a) *Criticare 511 Sensor*

An acceptable position for the 511 sensor is as follows:

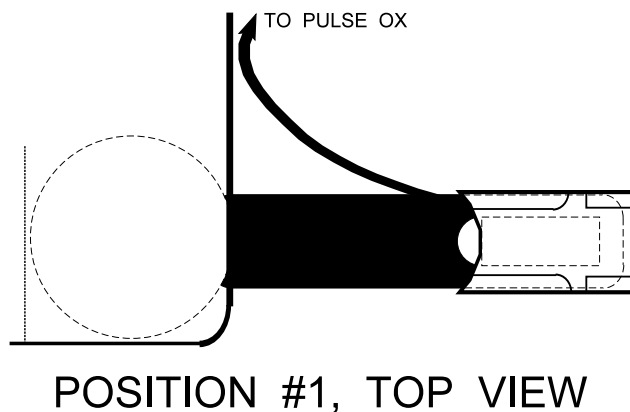

*Figure 12*

## OXITEST PLUS 7 OPERATING MANUAL

Position #1 is achieved by simply sliding the 511 sensor onto the tip of the **Oxitest Plus 7** probe, until the sensor just comes to a "stop". Position #1 is a good "starting position", but it is not the best position as interference from the 511's LEDs can leak around the **Oxitest Plus 7** probe tip to reach the 511's photodiode, upsetting the calibration of the SpO<sub>2</sub> simulation.



### POSITION #1, SIDE VIEW

*Figure 13*

Position #2, illustrated below, is preferable since it achieves better optical isolation between the 511's LEDs and photodiode. Position #2 is achieved by pushing the 511 from Position #1 until the sensor comes to a solid "stop". The lower jaw of the 511 will swing down to accommodate the probe tip, and the upper jaw will lie flatter along the upper surface of the probe. Try Position #2 after the pulse oximeter has stabilized for at least 30 seconds in response to the **Oxitest Plus 7's** signal.

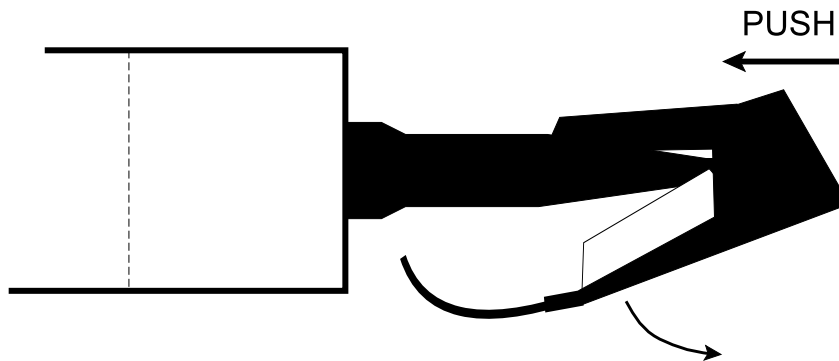

### POSITION #2, SIDE VIEW

*Figure 14*

**OXITEST PLUS 7 OPERATING MANUAL**

b) *Criticare 934 Sensor*

Generally, a good position for the 934 sensor appears as follows when viewed from the top:

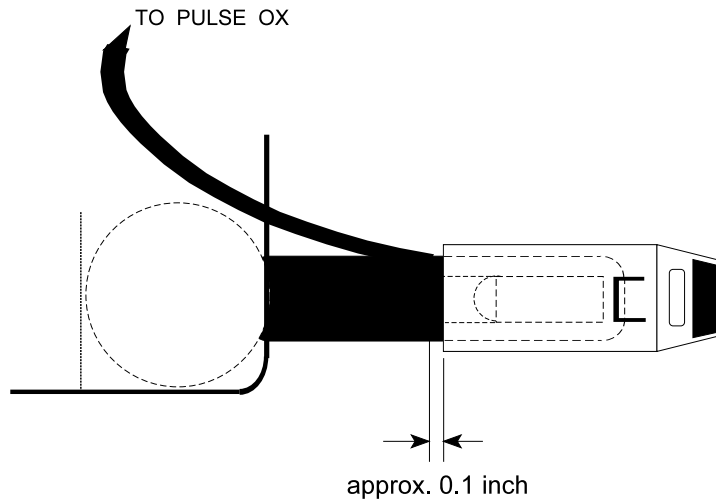

*Figure 15*

A simple way to apply the 934 sensor is to slide it over the end of the **Oxitest Plus 7** probe, stopping when you feel that the **Oxitest Plus 7** probe tip just reaches, but does not "ride over", the end of the finger depression inside the sensor. The position of the 934 sensor will be roughly as shown in the above diagram.

Note that if the 934 sensor is "jammed all the way" onto the **Oxitest Plus 7** probe, most of the optical signal radiated from the probe will be blocked and will not reach the photodiode of the sensor. In this case, the pulse oximeter will not display an SpO<sub>2</sub> or heart rate indication, or a proper pleth waveform.

**5.2 Diagnosing Sensor Faults**

Use the following table when troubleshooting pulse oximeter sensor and cable problems, with the help of the **Oxitest Plus 7**'s STATUS display.

| STATUS DISPLAY | PROBABLE FAULT(S)   |
|----------------|---|
| NO RED         | <ul style="list-style-type: none"> <li>- RED LED is defective. This is normally evident if RED LED is not visible when viewing sensor</li> <li>- sensor cable(s) have an open or intermittent wire contact, or cable connector(s) are defective</li> <li>- RED LED drive signal from oximeter is missing</li> </ul>   |
| NO IR          | <ul style="list-style-type: none"> <li>- INFRARED LED is defective. This is <i>NOT</i> evident when viewing sensor</li> <li>- sensor cable(s) have an open or intermittent wire contact, or cable connector(s) are defective</li> <li>- INFRARED LED drive signal from oximeter is missing</li> </ul>   |
| NO SIGNAL      | <ul style="list-style-type: none"> <li>- both RED and INFRARED LEDs are faulty</li> <li>- sensor cable(s) have an open or intermittent wire contact, or cable connector(s) are defective</li> <li>- both RED and INFRARED LED drive signals from oximeter are missing</li> </ul>  |
| RED+IR OK      | <ul style="list-style-type: none"> <li>Oximeter displays “Low Light”, or “Insufficient Light”, and may alarm.</li> <li>- Photo detector in sensor is faulty</li> <li>- sensor cable(s) have an open or intermittent wire contact, or cable connector(s) are defective</li> <li>- Photo detector circuitry in oximeter is defective or out of calibration</li> </ul> |

Intermittent contacts in the cable or connectors can be confirmed by twisting the cable (hold the sensor on the test probe if twisting near the sensor). The LCD STATUS display will change from the error code listed above to “TESTING...”. When “TESTING...”, the **Oxitest Plus 7** has recognized a new signal and is checking to confirm that both RED and IR signals are present and correctly timed for the oximeter under test.

For testing of the probe sensor cable, see Datrend’s companion test instrument: Sensitest.

### **5.3 Cross-Manufacturer Compatibility**

Nellcor and Ohmeda are examples of two leading pulse oximeter manufacturers which license the use of their technology to other medical device companies, primarily manufacturers of patient monitoring systems. Pulse oximeters which employ licensed technology can sometimes (but not always) be identified by the oximeter sensor - if the device is compatible *only* with a Nellcor (or Ohmeda) sensor, it is possible that the unit contains a licensed OEM version of the Nellcor (or Ohmeda) technology.

It may be possible to test the SpO<sub>2</sub> portion of such monitors using one of the *Nellcor* or *Ohmeda* settings on **Oxitest Plus 7**. As products mature, manufacturers modify the electronics or the software of newer models to improve performance. As a result, not every model from one manufacturer can be tested using the same setting. OEM versions of a manufacturer's product will also exhibit the same type of variations. Therefore, even though two companies have licensed Nellcor technology, one may be a N-200 type implementation, and the other may be a N-180 type implementation. If you are trying to test an OEM product, try each of the OEM original model settings to determine which one performs best.



## 6. Routine Maintenance

### 6.1 Probe Cleaning

Over a period of time, a build-up of residue may be noticed on the optical windows at the probe tip. This is normal and is due to contact with dirty sensors and disposable sensors which rely on adhesive application.

To ensure the probe receives maximum light from sensors under test, and also to ensure that the optical power emitted by the probe remains within its calibrated range, the probe should be cleaned regularly. Normally, simply wiping the optical windows with a soft cloth dampened with water is all that is required. Detergent solutions are rarely required but acceptable at low concentrations.

**DO NOT** use isopropyl alcohol to clean the acrylic probe, as it will introduce stress cracks over time.

*The Oxitest probe incorporates urethane, acrylic and mylar components. Therefore, under no circumstances should reactive solvents (adhesive remover, varsol, turpentine, etc) be used to clean the probe.*

## **6.2 Calibration**

Calibration of **Oxitest Plus 7** by a Datrend Authorized Service facility is recommended on an *annual* basis, and is *required* to extend the product warranty. The basic one (1) year warranty can be extended to a maximum of five (5) years provided that annual calibration is performed by a Datrend Authorized Service Center on an *annual* basis.

The **Oxitest Plus 7** can only be *CALIBRATED* with specialized equipment and software found at Datrend authorized service facilities. This equipment allows proper adjustment of the internal electronics of the instrument.

Independent service providers *may* be able to perform a performance *VERIFICATION*; however, they will NOT be able to perform repairs or adjustments to your **Oxitest Plus 7**. Use of an unauthorized facility for service and/or calibration will void your warranty.

When calibration is due, contact Datrend Customer Service to determine the authorized service facility nearest your location and to obtain an RMA number. In North America: 1-800-667-6557; Outside North America: (604) 291-7747; e-Mail: [customerservice@datrend.com](mailto:customerservice@datrend.com)