SIGMA 1 AC

OPERATING MANUAL

I. COPYRIGHT KONTRON

All rights reserved. The information contained in this publication may not be used for any purpose other than that for which it was originally supplied. The publication may not be reproduced in part or in whole without written consent of Kontron Instruments. In order to maintain and improve standards of manufacturing, methods of functioning and to increase reliability, Kontron Instruments equipments are periodically reviewed. For this reason, the contents of this publication are subject to change without notice.

This product contains Kontron Instruments Software, proprietary software in machine-readable form. Kontron Instruments retains all its rights, title and interest in the software; except that, purchase of this product includes a license to use the software contained in it. The purchaser shall not copy, trace, disassemble or modify the software, nor cause or allow this software to be copied, traced, disassembled or modified. Transfer of this product by the purchaser will constitute a transfer of this license, which will not be transferable otherwise.

The equipment described is manufactured by Kontron Instruments S.A. (Montigny Le Bretonneux, France), a member of the Kontron Instruments company.

II. QUALITY, RELIABILITY AND SAFETY

This equipment has been designed with an emphasis on quality, reliability and safety, but Kontron Instruments can only accept responsibility for these aspects providing the following conditions are met :

Electrical installations of the room or building in which the equipment is to be used must comply with regulations specified by the country in which the equipment is to be used.

The equipment is used in accordance with the instructions for use provided by Kontron (Operating manual).

All modifications and repairs to the equipment are carried out by authorized Kontron Instrument personnel, or their agents.

The equipment must comply with regulation specified in paragraph IV: Safety rules.

Your local Kontron Instruments company or agent is :
(To be entered by local Kontron Instruments company or agent.)

III. CAUTION

The Sigma 1 AC is designed to operate on a single phase line supply. The unit is automatically grounded via the power cable, provided that a 3-pin socket whose third pin is grounded, is used. The patient's bed can be connected to the unit through the equalization potential terminal provided for this purpose on the rear panel of the unit.

Take all appropriate precautions to avoid impact damage to the active face of the transducer. Protect the transducer with the black part of the transducer's holder which can be removed from the support.



For extended storage or when the unit is to be out of use, the batteries should be removed from Polaroid camera : leakage of the caustic battery solution may cause irreparable damage.

Unused film should be remove and rollers cleaned.

The use of not approved products by Kontron Instruments such as oil, Mercurochrome or methylene blue or ether could cause permanent damage to the sensitive part of the transducer.

Only the Kontron Instruments supplied gel (Sigma 1 AC supply part number 581 003, 250 cc ultrasonic gel) is recommended by Kontron Instruments for use with SIGMA 1 transducers. The use of an agent, other than the approved gel, may adversely affect the quality of the scanning images and produce substandard results.

Indications :

-  AC line Input
-  Safety ground fed by line cord
-  Equalization potential terminal
- Isolated E.C.G. Input

IV. SAFETY RULES

The Sigma 1 family manufactured by Kontron Instruments S.A, entirely comply with the safety regulation IEC 601-1.

When interconnecting two or more equipments, especially equipments not manufactured by the Kontron Group (video recorders, external TV monitors...), no external system connected to the Sigma's should have an external power source other than the system cart ref.: 588 660 which is equipped with the correct transformer.

In case of using another device than the one above recommended, Kontron Instruments S.A would commit its responsibility only if the safety regulations already mentioned are fulfilled.

For information, the IEC 601-1 regulation for medical equipment class 1 type B specifies :

- . Leakage current to ground must be less than 0.1 mA in normal condition.
- . Leakage current to ground must be less than 0.5 mA in single fault condition.
- . Isolation voltage between ground and mains live wires must be higher than 1500 V.

IMPORTANT

IF AN EXTERNAL ISOLATING TRANSFORMER IS CONNECTED TO THE EQUIPMENT, THIS ONE MUST COMPLY WITH SPECIFICATIONS GIVEN IN SECTION 5.7 .

TABLE OF CONTENTS

TABLE OF CONTENTS

Section 1

| | |
|---|------|
| INTRODUCTION | 1-1 |
| 1.1 Physical description | 1-3 |
| 1.1.1 Sigma 1 AC operating conditions | 1-3 |
| 1.1.2 Optional equipment | 1-4 |
| 1.2 Functional description | 1-8 |
| 1.3 Sigma 1 AC medical applications | 1-9 |
| 1.3.1 Cardiology | 1-9 |
| 1.3.2 Gynecology / Obstetrics | 1-9 |
| 1.3.3 Internal medicine | 1-9 |
| 1.4 Configuration recognition | 1-10 |
| 1.5 Table of different Sigma 1 AC types | 1-10 |
| 1.6 Table of different Sigma 1 AC ANNULAR types | 1-10 |

Section 2

| | |
|---|------|
| CONTROL, INDICATOR AND CONNECTORS | 2-1 |
| 2.1 Sigma 1 AC front panels | 2-3 |
| 2.1.1 Multifunction softkeys | 2-7 |
| 2.1.2 Alphanumeric keyboard | 2-8 |
| 2.1.3 Function Keys | 2-10 |
| 2.1.3.1 Using processing keys | 2-15 |
| 2.1.3.1.1 Preprocessing | 2-15 |
| 2.1.3.1.2 Postprocessing | 2-16 |
| 2.1.3.1.2.1 Filter | 2-16 |
| 2.1.3.1.2.2 Near/Far | 2-17 |
| 2.1.3.1.2.3 Image generation techniques | 2-18 |
| 2.1.3.2 Using the position keys | 2-19 |
| 2.1.3.3 Using measurement keys | 2-20 |
| 2.1.3.3.1 2D Dual distance | 2-20 |
| 2.1.3.3.2 2D area/circumference | 2-20 |
| 2.1.3.3.3 TM dual distance | 2-21 |
| 2.1.3.3.4 TM slope | 2-22 |
| 2.1.4 Trackball | 2-23 |
| 2.1.5 Adjustment, controls and indicators | 2-23 |
| 2.1.6 Connectors | 2-24 |
| 2.2 Sigma 1 AC rear panel | 2-26 |

Section 3

| | |
|--|------|
| OPERATION | 3-1 |
| 3.1 Sigma 1 AC make-ready | 3-3 |
| 3.1.1 Power supply | 3-3 |
| 3.1.2 Polaroid camera | 3-3 |
| 3.1.3 Cables and connections | 3-3 |
| 3.2 Initial procedures | 3-4 |
| 3.2.1 Turn-on | 3-4 |
| 3.2.2 Personal parameters settings | 3-5 |
| 3.2.2.1 General parameters | 3-5 |
| 3.2.2.2 Sound velocity | 3-6 |
| 3.2.2.3 Permanent clock/calendar | 3-6 |
| 3.2.3 Contrast and intensity adjustments | 3-7 |
| 3.2.4 Transducer and patient preparation | 3-7 |
| 3.3 Typical settings for 2D imaging | 3-8 |
| 3.3.1 Mode selection | 3-8 |
| 3.3.2 Parameters selections | 3-8 |
| 3.3.3 2D image measurements procedures | 3-15 |
| 3.3.3.1 Distance | 3-15 |

TABLE OF CONTENTS [continued]

Section 3 OPERATION [continued]

| | |
|---|------|
| 3.3.3.2 Area/circumference | 3-16 |
| 3.4 Typical settings for TM and 2D/TM imaging | 3-17 |
| 3.4.1 Mode selection | 3-17 |
| 3.4.2 Parameter selection | 3-17 |
| 3.4.3 TM and 2D/TM image measurement procedures | 3-20 |
| 3.4.3.1 Distances and ratio | 3-20 |
| 3.4.3.2 Slope | 3-21 |
| 3.5 Displays | 3-22 |
| 3.6 Cine mode | 3-34 |
| 3.6.1 Storing pictures | 3-34 |
| 3.6.2 Displaying pictures image by image | 3-36 |
| 3.6.3 Displaying pictures as movie | 3-36 |
| 3.6.4 Changing the running speed | 3-36 |
| 3.6.5 Stopping movie | 3-37 |
| 3.6.6 Exit of the cine mode | 3-37 |

Section 4

| | |
|---|------|
| BIOMETRY | 4-1 |
| 4.1 Biometric functions | 4-3 |
| 4.1.1 General | 4-3 |
| 4.1.2 Conventions | 4-3 |
| 4.1.3 Positioning Markers | 4-3 |
| 4.1.4 Biometric functions flow chart | 4-4 |
| 4.2 General measurements | 4-5 |
| 4.2.1 Angle | 4-5 |
| 4.2.2 Slope | 4-5 |
| 4.3 Obstetrics and gynecology | 4-6 |
| 4.3.1 Biparietal Diameter | 4-6 |
| 4.3.2 Thorax diameter | 4-7 |
| 4.3.3 Abdominal diameter | 4-8 |
| 4.3.4 Femur length | 4-9 |
| 4.3.5 Crown rump length | 4-10 |
| 4.3.6 Gestational sac | 4-11 |
| 4.3.7 Hip angle | 4-12 |
| 4.4 Cardiology | 4-13 |
| 4.4.1 Ratio | 4-13 |
| 4.4.2 Teichholz | 4-14 |
| 4.4.3 Simpson | 4-15 |
| 4.4.4 Hemi-Ellipse | 4-16 |
| 4.4.5 Stroke volume and ejection fraction | 4-17 |
| 4.5 Internal medicine | 4-18 |
| 4.5.1 Residual Urine Volume | 4-18 |
| 4.6 User function | 4-19 |
| 4.6.1 Entering a new user function | 4-20 |
| 4.6.2 Using a user function | 4-21 |
| 4.6.3 Listing a user function | 4-21 |
| 4.6.4 Editing a user function | 4-22 |
| 4.6.4.1 Sound Vel. | 4-22 |
| 4.6.4.2 Line | 4-22 |
| 4.6.4.3 Clear F. | 4-23 |
| 4.7 Specific Biometry for U.S. Users | 4-24 |
| 4.7.1 Biometric functions | 4-24 |
| 4.7.1.1 General | 4-24 |
| 4.7.1.2 Conventions | 4-24 |
| 4.7.1.3 Positioning Markers | 4-24 |
| 4.7.1.4 Biometric functions flow chart | 4-25 |
| 4.7.2 General measurements | 4-26 |
| 4.7.2.1 Angle | 4-26 |
| 4.7.2.2 Slope | 4-26 |
| 4.7.3 Obstetrics and gynecology | 4-27 |

TABLE OF CONTENTS [continued]

Section 4 BIOMETRY [continued]

| | |
|---------------------------------------|------|
| 4.7.3.1 Biparietal Diameter | 4-27 |
| 4.7.3.2 Head circumference | 4-28 |
| 4.7.3.3 Abdominal circumference | 4-29 |
| 4.7.3.4 Femur length | 4-30 |
| 4.7.3.5 Crown rump length | 4-31 |
| 4.7.3.6 Gestational sac | 4-32 |
| 4.7.3.7 Binocular distance | 4-33 |

Section 5

| | |
|--|------|
| APPENDICES | 5-1 |
| 5.1 Sigma 1 AC installation and preparation for transport | 5-3 |
| 5.1.1 Introduction | 5-3 |
| 5.1.2 Unpacking | 5-3 |
| 5.1.3 Power source connection | 5-3 |
| 5.1.4 Matching the line voltage | 5-3 |
| 5.1.5 Safety rules | 5-4 |
| 5.1.6 Matching the TV standard | 5-4 |
| 5.1.7 Switching on for the first time | 5-4 |
| 5.1.7.1 Connections and Checks with Power OFF | 5-4 |
| 5.1.7.2 Testing with power ON | 5-4 |
| 5.1.8 Preparation for transport | 5-5 |
| 5.2 Sigma 1 AC polaroid camera use and routine maintenance | 5-6 |
| 5.2.1 Polaroid camera | 5-6 |
| 5.2.1.1 Checking the camera | 5-6 |
| 5.2.1.2 Loading the camera | 5-6 |
| 5.2.1.3 Loading the batteries | 5-6 |
| 5.2.1.4 Photography procedures | 5-7 |
| 5.2.1.5 Battery type | 5-7 |
| 5.3 Sigma 1 AC technical specification | 5-8 |
| 5.4 Sigma 1 AC transducer scanrates and formats | 5-11 |
| 5.5 Sigma 1 AC user/operator troubleshooting and maintenance | 5-15 |
| 5.5.1 Troubleshooting | 5-15 |
| 5.5.2 Cleaning | 5-15 |
| 5.5.3 Sterilization | 5-16 |
| 5.5.4 Repairs and maintenance | 5-16 |
| 5.6 Sigma 1 AC reference list | 5-17 |
| 5.6.1 English basic system | 5-17 |
| 5.6.2 French basic system | 5-17 |
| 5.6.3 U.S. basic system | 5-17 |
| 5.6.4 Options | 5-18 |
| 5.6.5 Transducers | 5-19 |
| 5.6.6 Disposables | 5-19 |
| 5.7 External isolating transformer technical specifications | 5-20 |

LIST OF FIGURES

| | |
|--|------|
| 1-1. The Sigma 1 AC basic unit | 1-2 |
| 1-2. Sigma 1 AC cart | 1-5 |
| 1-3. Polaroid camera (optional) | 1-5 |
| 1-4. Sigma 1 AC transducer types | 1-7 |
| 2-1. Front panels | 2-4 |
| 2-2. Rear panel | 2-26 |

1. INTRODUCTION

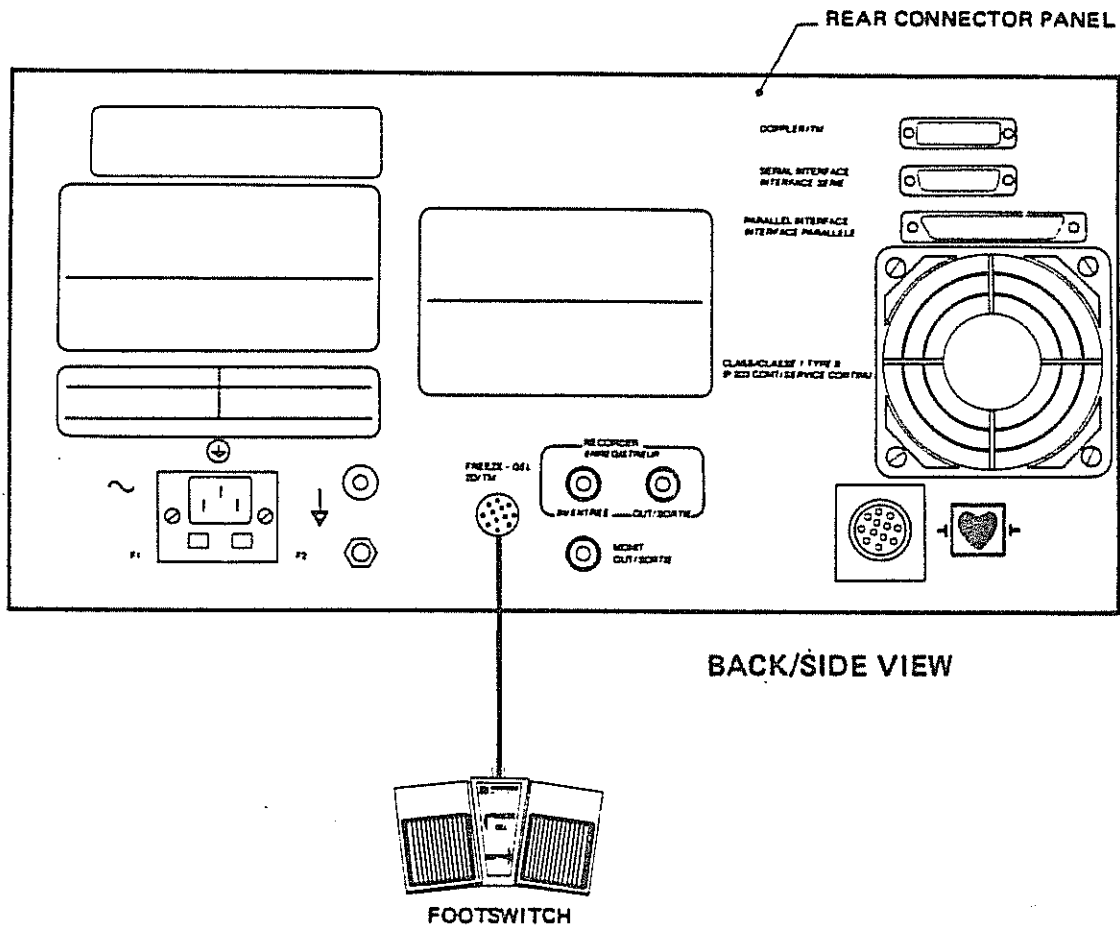
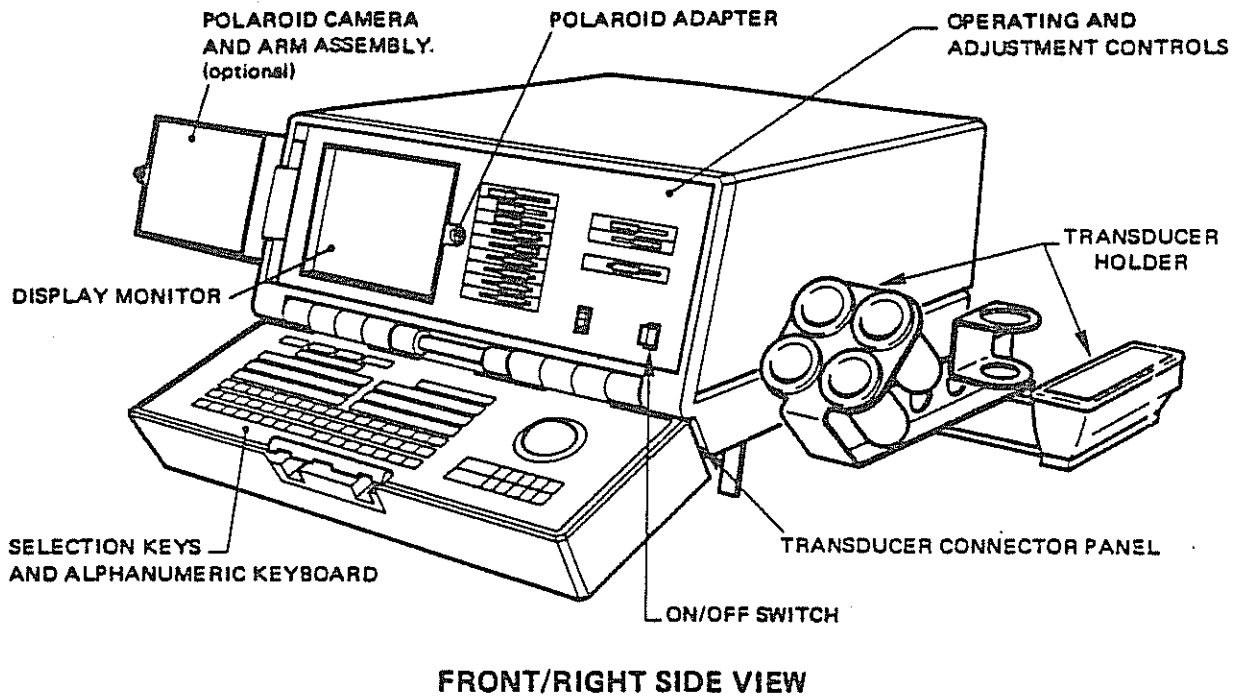

Figure 1-1 The Sigma 1 AC basic unit

1.1 Physical description

The Sigma 1 AC ultrasound diagnostic system (See Figure 1-1) is composed of a table-top unit that comprises :

Processing and imaging electronics. Circuitry and power supplies for image processing, memory and microprocessor.

Control panel. Operating and adjustment controls, selection keys and alphanumeric data input keyboard.

Display monitor.

Rear control panel. Signal input and output connectors.

Front connector panel. Transducer connectors.

Accessories. Power cable, bottle of gel, footswitch (Freeze/Defreeze and 2D/TM), transducer holder.

The dimensions of the Sigma 1 AC are 44 cm wide by 59 cm deep by 23 cm high and his weight is 28 Kg.

The unit is transportable and is normally placed on a free-standing table or cart (described in section "Optional equipment", page 1-4) for use wherever appropriate operating conditions exist.

1.1.1 Sigma 1 AC operating conditions

Power

The unit may be powered from a single-phase 110 V ac or 220 V ac $\pm 10\%$, 50 Hz or 60 Hz, electrical source that is in the compliance with regulations of the country in which the Sigma 1 AC is used. An agent or representative of Kontron Instruments will make any required modifications to accommodate the facility power supply at the time of the installation.

Temperature

The unit is designed for operation at an ambient temperature between $+10^{\circ}\text{C}$ and $+40^{\circ}\text{C}$.

Environment

The following environmental prohibitions apply:

The equipment must not be operated or serviced in the presence of flammable anesthetics.
Operation or servicing of the equipment in an environment of increased oxygen concentration is inadvisable.

1.1.2 Optional equipment

Cart

The optional cart (Figure 1-2) is specifically designed for the Sigma 1 AC as a permanent base for the unit and a convenient means of Sigma 1 AC conveyance to the bedside or patient examination location within the facility.

Additional features include :

- . Shelves to hold auxiliary equipment such as a video tape recorder (VTR) and line scan recorder (LSR).
 - . Power sockets for peripheral equipment connection.
 - . A storage drawer.
 - . Option : a lateral arm for mounting an optional side monitor on the right or left side of the Sigma 1 AC.
- If an external isolating transformer is connected to the equipment, this one must comply with specifications given in section 5.7**

Polaroid camera

The optional Polaroid camera (Figure 1-3) provides a quick reliable means of obtaining the screen image on a photograph for further study or medical records. The camera mounted on an arm at the left side of the unit, swings into exact position in front of the display screen for accurate focus.

Video tape recorder

Both JVC 6400 BR VHS and the PANASONIC 8500 video tape recorders record and play back the Sigma 1 AC system images with good resolution and fidelity to the original image. It is possible, however, to connect any VTR of professional quality to the Sigma 1 AC system and obtain very good results.

Line scan recorder

Line Scan Recorder produces "hard copy" information obtained with the Sigma 1 AC system. This LSR operates as a strip chart recorder for continuous Time-Motion (TM) mode recording, and as a line scan recorder for recording frozen 2D or TM images from the Sigma 1 AC system.

The Honeywell LS85 Model can be connected to Sigma 1AC with LSR cable. (Recording paper: 3M, 30 type 8100 Dry Silver).

Other systems, such as Tektronix, O.T.E..., can be used (Recording paper: 3M, 7772 Dry Silver). For more informations, contact your local representative or Kontron Instruments.

Thermal video printer

Thermal Video Printer prints a frozen 2D or TM image from Sigma 1AC System, on special paper.

Some Models (Mitsubishi, Sony,...) can be connected to Sigma 1AC. (Standard 75 ohms video cable).

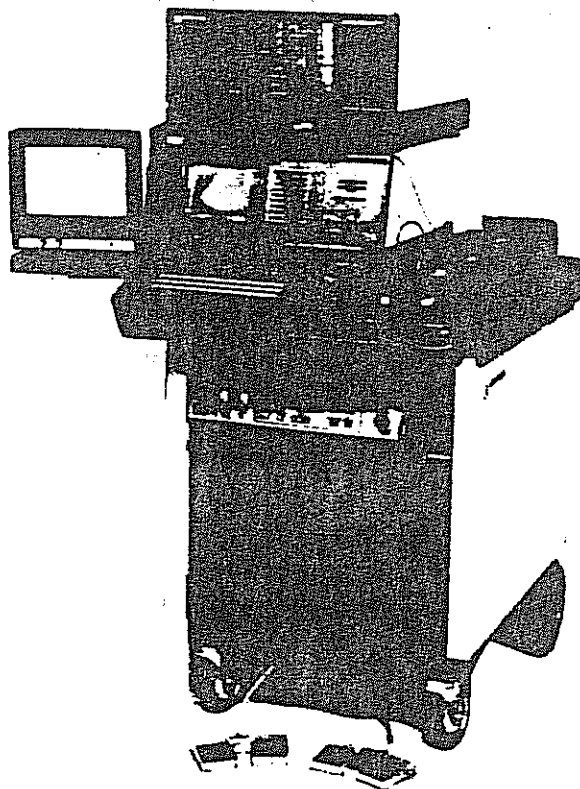

Figure 1-2 Sigma 1 AC cart

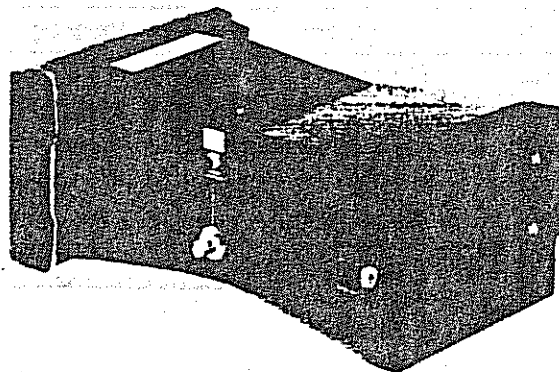

Figure 1-3 Polaroid camera (optional)

External monitors

The optional monitor has a screen that measure 9.5 inches (23, 75 cm) diagonally. The monitor can be positioned (on the optional Sigma cart) on the right-hand or left hand of the basic unit according to user preference.

Transducers

The Sigma 1 AC ultrasound imaging transducers (Figure 1-4) produce real-time images of soft tissue structure. Designed to allow excellent ergonometry for optimal positioning over the area of interest, they incorporate a small contact to provide easy regulation. Other design features include system-matched impedance that, together with a low-noise cable, assure the most favorable signal to noise ratio.

The transducers are connected to the Sigma 1 AC through a dedicated transducer port located on the panel situated on the front of the unit under the keyboard, as shown on Figure 1-1.

The features of the Sigma 1 AC transducers are compared in the following table.

| Scanhead family | Frequency (MHz) | Type | Use suggested |
|-----------------|-----------------|---------------|--|
| C | 3.5 | Sectorial | Cardiology |
| B | 3.5 | AA | Abdominal |
| D | 3.5 | Sectorial | CW Doppler compatible |
| A | 3.5 | Sectorial | Abdominal |
| A | 3.5 | AA | Abdominal |
| B | 5.0 | Sectorial | Universal and pediatric cardiology |
| B | 5.0 | AA | Universal and pediatric Abdominal |
| B | 7.5 | Sectorial | Vascular, small-parts, neonatology, pediatric cardiology |
| R | 7.5 | Sectorial | Rectal Investigations |
| V | 7.5 | Sectorial | Vaginal investigations |
| B | 7.5 | AA | Vascular, small-parts, neonatology, pediatric cardiology |
| | 3.5 | Linear | Obstetrics, abdominal, etc (universal) |
| | 5.0 | Linear | Proximal explorations |
| | 7.5 | Linear | Small parts |
| I/T | 7.5 | Linear | Intraoperative Investigations |
| R | 5.0 | Linear | Rectal Investigations |
| | 3.5 | Curved-linear | Obstetrics |

- A = Long Focus Family
- B = Medium Focus Family
- C = Short Focus Family
- D = CW Doppler Compatible Family

Note

All sectorial transducers are PW Doppler compatible

SECTORIAL TRANSDUCERS

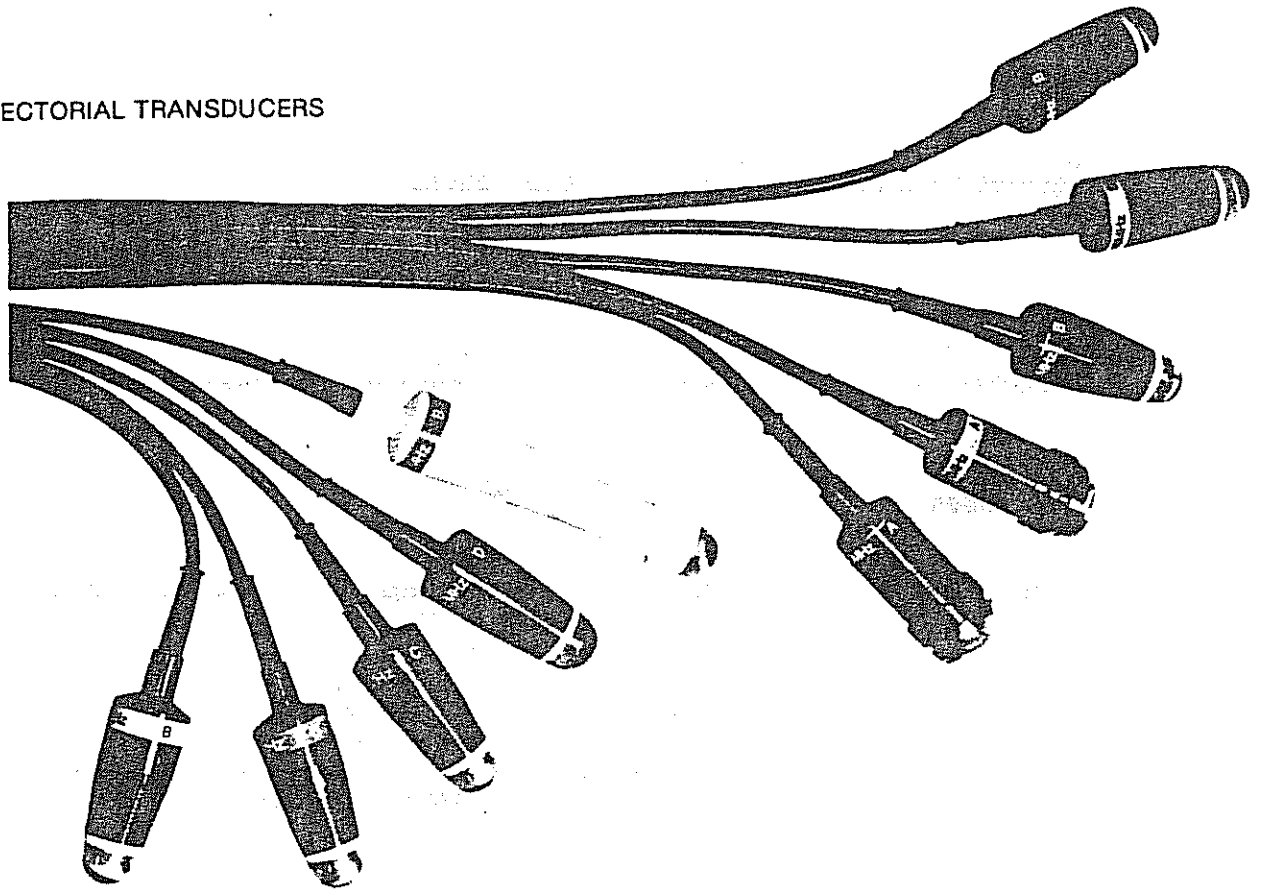

LINEAR TRANSDUCERS

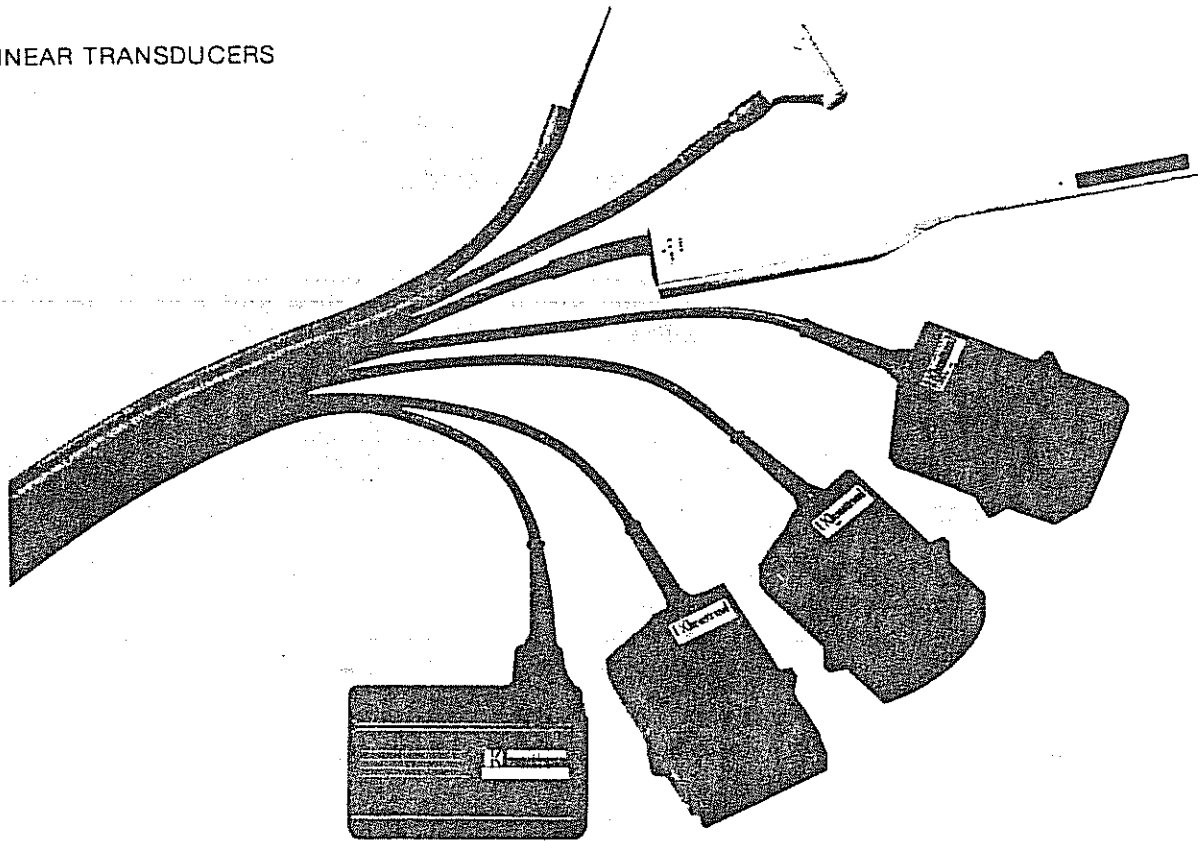

Figure 1-4 Sigma 1 AC transducer types

1.2 Functional description

The Sigma 1 AC system is intended for ultrasonic scanning in cardiovascular, gynecology/obstetrics and internal medicine applications.

Depending on the application, the best results are obtained by using the appropriate transducer. For selection of the proper transducer for each application please refer back to the description of transducers in section 1.1.2.

The Sigma 1 AC operational modes are two-dimensional (2D), time-motion (TM), and combined 2D/TM. The criteria for mode selection are given in the following table.

Operational modes

Two-Dimensional (2D)

Real-time two-dimensional image acquisition from the mechanical sector. The acquired image can be frozen by front panel control or footswitch operation. A zoom feature allows the operator to expand the image scale (two time original) and to position a zoom window on any area of the acquisition for detailed study. Image acquisition can be triggered from an ECG trace, with one or two markers, to display one or two synchronized images on the screen.

Time-Motion (TM)

The TM mode combines 2D imaging and time motion study. The motion line is positioned over the area of the 2D image to be studied and echoes, from surfaces under the motion line, are displayed on a scrolling trace. A zoom feature allows expansion of the time scale.

Combined (2D/TM)

The 2D/TM mode provides a simultaneous (side-by-side) display of the TM study and the 2D acquisition on which the study is based. The 2D display is automatically updated in this mode.

Cine Mode

Cine Mode allows to store and display the last twelve images acquired in real time and display them in review either step-by-step or like a movie.

1.3 Sigma 1 AC medical applications

A summary of medical application follows in paragraph 1.3.1, 1.3.2 and 1.3.3.

1.3.1 Cardiology

Sigma 1 AC cardiological scanning is suitable for :

Cardiac valves : mitral, aortic, tricuspidal and pulmonary.

Cardiac cavities.

Main cardiac vessels.

Periferal vessels

1.3.2 Gynecology / Obstetrics

Sigma 1 AC gynecological and obstetrical scanning is suitable for :

Uterine and auxillary pathology : uterus bicornis, retroverted uterus and ovarian cysts.

The study of Intrauterine masses and their relationship to the different components of the least pelvis.

Monitoring the positioning of the Intrauterine devices.

Post-operative patient monitoring following least pelvic surgery (lyphocyst, abscess, hematoma).

All obstetric monitoring such as fetal cardiography, fetal development and fetal monitoring.

Prenatal measurements.

1.3.3 Internal medicine

The Sigma 1 AC system is very useful for morphological studies of the main abdominal organs and vessels.

The Sigma 1 AC real-time acquisition has contributed significantly to the identification of these structures, as demonstrated in these examples :

| | |
|----------------------------|---|
| Liver | metastatis, hydatid, abscess, heptomegalla and cirrhosis. |
| Vesicle and biliary tracts | lithiasis, and cancer of the vesicle. |
| Pancreas | pseudocysts, and cancer of the pancreas. |
| Spleen | splenomegalia. |
| Prevertebral vessel | aneurysm of the aorta, aortal dissection and atheroma. |
| Kidneys | renal cysts, cancer of the kidney, hematoma, hydronephrosis and pyonephrosis. |

1.4 Configuration recognition

The software is able to recognize the configuration of your Sigma 1 AC. According to the Sigma 1 type, the following functions are enabled or disabled :

Sector module,
ECG module,
Linear module,
OB/GYN and internal medicine function.
Annular Array module
External Doppler module

At the switching on, the Sigma 1 AC type is displayed in a "welcome message".

1.5 Table of different Sigma 1 AC types

| FUNCTION | NAME | | | |
|--|--------------------|----------------------|---------------------|-----------|
| | Sigma 1 AC STAR | Sigma 1 AC CARDIO | Sigma 1 AC CLASS | Sigma 1 L |
| SECTOR | ♦ | ♦ | ♦ | o |
| ECG ⁴ | o | ♦ | o | |
| LINEAR | o | o | ♦ | ♦ |
| ANNULAR ARRAY MODULE | o ¹ | o ² | o ³ | |
| OB/GYN AND INTERNAL MEDICINE SOFTWARE | ♦ | o | ♦ | ♦ |

1 Upgradable to Sigma 1 AC ANNULAR S

2 Upgradable to Sigma 1 AC ANNULAR C

3 Upgradable to Sigma 1 AC ANNULAR LS

4 The ECG module enables, when connected, the cardiac functions

♦ : Implemented

o : optional

1.6 Table of different Sigma 1 AC ANNULAR types

| Function | Name | | |
|--|-------------------------|-------------------------|--------------------------|
| | Sigma 1 AC ANNULAR S | Sigma 1 AC ANNULAR C | Sigma 1 AC ANNULAR LS |
| SECTOR | ♦ | ♦ | ♦ |
| ANNULAR ARRAY MODULE | ♦ | ♦ | ♦ |
| LINEAR | o | o | ♦ |
| ECG ¹ | o | ♦ | o |
| OB/GYN and INTERNAL MEDICINE SOFTWARE | ♦ | o | ♦ |

1 The ECG module enables, when connected, the cardiac functions

♦ : Implemented

o : optional

2. CONTROL, INDICATOR AND CONNECTORS

2.1 Sigma 1 AC front panels

The upper panels (See Figure 2-1, items ① through ②②) contain :

| | |
|------------------------|-----------------|
| Multifunction softkeys | (section 2.1.1) |
| Alphanumeric keyboard | (section 2.1.2) |
| Function keys | (section 2.1.3) |
| Trackball | (section 2.1.4) |
| Adjustment controls | (section 2.1.5) |

The lower panel (Figure 2-1, items ②③ through ③①) contains :

| | |
|----------------------------|-----------------|
| Adjustment control | (section 2.1.5) |
| Power indicator | (section 2.1.5) |
| Transducer connector ports | (section 2.1.6) |

The alphanumeric keys, function keys and softkeys are all touchkeys supplied on a membrane keyboard. The ON/OFF switch is a push-button (push-ON, push-OFF) that displays a green faceplate when pressed to the ON position. The trackball is a multi-direction monitor screen cursor positioning device. Adjustment controls are of a vernier (sliding) type or knurled knob potentiometer (turn clockwise to increase, counterclockwise to decrease) type. The connector ports are specific receptacles for matching with the designated equipment connectors.

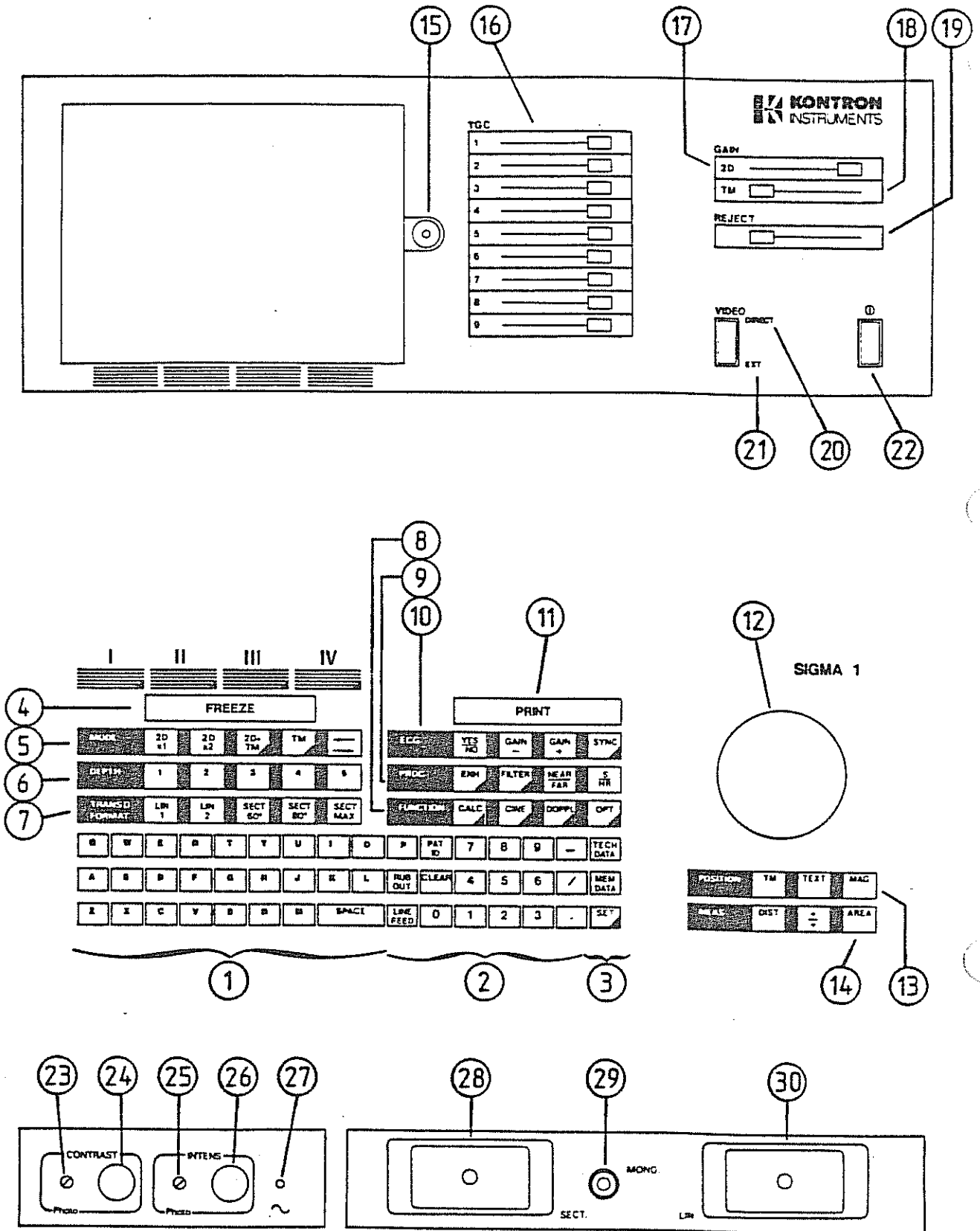

Figure 2-1 Front panels

KEYS FOR FIGURE 2-1

- | | | |
|---|-----------------------------|---|
| ① | | |
| ② | ALPHANUMERIC KEYBOARD | |
| ③ | | |
| ④ | FREEZE | : allows image freeze and defreeze commands |
| ⑤ | MODE | : (2D x 1, 2D x 2, 2D + TM, TM) |
| ⑥ | DEPTH | : (1, 2, 3, 4, 5) |
| ⑦ | TRANSD FORMAT | : (LIN 1, LIN 2, SECT 60°, SECT 80°, SECT MAX) |
| ⑧ | FUNCTIONS | : (CALC, CINE, DOPPL, OPT) |
| ⑨ | PROC | : processing commands |
| ⑩ | ECG | : (YES/NO, GAIN - , GAIN +, SYNC) |
| ⑪ | PRINT | : allows image hard copy command |
| ⑫ | TRACKBALL | |
| ⑬ | POSITION | : (TM, TEXT, MAG) |
| ⑭ | MEAS | : measurement (See sections 3 and 4) |
| ⑮ | POLAROID ADAPTER | : (contrast/intensity) |
| ⑯ | TGC | : Slope of gain compensation (9 vernier controls corresponding to 9 depth regions of the image) affecting the displayed image (2D and TM). |
| ⑰ | OVER-ALL GAIN FOR 2D IMAGES | : adjust 2D mode image display with the vernier control (slider). |
| ⑱ | OVER-ALL GAIN FOR TM IMAGES | : adjust TM mode image display with the vernier control (slider). |
| ⑲ | REJECT | : This rectilinear potentiometer controls the dynamic range of the ultrasound echoes that are displayed on the screen. ("NORMAL" position is on the extreme left). Move toward right to suppress weak echoes and increase display contrast. |
| ⑳ | VIDEO DIRECT | : allows direct display of the echoes on the monitor screen. |
| ㉑ | VIDEO EXT | : allows external video tape reading via a video tape recorder (optional). |
| ㉒ | POWER ON/OFF | : "ON" condition switch-indicator is green. |
| ㉓ | CONTRAST | : Photo adjustment for the Polaroid camera transmitted to ⑮, Polaroid adapter. |

- | | | |
|----|-----------------|--|
| ②4 | CONTRAST | : Adjustment for the screen image contrast during the examination. |
| ②5 | INTENSITY | : Photo adjustment for the Polaroid camera, transmitted to ①5, Polaroid adapter. |
| ②6 | INTENSITY | : Adjustment for the screen image intensity during the examination. |
| ②7 | Power indicator | : Illuminated when power is applied to the unit. |
| ②8 | SECT | : Connector port for a sectorial transducer. |
| ②9 | MONO | : Connector for a single-crystal transducer. |
| ③0 | LIN | : Connector port for a linear transducer. |

2.1.1 Multifunction softkeys

The softkey, located in front of the monitor screen, are multifunction selection keys that are used in different application and in combination with other function keys..

To select a function from the screen display, touch the appropriate Multifunction Softkey that is directly below the desired selection. As an example :

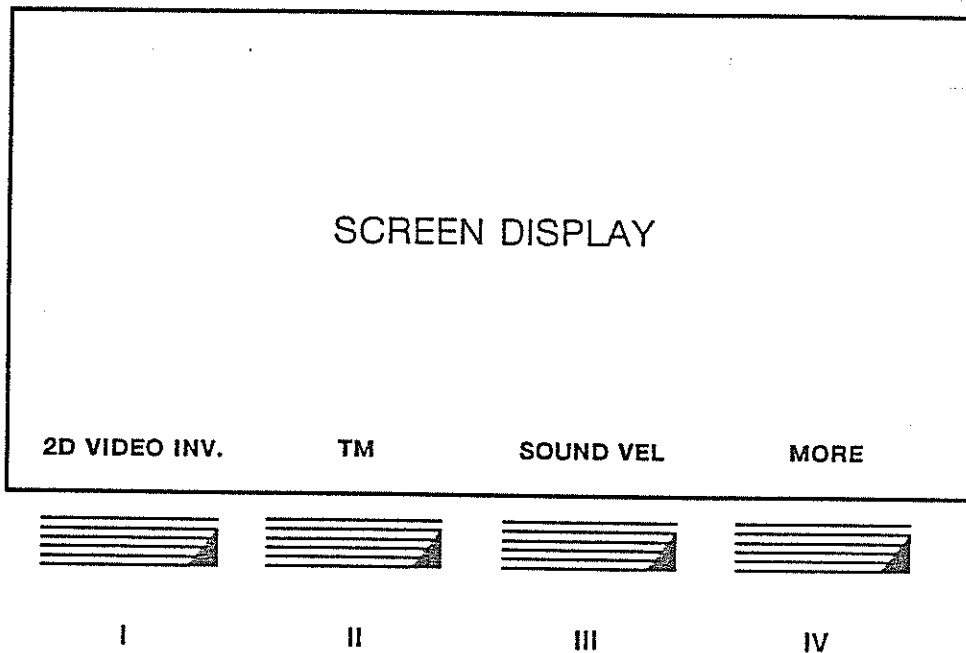

Touching  allows the video inversion (white or black).

The other function keys that softkeys I, II, III, and IV are with area coded as shown .

2.1.2 Alphanumeric keyboard

The letters and numerals of the keyboard (Figure 2-1. Items ① and ②) allows the user to formulate and enter patient and examination data.

The dedicated function keys (Figure 2-1, Items ① , ② and ③) are described as follows :

RUB
OUT

Letter by letter text erasing.

LINE
FEED

Go to a new line. In biometry programs, the **LINE FEED** key has also the function of an **ENTER** key.

PAT
ID

Patient identification. Used to enter new patient identification data (together with the **SET** key), remove old data, and recall patient identification data to the screen.

CLEAR

Clear the non-permanent text on the screen.

Note

When the user selects a new probe, the "Patient Identification Data" disappears. Then, press the "PAT ID" key to recall this data.



With SET , the following functions are available :



Program personal parameters, such as different setups, the power-up-setup, the sound velocity, the video polarity and the clock/calendar.



Enter permanent text.



Enter patient name.



Set TM-Speed and select Mono-Channel-Transducer.



Switch the biopsy line on.



Select the default "Entry-Point" into CALC package (to directly enter inside the function when the CALC key is pressed).



Reset Sigma 1 AC to the "Init-Mode".



Display the self-test menu.



Display Software Version Number.

2.1.3 Function Keys

The function keys (Figure 2-1, Items ④ through ⑪, ⑬ and ⑭) have the following functional characteristics :



Touch to freeze the image ; touch again to defreeze.



This key set allows to choose the visualization of the 5 different modes :

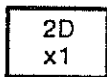

Touch to select 2D single-image display.

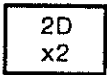

Touch to select 2D two-image (side-by-side) display.
Touch to display and vice versa.



Touch to select 2D/TM combination (side-by-side) display. In sector mode the 2D image is frozen as the motion study is completed. Touch this key again and the image is reversed. Touch this key again and the image freeze is reversed; touch again to return to the original mode display type. In linear mode, the 2D and TM images are scanned simultaneously.



Touch to select TM single-image display. Time-depth markers are displayed on the TM picture.



Touch for image inversion (left-right).

DEPTH

This key set allows to choose 5 different depths :

1

Touch to select a depth of :

8 cm for 3.5 MHz transducers.
6 cm for 3.5 MHz AA transducer.
6 cm for higher frequency transducers.

2

Touch to select a depth of :

10 cm for 3.5 MHz transducers.
8 cm for higher frequency transducers.

3

Touch to select a depth of :

13 cm for 3.5 MHz transducers.
10 cm for higher frequency transducers and 3.5 MHz AA transducer.

4

Touch to select a depth of :

18 cm for 3.5 MHz transducers.
13 cm for higher frequency transducers and 3.5 MHz AA transducer.

5

Touch to select a depth of :

23 cm for 3.5 MHz and 3.5 MHz AA transducers.
18 cm for higher frequency transducers.

TRANSO
FORMAT

LIN
1

Touch this key to initiate the use of a linear or a curved linear transducer.

LIN
2

Touch this key to initiate the use of a second linear transducer (Linear switch-box mandatory).

SECT
60°

Touch to select a 60 degree angle transducer sweep (sectorial transducer only).

SECT
80°

Touch to select an 80 degree angle transducer sweep (sectorial transducer only).

SECT
MAX

Touch to select a maximum angle transducer sweep. For the cardiology (sectorial 3.5 MHz, C type) transducer MAX = 90 degrees. For A and B type transducer, MAX = 90 degrees in Survey Mode and MAX = 105 degrees in High Resolution Mode.

FUNCTION

CALC

Touch to access biometry functions (choices displayed in four screen positions selectable from Multifunction Softkeys I, II, III, IV). See section 2.1.1 "Multifunction softkeys" and section 4.

CINE

Touch to select Cine Loop.

DOPPL

Touch to access Doppler functions if the Doppler module is connected to the system.

OPT

To be defined.

A rectangular button with a stippled background and the text "PRGC" in the center.A rectangular button with a white background and a black border, containing the text "ENH".

Image enhancement functions.

A rectangular button with a white background and a black border, containing the text "FILTER".

Image filtering functions. See paragraph 2.1.3.1. "Using processing keys".

A rectangular button with a white background and a black border, containing the text "NEAR" above "FAR".

Select optimal processing for near or far zone respectively.

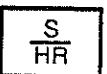
A rectangular button with a white background and a black border, containing the text "S" above "HR".

Touch to select S (Survey) or HR (High Resolution) mode.

A rectangular button with a stippled background and the text "ECG" in the center.

(When ECG kit is installed)

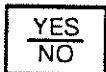
A rectangular button with a white background and a black border, containing the text "YES" above "NO".

Touch for **YES**: ECG plot is displayed on the monitor screen.
Touch for **NO**: ECG plot is not displayed on the monitor screen.

A rectangular button with a white background and a black border, containing the text "GAIN" above "-".

Touch to decrease ECG gain.

A rectangular button with a white background and a black border, containing the text "GAIN" above "+".

Touch to increase ECG gain.

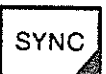
A rectangular button with a white background and a black border, containing the text "SYNC".

Touch to synchronize the 2D image with the ECG cycle.

PRINT

Touch to request a hard copy of the screen image.

POSITION

TM

Touch to obtain a TM study line over a 2D acquisition image. Touch again to suppress it.

TEXT

Touch to access the next entry mode.

MAG

Touch to magnify (enlarge) the image display. Touch again to return to normal image display.

MEAS

DIST

Touch to start distance measurement.

$\frac{+}{+}$

Touch to select an other cross.

AREA

Touch to make area and circumference measurements.

2.1.3.1 Using processing keys

To use the processing functions, touch **ENH** : this sets up multifunctions softkeys I, II, III and IV to make selections from the preprocessing and postprocessing functions that are displayed on the screen.

Softkeys I and II are used for preprocessing functions and Softkeys III and IV are used for postprocessing functions.

2.1.3.1.1 Preprocessing

There are seven preprocessing ENHANCE functions available, each selected by the appropriate Softkey (I or II).

These functions are :

| | |
|----------------------------|--|
| ENH 0 | No enhancement applied to the image |
| ENH +1 ENH +2 ENH +3 | Increasing contour enhancement by non linear peaking without compression of the greyscale. Optimized for contrasted images (such as cardiology). (Especially in TM mode). |
| ENH -1 ENH -2 ENH -3 | Increasing contour enhancement by non linear peaking with compression of the greyscale and automatic gain control. Optimized for smooth images (such as those with very large dynamic range) for optimal viewing of parenchymal structures. |

Suggested ENHANCE applications :

| Imaging mode | Enhance value |
|--------------|---|
| 2D | ENH 0 for cardiology ENH -2 for abdominal ENH +2 for vascular |
| TM | ENH +3 |

These seven ENHANCE steps guarantee quality of imaging without compromise for cardiac, vascular, small part or abdominal scanning.

2.1.3.1.2 Postprocessing

Postprocessing POST 1, POST 2, POST 3 and POST 4 (selected by Softkeys III and IV) access four postprocessing curves.

These dedicated, separately optimized, postprocessing curves are used for 2D and TM imaging white on black and black on white displays.

| White on black pictures | | Black on white pictures | |
|-------------------------|--|-------------------------|----------------------------------|
| POST 1 to POST 4 | give increasingly bright, smooth and noise sensitive pictures. | POST 1 to POST 4 | increasingly contrasted picture. |
| POST 1 | contrasted, noise insensitive picture indented for cardiology and 5 MHz imaging. | POST 1 and POST 2 | good inverse TM |
| POST 3 | bright and smooth picture for 3.5 MHz imaging (cardio and abdo). | POST 4 | dedicated to abdominal imaging. |

2.1.3.1.2.1 Filter



This touchkey displays the multifunction Softkey Menu for Softkeys I and II.

With these two Softkeys, you can step through the entire set of digital frame filters.

Sigma 1 AC feature a unique image processing digital filter system :

Permanent beam-to-beam filter to improve image smoothness and reduce noise level.

Four-step frame filter for increased signal/noise ratio and image quality enhancement.

Frame filters characteristics are :

| | |
|----------------|---|
| F1 F2 F3 | Non-linear, signal-adaptive noise reduction filters with increasing noise reduction factors. These filters are the digital equivalent of CRT remanence. By superimposing a few pictures, the noise appears less aggressive and the image is steadier. For fast-moving images, the number of superimposed images must not be too large, or they will moving pictures. Filter 3, with a very large time constant, gives excellent results in the SYNC mode. |
| F4 | Unique non-linear signal-adaptive movement enhancement filter. It allows greatly improved imaging of moving structures (heart valves and walls) in difficult-to-scan patients. In Radar terminology it is called MTI for Moving Target Indicator. |
| F0 | Without filter : suggested for standard cardiology. |

Shortly said :

| | |
|----------|---|
| Filter 0 | No frame filter for cardiology |
| Filter 1 | Weak frame filter for cardiology |
| Filter 2 | Medium frame filter for abdominal |
| Filter 3 | Strong frame filter for abdominal and ECG-SYNC-MODE |
| Filter 4 | Movement enhancement for cardiology |

2.1.3.1.2.2 Near/Far



This touchkey works as a toggle switch and selects an image processing which is optimized for the region of most interest at the top (NEAR) or at the bottom (FAR) of the image. If the Annular Array module is implemented, this touchkey, according to the chosen depth, set the focal point in transmission. The position of the focal points is located at 1/3 and 2/3 of each selected depth.

2.1.3.1.2.3 Image generation techniques

In order to make full use of the very high bandwidths of the Sigma 1 AC scanheads, the following techniques are used :

Optimum Transmission Frequency is determined and controlled by the Sigma 1 AC computer for each image format. For instance, up to 10.5 MHz is used for imaging of limited depth (that is 6, 8 cm and 10 cm formats), as well as with 3.5 MHz transducers.

In near mode (optimized for the highest resolution) the Transmission Frequencies used are higher than in FAR mode. Different Transmission Frequencies are used for 2D and TM imaging. The best choice have been carefully optimized during extensive clinical trials.

The transmit focus is optimized for each mode (NEAR/FAR, DEPTH) when the Annular Array module is implemented.

The dynamic focusing at the reception is divided into 13 zones (6 zones with dynamic aperture). These features give the following advantages :

- High definition of large aperture transducers
- High definition of large aperture transducers in proximal zone thanks to the dynamic aperture.

The receiver has a built-in tracking filter. This dynamically-variable filter adapts to the center-frequency shift displayed by an ultrasound burst propagating in the body. As depicted in the tracking filter figure, the spectrum of the echoes coming back

The received spectrum is shifted, however, to lower frequencies at increasing depths. This frequency shift is compensated by the adapted tracking filter.

The Sigma 1 AC tracking filter is fully computer-controlled and has been separately optimized for each transducer, NEAR/FAR mode, 2D/TM mode and DEPTH.

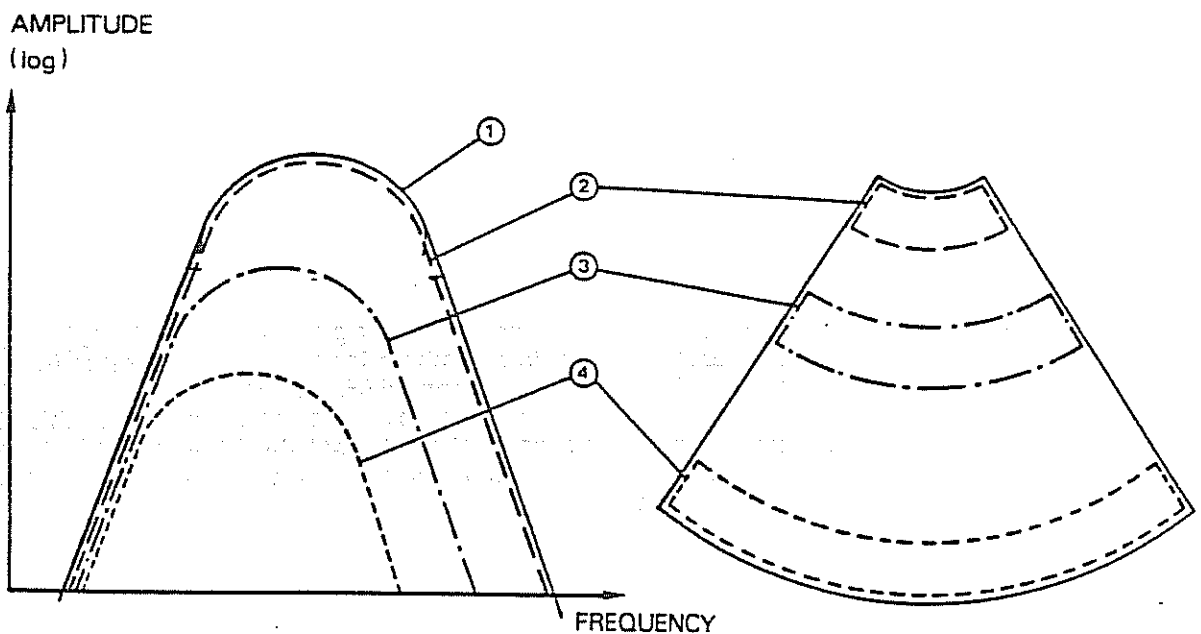

TRANSMITTED AND RECEIVED SIGNAL

SECTOR IMAGE

- ① ——— transmitted spectrum
- ② - - - - - echo spectrum received from image top
- ③ - . - . - echo spectrum from the middle of the image
- ④ echo spectrum from image bottom

2.1.3.2 Using the position keys

POSITION

TM

When this key is touched, the TM line is positioned over the area of the 2D image to be studied.

To remove the TM line from the 2D image, touch this key again.

To move the TM line, use the **TRACKBALL**.

By freezing the image, it is possible to record a TM-image with a Line-Scan Recorder as long as the TM-line is visible.

TEXT

Touch this key to write non-permanent text in any location on the image, such as LV to mark the left ventricle.

Position the text cursor with the **TRACKBALL** or **SPACE** and **LINE FEED** keys.

Enter text from the alphanumeric keyboard.

Clear text by touching **CLEAR** or erase single characters using **RUB OUT**.

MAG

Touch this key to enlarge a live (Real-time) image or frozen image in memory.

Select the "zoom" area with the **TRACKBALL**.

Touch **MAG** again to return to the normal image.

2.1.3.3 Using measurement keys

2.1.3.3.1 2D Dual distance

1. In the 2D mode, press **DIST** . If the image was not frozen, this will freeze it.
2. A cross will appear at the upper-left corner of the screen. Move it with the **TRACKBALL** to the first point of the distance to be measured.
3. Touch **+/+** . the cross will blink.
4. Move the second cross with the **TRACKBALL** to the end point of the distance to be measured. The first cross will remain fixed. The exact distance between the two crosses will be displayed at the lower-right corner of the screen.
5. To measure a second distance, touch **+/+** and move the third cross which has now a different shape to the start point of the second distance to be measured.
6. Touch again **+/+** and move the fourth cross to the end point of the second distance. This distance will also be displayed on the bottom of the screen.
7. Touching again **+/+** erases the first pair of cross and you continue at point 5.
8. Exit this mode by either of the following methods :

Touch **DIST** or **AREA** or **TEXT** to exit the measurement mode. The image remains frozen and another measurement can be made.

Touch **FREEZE** to exit the measurement mode, defreeze the image, and return to normal operation.

Note

The second pair of crosses is only available in single image mode. In double image mode, only one distance per image can be measured.

2.1.3.3.2 2D area/circumference

1. In the 2D mode, touch **AREA** . If the image was not frozen, this will freeze it.
2. A cross will appear at the upper-left corner of the screen. Move it with the **TRACKBALL** to the start of the area and circumference measurement.
3. Touch **+/+** . The cross will blink.
4. Move the second cross with the **TRACKBALL** along the contour to be measured. Small dots show the path. To alter the measurement path, erase the last three dots by moving the **TRACKBALL** back. The interim result of the circumference measurement is displayed at the lower-corner of the screen.
5. To obtain the definitive result, close the dotted loop using the **TRACKBALL** . The crosses will disappear, and the exact area and circumference of the defined area will be displayed at the lower-right corner of the screen.
6. Exit this mode as described in step 6 of 2D-distance.

2.1.3.3.3 TM dual distance

1. In TM or 2D/TM mode, touch **DIST** . If the image was not frozen, the TM trace will be completed and then the image will be frozen.
2. A cross will appear in the upper-left corner of the screen. Move it with the **TRACKBALL** (in any direction) to the desired starting point of the distance to be measured.
3. Touch **+/+** . The cross will blink.
4. Move the second cross vertically to the end point of the distance to be measured. Distance D1 has been defined.
5. Touch **+/+** . The cross will blink.
6. Move the third cross (in any direction) to the starting point of the second measurement to be made.
7. Touch **+/+** . The cross will blink.
8. Move the fourth cross vertically to the end point of the second distance measurement. Distance D2 has been defined. The Sigma 1 AC computer then displays D1 and D2.
9. To measure another distance touch **+/+** again. The first and second crosses disappear. Continue with step 6.
10. Exit this mode at any time as described in step 6 of 2D-Distance.

Note

To measure the "shortening ratio", see section 3.4.3.



2.1.3.3.4 TM slope

1. In TM or 2D/TM mode, touch **CALC**, Multifunction Softkey II ("Slope"). If the image was not frozen, the TM trace will be completed and then the image will be frozen.
2. A cross will appear at the upper-left corner of the screen. Move it with the **TRACKBALL** to the start point of the desired slope.
3. Touch **+/+**. The cross will blink.
4. Move the second cross to the last point of the desired slope. The vertical distance, horizontal time, and their quotient, $S = D/T$, are displayed in the lower-right corner of the screen.

| Example of display | |
|--------------------|------------|
| D | 3.20 cm |
| T | 0.20 s |
| S | 16.00 cm/s |

5. Exit this mode as described in step 6 of 2D-Distance.

Note

- 1 Sound velocity is an important measurement parameter. It is programmed as follows:
 - 1  SET
 - 2  TECH DATA
 - 3 **SOUND VEL** (multifunction softkey III)
 - 4 Input (from the alphanumeric keyboard) the sound velocity value (normal value : 1540 m/s). Sigma 1 AC accepts this value within +/- 10%.
- 2 All measurements can also be performed in magifier mode. But note that they are only possible in the visible image field, i.e.: it is not possible to shift the zoom window during the measurement procedure

2.1.4 Trackball

The trackball (figure 2-1., Item (12)) provides quick and precise manipulation of the screen elements, as follows :

TM/Doppler dot line movement (if the Doppler module is connected to the system).

Text positioning.

Magnified (zoomed) area selection.

Distance measurements.

Area and circumference definition (with automatic lock-out).

2.1.5 Adjustment, controls and indicators

Controls and indicators (figure 2-1 , items (16) through (19) , and (23) through (27)) provide for the following adjustments and indications :

- (16) TGC : Adjust the slope of gain compensation level by positioning (move right or left) the nine vernier (sliding) controls until an even level is attained.
- (17) GAIN-2D : Adjust the gain for 2D images by positioning (move right or left) the vernier (sliding) control.
- (18) GAIN-TM : Adjust the gain for TM images by positioning (move right or left) the vernier (sliding) control.
- (19) REJECT : Adjust the dynamics of the ultrasound echo by positioning (right or left) the vernier (sliding) control. Move toward the right, weak echoes are suppressed and image contrast is increased.
- (23) CONTRAST : This polaroid camera photo contrast adjustment is pre-set and should not required readjustment. If the photo contrast exceeds or fails to meet normally acceptable limits, adjustment should be made by a service technician.
- (24) CONTRAST-Photo : Adjust the screen contrast by turning the knob clockwise or counter-clockwise, as required, to obtain the desired contrast level. This adjustment should be made at onset of Sigma 1 AC use. See paragraph 3.1.
- (25) INTENS-Photo : This polaroid camera photo-intensity adjustment is pre-set and should not require readjustment. If the photo intensity exceeds or fails to meet normally acceptable limits, adjustments should be made by a service technician.
- (26) INTENS : Adjust the screen intensity by turning the knob clockwise or counter-clockwise, as required, to obtain the desired intensity level. This adjustment should be made at onset of Sigma 1 AC use. See paragraph 3.1.
- (27) : Power-on indicator is illuminated (green) when power is applied.

2.1.6 Connectors

Connectors ports (figure 2-1, items ②⑧ , ②⑨ and ③①) provide receptacles for specific transducer connections :

- ②⑧ SECT : Connect sectorial transducer at this port.
- ②⑨ MONO : Connect the single-crystal transducer at this port.
- ③① LIN : Connect linear transducers at this port.

This page left blank

2.2 Sigma 1 AC rear panel

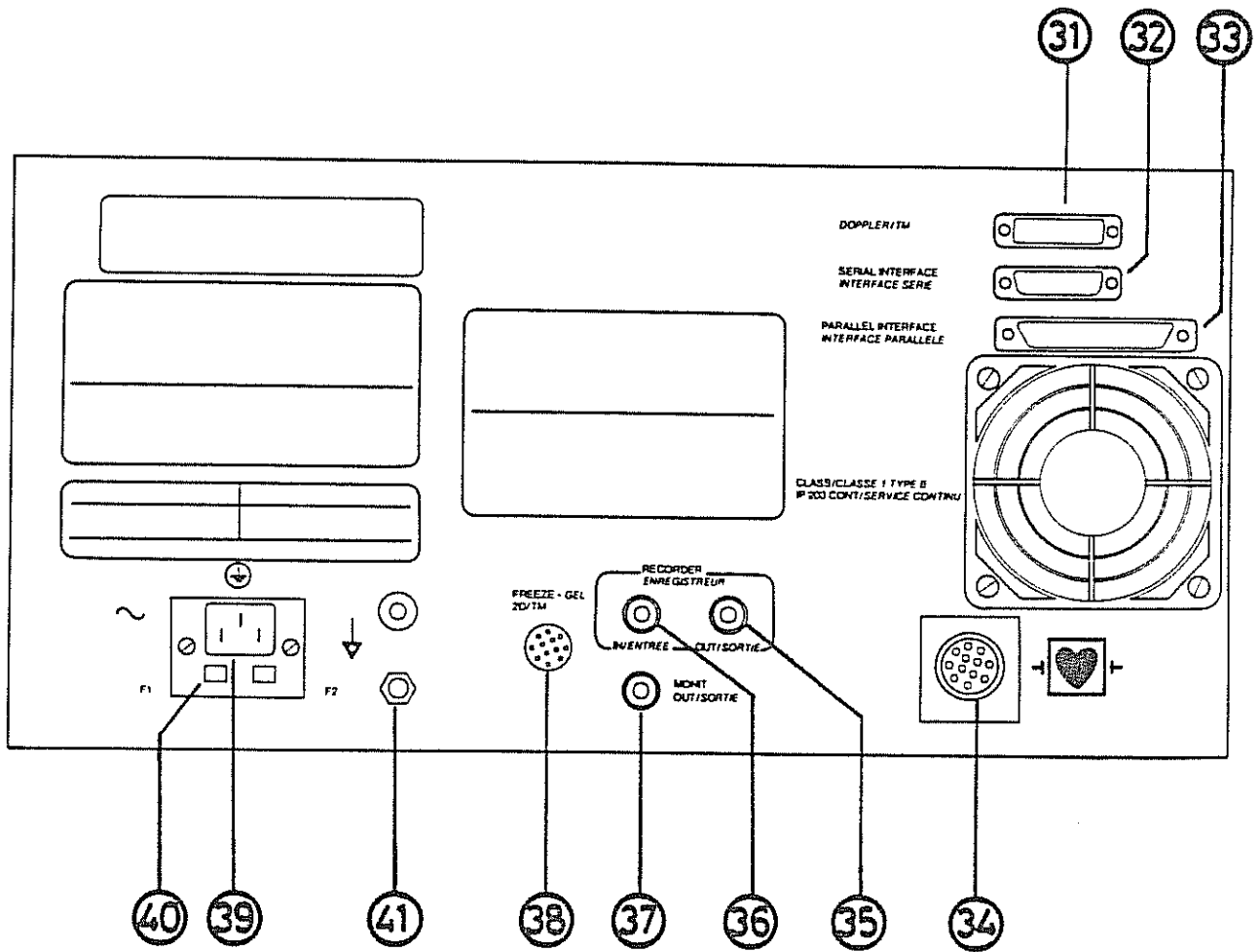

Figure 2-2. Rear panel

Keys for Figure 2-2

- ③1 DOPPLER/TM : LSR output
- ③2 SERIAL INTERFACE : (optional) Doppler connection
- ③3 PARALLEL INTERFACE : Optional equipment connection
- ③4 : ECG cable connector port
- ③5 RECORDER OUT : Video tape recorder output connector port
- ③6 RECORDER IN : Video tape recorder input connector port
- ③7 MONT. OUT : Monitor output connector port
- ③8 FREEZE - 2D/TM : Footswitch connector port
- ③9 : Unit power input connector port
- ④0 Fuses : Power surge / overpower protection
- ④1 GROUND : Male "multicontact" connector. (VDE standard female connector is available at KONTRON INSTRUMENTS S.A.)

3. OPERATION

3.1 Sigma 1 AC make-ready

3.1.1 Power supply

If the Sigma 1 AC is being plugged in for the first time, refer to Section 5-3.

If the Sigma 1 AC is in normal use but is being plugged into a power source (wall connection) at a new location, please make the following preliminary check :

- Supply voltage : ascertain that the power line supply voltage is the same as the line voltage specified on the Sigma 1 AC data plate (rear panel).
- Grounding : ascertain that the power source receptacle is a 3-pin socket with one grounded pin.

Note

The unit can be connected to the patient's bed by using the equalization potential terminal. See figure 2.2., item

④1 .

3.1.2 Polaroid camera

Observe that the camera and its attachment fittings are secure and that the camera swings freely into position in front of the image monitor screen on the front panel. For detailed information on loading and using the camera, refer to Section 5.2 .

3.1.3 Cables and connections

Check the connections of optional and auxiliary equipment, such as recorders (VTR, LSR), transducers and external monitor. Make sure that connections are properly and securely made and that cables and connectors are in normal condition :

Cable free of unnecessary stress or friction for the length of the cable.

Cable covering and insulation not cracked or broken.

Connectors secured at the cable end and matching securely at connection.

3.2 Initial procedures

3.2.1 Turn-on

Press the **ON/OFF** button (figure 2.1, item (22)) and observe that :

The green indicator shows on the **ON/OFF** button.

The power-on indicator (figure 2.1 , item (27)) illuminates (green).

A "welcome message" containing the configuration of your Sigma 1 AC is displayed for 5 seconds.

Press a letter or a number key to go earlier to normal operation.

Note

If during operation a key requiring a function not installed or in failure is pressed, a long beep will sound. The corresponding message is displayed:

L option not installed
Cardio option not installed
Sector option not installed

Note

To reset Sigma 1 AC at any time:



3.2.2 Personal parameters settings

3.2.2.1 General parameters

To allow Sigma 1 AC operation within a familiar framework, the following parameters can be stored in the permanent memory by two methods :

| | |
|------------------------|--------------------------------------|
| DEPTH | (same for 2D and TM) |
| ANGLE | |
| SURVEY/HIGH RESOLUTION | |
| NEAR/FAR | (same for 2D and TM) |
| POSTPROCESSING | (separate for 2D and TM) |
| IMAGE POLARITY | (B/W or W/B, separate for 2D and TM) |
| SCAN DIRECTION | (R → L or L → R) |
| DIGITAL FILTER | (2D only) |
| TM-SPEED | (TM or 2D + TM) |
| ENTRY-POINT | (for calculation package) |

The first method stores the parameters which are used at power-up and after reset :

Program Sigma 1 AC with all parameters in 2D and TM which you want to store. Then touch **SET** + **TECH DATA** + **Multifunction Softkey IV** ("More") + **Multifunction Softkey I** ("Init").

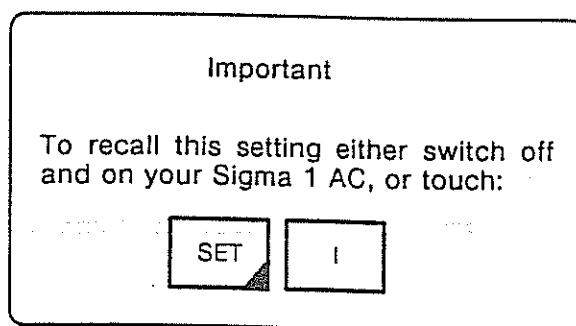

The second method allows you to store up to twelve different set-ups and recall them or eight factory-programmed set-ups :

These set-ups are different when using a sectorial or linear transducer, so six sectorial and six linear set-ups are available.

To store on of these set-ups, touch the following sequence : **SET + TECH DATA + Multifunction Softkey IV ("More") + Multifunction Softkey II ("Store set-up")**. Sigma 1 AC asks you to "Enter set number 4 - 9", and you answer by touching one of the number keys 4 - 9. Then, after having checked format and mode, your set-up is stored as set-up with this number.

The set-ups 0 to 3 cannot be programmed. To recall a set-up 0 to 9, select the desired transducer (note that the set-ups are different for linear and sectorial transducers) and touch **SET** and the number key of the desired set-up.

The factory-programmed set-ups contain settings for the following standard applications :

| SET UP | LINEAR | SECTORIAL |
|--------|-----------------------|-----------------------|
| 0 | Abdo | Cardio |
| 1 | Small-parts 5 MHz | Abdo |
| 2 | Small-parts 7.5 MHz | Small-parts |
| 3 | Abdo with B/W display | Abdo with B/W display |

To erase or recall the technical data display on the screen, touch **TECH DATA** .

3.2.2.2 Sound velocity

To temporarily program the sound velocity, touch **SET + TECH DATA + Multifunction Softkey III** (to access SOUND VEL), then enter the complete 4-digit number via the alphanumeric keyboard.

The system accepts the value of 1540 m/sec \pm 10 %. The microprocessor will only accept a value within these limits. The Sigma 1 AC microprocessor calculates the markers' distance on the automatic calibration.

3.2.2.3 Permanent clock/calendar

To program the permanent clock/calendar :

Touch **SET + TECH DATA + Multifunction Softkey IV ("More") + Multifunction Softkey III** ("Set clock").

Enter the current date in the form DD MM YY.

Enter the current time in the form HH MM SS.

At Sigma 1 AC turn-on, the system will start with the parameters stored in the protected memory.

It is possible to change any of these "personal" parameters during the examination.

3.2.3 Contrast and intensity adjustments

Adjust as required, the **CONTRAST** and **INTENS** knobs (figure 2-1, items (24) and (26)) located to the left of the transducer connections on the front panel under the keyboard, until an easily read image is obtained.

3.2.4 Transducer and patient preparation (for live image acquisition)

Coat the transducer scanhead, and the patient's skin area over the part of the body to be scanned, with gel.

3.3 Typical settings for 2D imaging

3.3.1 Mode selection

Note

If no transducer is connected to Sigma 1 AC at turn-on, it automatically selects the mono-channel transducer mode

After having connected one transducer, touch one of SECT keys to switch to the corresponding format or SET + I to reset the Sigma 1 AC.

3.3.2 Parameters selections

| PARAMETER | PROCEDURE |
|-----------|--|
| GAIN 2D | Adjust the overall gain by moving the vernier (sliding) control right or left to achieve the desired amplitude. |
| TGC | Adjust the 9 vernier (sliding) controls for an even image display gain level. If the screen darkens towards the top, adjust to increase the amplification of "NEAR" echoes". If the screen darkens towards the bottom, adjust to increase the amplification of "FAR" echoes. |
| REJECT | Adjust for optimal display contrast level. Moving the control to the right suppresses weak echoes and increases contrast. |

PARAMETER

PROCEDURE

ENH

Select enhancement. Seven image-quality enhancement are available by using the ENH touchkey and the Multifunction Softkeys I, II, III, IV.

The softkey functions are :

| | |
|-----|---------------------------------------|
| I | Touch to decrement ENH to - 2 and - 3 |
| II | Touch to increment ENH until + 3 |
| III | Touch to decrement PROC to 3, 2 and 1 |
| IV | Touch to increment PROC to 2, 3 and 4 |

Select ENH and PROC according to paragraph 2.1.3.1.1.

Refer to paragraph 2.1.3.1.1 : preprocessing description for details of the ENHANCE function.

FILTER

Select filter. Filter selection is decreased by touching Multifunction Softkey I, increased by II.

The filter options are displayed on the bottom of the screen and selected according to operator preference and automatic are under study.

Filter selection suggestions :

| | |
|----------|---------------------|
| F0 or F1 | standard cardiology |
| F1 or F3 | standard abdominal |

For detailed description of FILTERS, refer to paragraph 2.1.3.1.2.1.

NEAR
FAR

Select parameters optimized for best display at the top of the image ("NEAR") or at the bottom of the image ("FAR"). Normally, for best results, "NEAR" is recommended.

Note that this touchkey also acts on broad bandwidth transmission.

If the Annular Array module is implemented, this touchkey, according to the chosen depth, set the focal point in transmission. The position of the focal points is located at 1/3 and 2/3 of each selected depth.

TRANSD
FORMAT

Select transducer and in case of a sectorial transducer, select the sweep angle. The angle choices are selected by touchkeys SECT 60°, SECT 80°, and SECT MAX (90° or 105° with A or B type transducers and High Resolution mode). Select the desired sweep angle.

It should be noted that a large angle decreases the number of images per second.

The linear transducer selector works only with a linear switchbox.

PARAMETER

PROCEDURE

DEPTH

Select penetration depth. Penetration depth is selected by touchkeys 1 through 5.

| Touchkey | Depth with 3.5 MHz transducers | Depth with 5 MHz or 7.5 MHz transducers |
|----------|--------------------------------|---|
| 1 | 8 cm 6 cm for 3.5 AA | 6 cm |
| 2 | 10 cm | 8 cm |
| 3 | 13 cm | 10 cm |
| 4 | 18 cm | 13 cm |
| 5 | 23 cm | 18 cm |

It should be noted that greater depth decreases the number of images per second.

S
HR

Select **SURVEY** or **HIGH RESOLUTION** mode. Because the number of images per seconds on the transducer sweep angle and the penetration depth, the images per second in these modes is variable :

| Mode | Images per seconds |
|-----------------|--------------------|
| Survey | 12 to 30 |
| High resolution | 8 1/3 to 20 |

The mode is displayed in the status area shown in the upper- right screen area.

PAT
ID

Enter patient identification (name, address, age, etc.) data.

Press **SET** and **PAT ID**, then enter the patient identification data (37 characters maximum) via the alphanumeric keyboard.

Exit this mode with **LINE FEED** or **FREEZE**.

To erase ID data : press **PAT ID**.

To recall ID data : press **PAT ID** again.

It should be noted that patient ID data is cleared when Sigma 1 AC is turned off or when **SET + 1** is executed.

PARAMETER

PROCEDURE



To erase the tech data display press **TECH DATA**.
 To recall the tech data display press **TECH DATA**.
 To change a parameter temporarily : just touch the appropriate key.
 To save a set of parameters as power-up reset-set press **SET + TECH DATA + Multifunction Softkey IV ("More") + Multifunction Softkey I ("Init")**.
 To reset Sigma 1 AC and thus to recall the power-up set press **SET + I** .
 To save a set of parameters as permanently available set-up for a specific application press **SET + TECH DATA + Multifunction Softkey IV ("More") + Multifunction Softkey II ("Store setup") + N** , where N = 4 ... 9.
 To recall a specific set-up press **SET + N** , where N = 0 ... 9.
 The set-ups 0, 1, 2, 3, are fixed programmed and cannot be changed by STORE SETUP. They contain parameters for some typical applications.

| Set up | Sectorial application | Linear application |
|--------|-----------------------|---------------------|
| 0 | Cardio | Abdo |
| 1 | Abdo | Small parts 5 MHz |
| 2 | Small parts | Small parts 7.5 MHz |
| 3 | Abdo B/W | Abdo B/W |

At every set-up number actually there are two set-ups : 1 for linear and 1 for sectorial.



Touch **SET** , then position the cursor with the **TRACKBALL** at the beginning of the text for memorization and touch **MEM DATA**.
 Enter the text (32 characters maximum) via the alphanumeric keyboard.
 For a new line press **LINE FEED**.
 To skip a line press **LINE FEED + SPACE + LINE FEED** .
 To correct errors press **RUB OUT** (in current line) .
 To put data into memory press **LINE FEED LINE FEED** (twice).
 To clear data from memory press **SET + MEM DATA + LINE FEED** .
 At Sigma 1 AC turn-on, the last entered and memorized text is displayed.
 To erase permanent from display text press **MEM DATA**.
 To redisplay text press **MEM DATA** (again) .

PARAMETER

PROCEDURE

MAG

Select and deselect magnification (turn it on and off) by toggling (touch and touch again) the MAG key.

Position the magnified area with the TRACKBALL .

FREEZE

Freeze or defreeze (turn FREEZE on or off) by toggling (touch and touch again) this key or the footswitch that works in the same way.

An arrow in the lower-left of the screen indicates whether FREEZE is on or off :



FREEZE off



FREEZE on

Important

The 2D sectorial picture is automatically frozen 15 minutes after the last key stroke

2D VIDEO INVERSION

Select by touching SET + TECH DATA + Multifunction Softkey 1 ("2D video inv").

2D
x2

Initiate with this key the double image mode. It is possible to have two completely independent images with different transducers and different scanning formats on one screen.

After first touching 2D x 2 , the image on the right half of the screen is shown. Touching again 2D x 2 freezes the right image and activates the left image. If this switch is done after a freeze, the left image remains frozen, otherwise it becomes live.

With a linear scanhead, it is possible to make a composed image with doubled width. Measurements and calculations are possible to make a composed image with double width. Measurements and calculations are possible in both images independently.

PARAMETER

PROCEDURE

| PARAMETER | PROCEDURE |
|---|--|
| ECG | Connect the ECG cable (see figure 2-2 , item (34)) |
| YES NO | YES : ECG plotting function is on NO : ECG plotting function is off. If YES, the ECG plot appears at the bottom of the screen. |
| GAIN + | Increase ECG gain (level). |
| GAIN - | Decrease the ECG gain (level). |
| SYNC | To synchronize the 2D image with the cardiac period. A marker will appear under the ECG signal. Move this marker by touching Multifunction Softkey I ("Left") or Softkey II ("Right") to the selected point (cardiac period moment -- systole or diastole). Each time the ECG signal crosses that marker point the 2D image appears. |
| 2D x2 or Softkey III ("SYNC I + II ") | To synchronize with two points of the cardiac period moment, two images appear (side-by-side) on the screen. Position the first marker (as described above) on the image at screen-left. Position the second marker on the image at screen right by touching Multifunction Softkey III ("Left") or Softkey IV ("Right"). |
| 2D x1 | To return to a single 2D non-synchronized screen image. |

Note

For an extended period of image processing in SYNC mode, use filter F3 to improve image quality.

If synchronization is not achieved, adjust the gain level (GAIN+ or GAIN-).

If synchronization is not achieved through gain level, check the position of the electrodes.

It is also possible to have a SYNC mode image in 2D x 2 mode.

PARAMETER

PROCEDURE

CINE

Switch to Cine-Mode. The image is scanned in real-time. Twelve images are always stored in the memory. When the image is frozen a ruler is displayed at the bottom of the screen. If an ECG is displayed simultaneously, the ruler shows exactly the correspondence between ECG and image. The image which is actually displayed is marked with a large point on the ruler. It is possible to switch from one image to another by pressing **Softkey I** ("Step back") or **II** ("Step forward") or by pressing **Softkey III** ("Run"). In this case, the images are displayed sequentially like a movie: the speed can be adjusted with the **Softkey I** and **II**.

If the Cine Mode Softkeys are overwritten, e.g. by an ENH command, they can be called back by pressing **CINE**.

In Cine mode, the following functions are disabled: Magnifier, TM line, Biopsy guide, Text on screen, Angles greater than 80°.

Go to section 3.6 for the Operating Instructions.

3.3.3 2D image measurements procedures

3.3.3.1 Distance

DIST

If the image was not frozen, entering the DIST measurement mode will freeze it.

1. A cross will appear at the upper-left corner of the screen. Move it with the TRACKBALL to the first point of the distance to be measured.
2. Touch **+/+** . The cross will blink.
3. Move the second cross with the TRACKBALL to the end point of the distance to be measured. The first cross will remain fixed. The exact distance between the two crosses will be displayed at the lower-right corner of the screen.
4. To measure a second distance, touch **+/+** and move the third cross which has now a different shape to the start point of the second distance to be measured.
5. Touch again **+/+** and move the fourth cross to the end point of the second distance. This distance will also be displayed on the bottom of the screen.
6. Touching again **+/+** erase the first pair of crosses and you continue at point 4.
7. Exit this mode by either of the following method :
 - . Touch **DIST** or **AREA** or **TEXT** . The image remains frozen and another measurement can be made (repeat steps 1 through 4).
 - . Touch **FREEZE** . The image will defreeze, and the system returns to normal operation.

3.3.3.2 Area/circumference

| |
|------|
| AREA |
|------|

If the image was not frozen, entering the AREA measurement mode will freeze it.

1. A cross will appear at the upper-left corner of the screen. Move it with the **TRACKBALL** to the start of the area and circumference measurement.
2. Touch **+/+** . The cross will blink.
3. Move the second cross with the **TRACKBALL** along the contour to be measured. Small dots show the path. To alter the measurement path erase the last three dots by moving the **TRACKBALL** back. The interim result of the circumference measurement is displayed at the lower-right corner of the screen.
4. To obtain the definitive result, close the dotted loop using the **TRACKBALL** .
5. The crosses will disappear, and the exact area and circumference of the defined area will be displayed at the lower-right corner of the screen.
6. Exit this mode as described in step 5 of "distance".

3.4 Typical settings for TM and 2D/TM imaging

3.4.1 Mode selection

Touch **TM** or **2D + TM**.

The **TM** footswitch is used to switch from **TM** to **2D** and back, or in **2D/TM** mode it acts like the **2D + TM** key.

3.4.2 Parameter selection

| PARAMETER | PROCEDURE |
|------------------|---|
| TM LINE POSITION | Position the TM line in the image with the TRACKBALL . |
| SPEED | <p>Touch SET + TM to set up Multifunction softkeys I, II, III and IV to access TM and 2D/TM speed.</p> <p>Touch Softkey IV to switch to the monochannel transducer.</p> <p>To switch back, touch one of the TRANSD FORMAT keys.</p> <p>Touch Softkey I, II and III to program movement speed.</p> |

DEPTH

Select penetration depth. Penetration depth is selected by touchkeys 1 through 5.

| Touchkey | Depth with 3.5 MHz transducers | Depth with 5 MHz or 7.5 MHz transducers |
|----------|--------------------------------|---|
| 1 | 8 cm 6 cm for 3.5 AA | 6 cm |
| 2 | 10 cm | 8 cm |
| 3 | 13 cm | 10 cm |
| 4 | 18 cm | 13 cm |
| 5 | 23 cm | 18 cm |

PARAMETER

PROCEDURE

GAIN - TM

Adjust the overall gain by moving the vernier (sliding) control right or left to achieve the desired amplitude.

TGC

Adjust the 9 vernier (sliding) controls for an even image display gain level.

If the screen darkens towards the top, adjust to increase the amplification of "NEAR" echoes.

If the screen darkens towards the bottom, adjust to increase the amplification of "FAR" echoes.

REJECT

Adjust for optimal display contrast level. Moving the control to the right suppresses weak echoes and increases contrast.

2D AND TM VIDEO INV.

Select by touching SET + TECH DATA + Multifunction Softkey I and II ("2D VID INV TM"). This causes the white on black image to reverse to black on white.

This operates in live image mode (VIDEO DIRECT) only and is independently programmed in the TM operation.

ENH

Select enhancement. Seven image-quality enhancement are available by using the ENH touchkey and the Multifunction Softkeys I, II, III, IV.

The softkey functions are :

| | |
|-----|--|
| I | Touch to decrement ENH to - 2 and - 3 |
| II | Touch to increment ENH until + 3 |
| III | Touch to decrement PROC to 3 , 2 and 1 |
| IV | Touch to increment PROC to 2 , 3 and 4 |

Select ENH and PROC according to paragraph 2.1.3.1.1 .

Refer to paragraph 2.1.3.1.1 : preprocessing description for details of the ENHANCE function.

PARAMETER

PROCEDURE

FILTER

In TM, no filter is available.

**NEAR
FAR**

Select parameters optimized for best display at the top of the image ("NEAR") or the bottom of the image ("FAR"). Normally, for best results, "NEAR" is recommended.

If the Annular Array module is implemented, this touchkey, according to the chosen depth, set the focal point in transmission. The position of the focal points is located at 1/3 and 2/3 of each selected depth.

MAG

Select and deselect magnification (turn it on and off) by toggling (touch and touch again) the **MAG** key.

Position the magnified area with the **TRACKBALL**.

GREYSCALE

Generation of a greyscale to adjust the LSR :

Touch **SET + T** to see a softkey menu :

"16 GREYSCALE ALL NORMAL DIRECT TM.Z"

Softkey II and IV are especially useful for a service technician.

16 GREYSCALE generates a greyscale on the screen and at the LSR-Output with 16 steps to adjust the LSR.

3.4.3 TM and 2D/TM image measurement procedures

3.4.3.1 Distances and ratio

| |
|------|
| DIST |
|------|

If the image was not frozen, entering the DIST measurement mode will freeze it.

If you want to have the "shortening ratio" displayed, start with :

| | |
|-----------------------------|--------------|
| CALC | |
| + Multifunction softkey III | ("Biometry") |
| + Multifunction softkey II | ("Cardio") |
| + Multifunction softkey I | ("Ratio") |

1. A cross will appear in the upper-left corner of the screen. Move it with the TRACKBALL (in any direction) to the desired starting point of the distance to be measured.
2. Touch +/+. The cross will blink.
3. Move the second cross vertically to the end point of the distance to be measured. Distance D1 has been defined.
4. Touch +/+. The cross will blink.
5. Move the third cross (in any direction) to the starting point of the second measurement to be made.
6. Touch +/+. The cross will blink.
7. Move the fourth cross vertically to the end point of the second distance measurement. Distance D2 has been defined.

The Sigma 1 AC computer then displays D1, D2 and if "ratio" was selected, a "shortening ratio" (in percent) defined as follows :

$$R = 100 \times (D_{\max} - D_{\min}) : D_{\max}$$

where D max is the minimum value of D1, D2 and Dmin is the minimum value.

Example of display :

```
D1 : 5.00 cm
D1 : 3.50 cm
R  : 30 %
```

8. To measure another ratio, touch +/+ again. The first and the second crosses disappear. Continue with step 5.
9. Exit this mode by either of the following methods :

Touch **DIST** or **AREA** or **TEXT**. The image remain frozen and another measurement can be made (repeat steps 1 through 9).

Touch **FREEZE** . The image will defreeze and the system returns to normal operation.

3.4.3.2 Slope

**+ Multifunction softkey II ("Slope")**

If the image was not frozen, the TM trace will be completed and then the image will be frozen.

1. A cross will appear at the upper-left corner of the screen. Move it with the TRACKBALL to the start point of the desired slope.
2. Touch +/+ . The cross will blink.
3. Move the second cross to the last point of the desired slope. The vertical distance, horizontal time, and their quotient, $S = D/T$, are displayed in the lower-right corner of the screen.

Example of display :

D : 3.20 cm
T : 0.20 s
S : 16.00 cm/s

4. Exit this mode as described in step 9 of distance and ratio.

3.5 Displays

The following displays illustrate and define the screen characteristics for scanning techniques described in this section.

The conventions used to annotate these illustrations are :

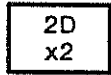

Keyboard control required to obtain the display illustrated.



Key to a specific display feature definition.

2D x2 2D x2 DIST $\frac{+}{+}$

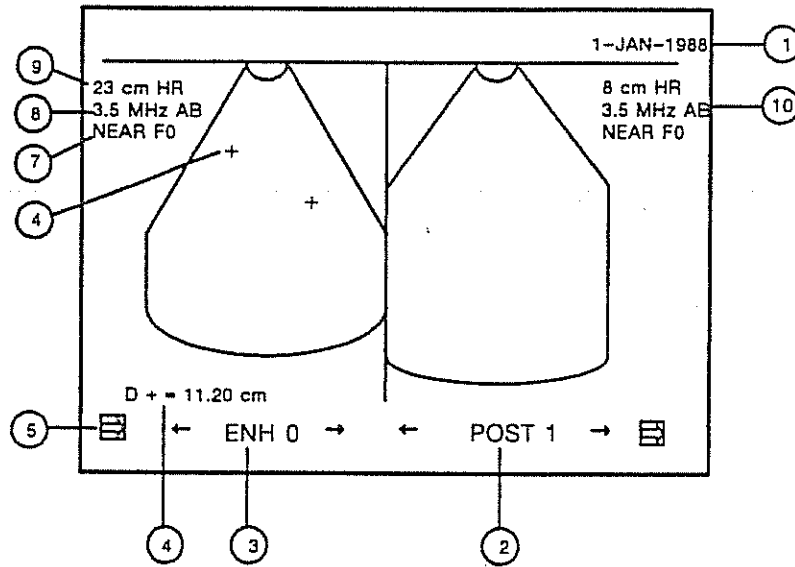

- ① Date
- ② POST 1= Postprocessing
- ③ ENH 0 = Enhancement 0
- ④ Measurement for distance marked with + shaped crosses
- ⑤ Freeze arrow (image frozen)
- ⑥ Measurement point
- ⑦ NEAR F0 (Filter 0)
- ⑧ 3.5 MHz AB (transducer)
- ⑨ 23 cm HR (Depth HIGH RESOLUTION)
- ⑩ 8 cm HR (Depth HIGH RESOLUTION)

2D x2 2D x2 DIST $\frac{+}{+}$

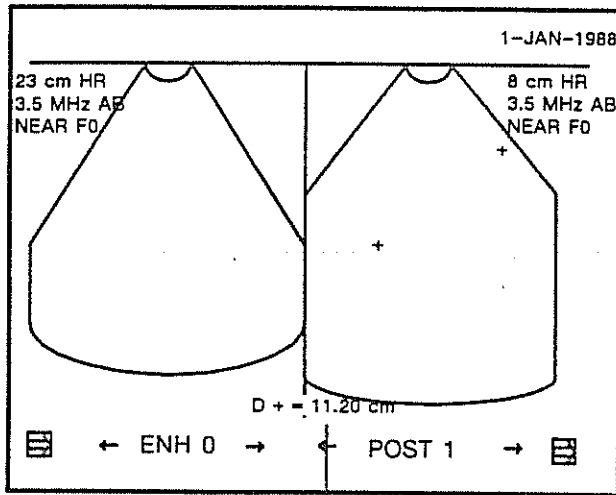

11

Measurement for distance marked with + shaped crosses

2D+
TM

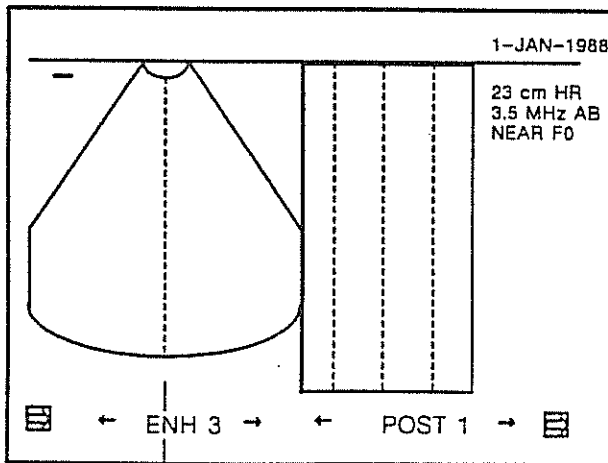

12

TM line

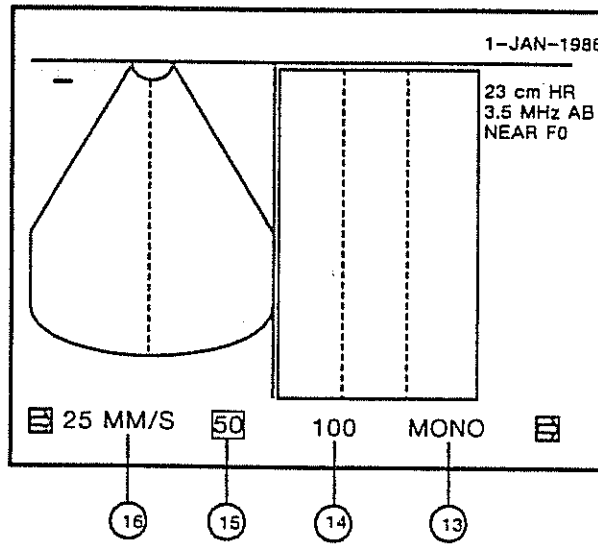

Background reverses for selected speed.

- ⑬ Select single-crystal transducer
- ⑭ TM speed selected by Softkey
- ⑮ TM speed selected by Softkey
- ⑯ TM speed (in mm/s).

TM

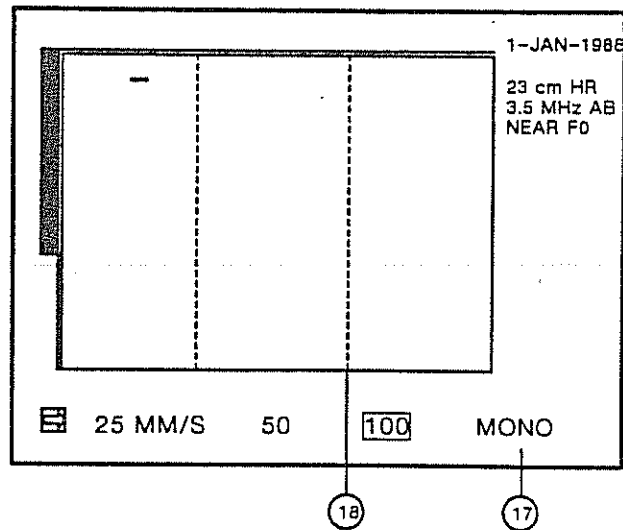

- ①7 SET + TM then Softkey IV to access mono mode.

Note

Return to sectorial or linear transducer with a LIN or SECT key.

- ①8 Time depth-markers.

Note

If a Sigma Doppler is connected to Sigma 1 AC and switched-on, the TM-image is displayed on the Doppler monitor. The Sigma 1 AC monitor still displays the 2D image.

ECG

YES
NO

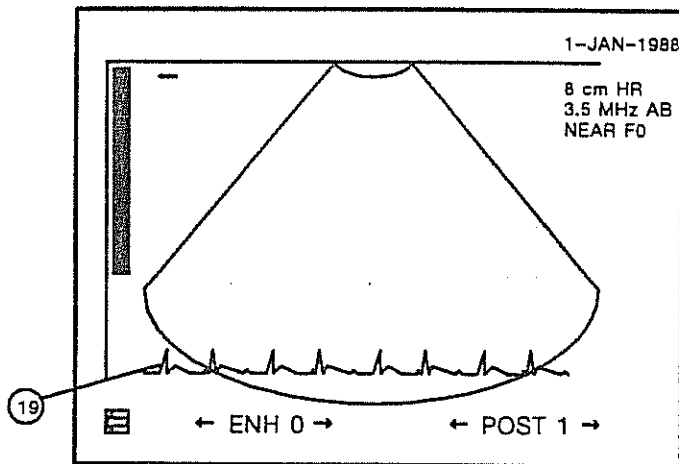

19

ECG Trace line.

SYNC

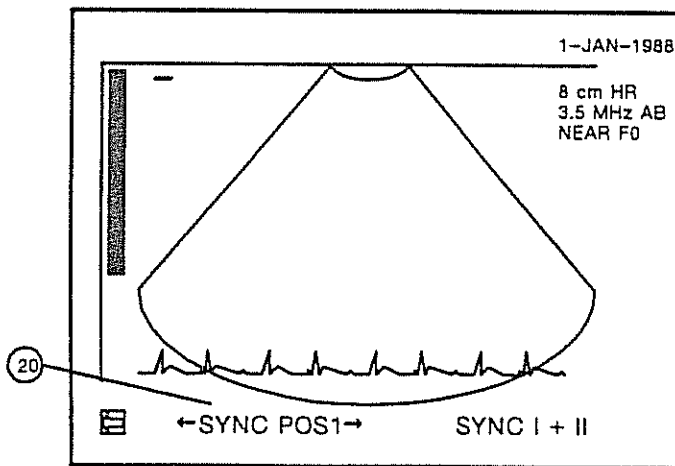

20

Synchronized mode indication.

2D.
x2

or Softkey " SYNC I + II "

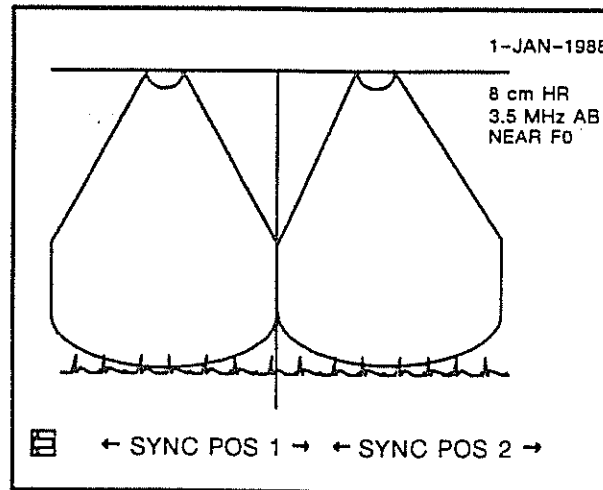

Produces two images, side by side with the synchronized trace across both images.



+ Multifunction Softkey " SYNC I "

The two pictures are independently synchronized.

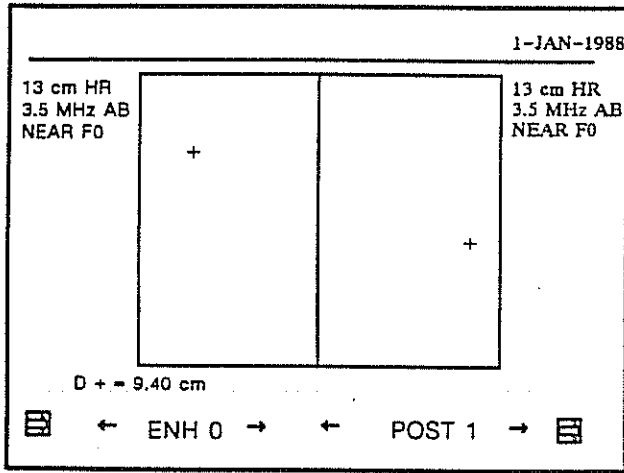

In this illustration the measurement is made across both images because the depth is the same on each image, in the instance 13 cm.

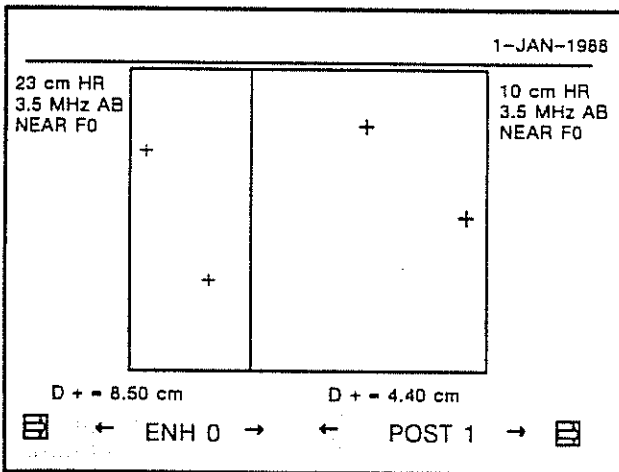

In this illustration the penetration depth is not the same for both images (in this instance 23 and 10 cm) so two distance measurements must be made.

2D
x1 LIN
 1

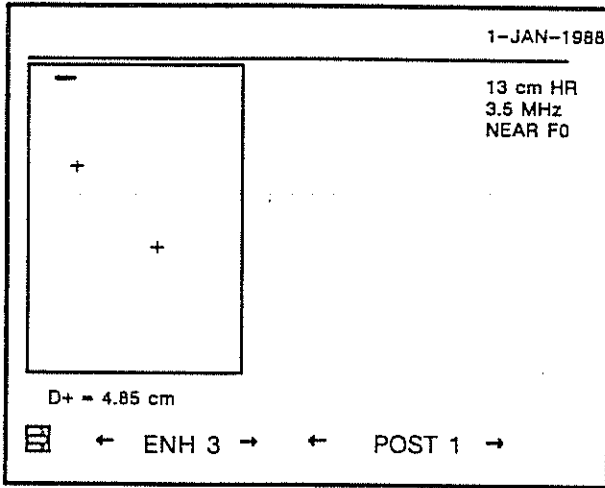

When linear and sectorial transducers are both connected, it is possible to activate linear transducer by pressing LIN 1. The transducer's corresponding will be displayed on the screen.

2D+
TM

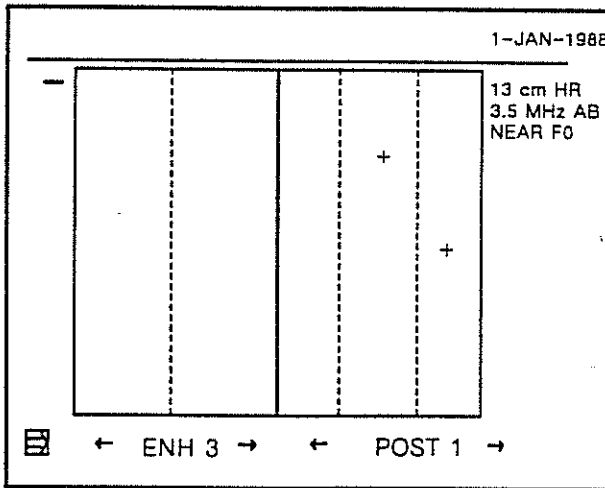

Slope measurement is possible on the TM image in this example.

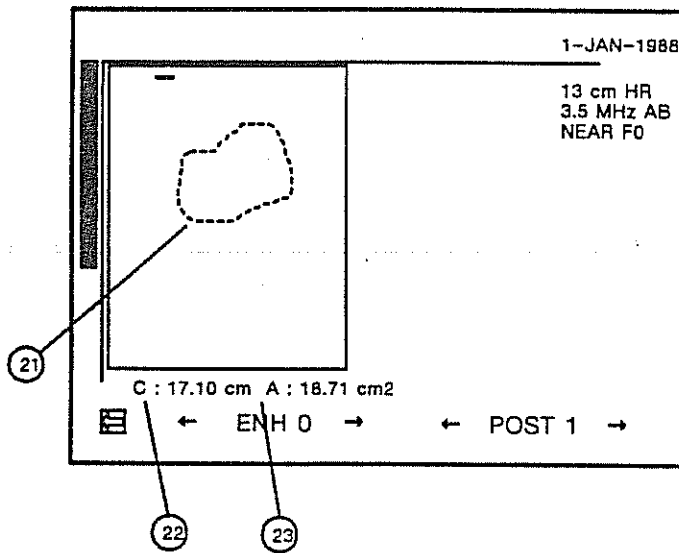

2D Area measurement

- ②1 Area/circumference markers.
- ②2 Circumference (in cm).
- ②3 Area (in cm²) only displayed when dotted line is closed.

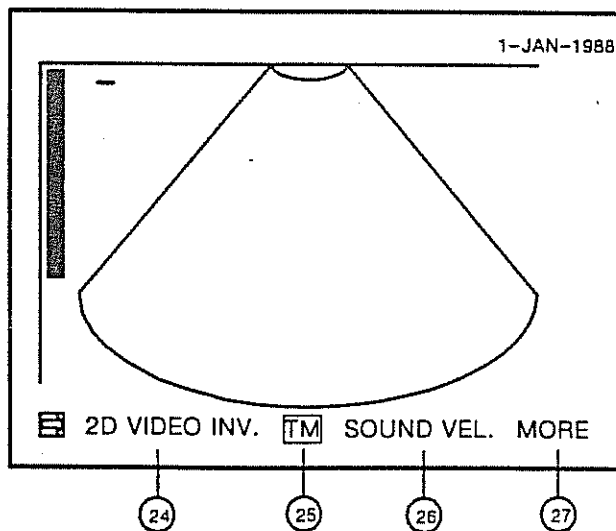

2D Image, set personal parameters

- ②4 Video polarity of whole display.
- ②5 Video polarity of TM trace. If inverted, written in B/W.
- ②6 Programming of sound velocity *.

* Sound velocity :
 1386 m/s (min.)
 1694 m/s (max.)

Press Softkey IV ("more")

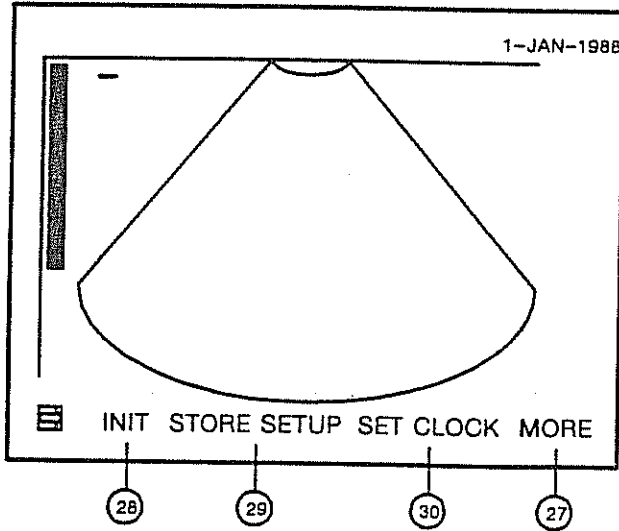

2D Image, set Personal parameters (cont.)

- 27 Select next line of menu
- 28 Programming of power-up parameters.
- 29 Programming of set-up parameters.
- 30 Initialization of date and time.

Return back to the previous display by pressing Softkey IV ("MORE").

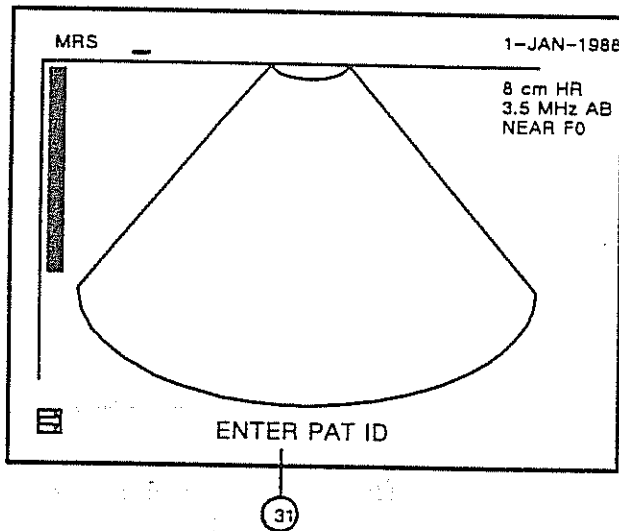

2D, Enter Patient Identification

- 31 Initialization of patient identification data (37 characters maximum).

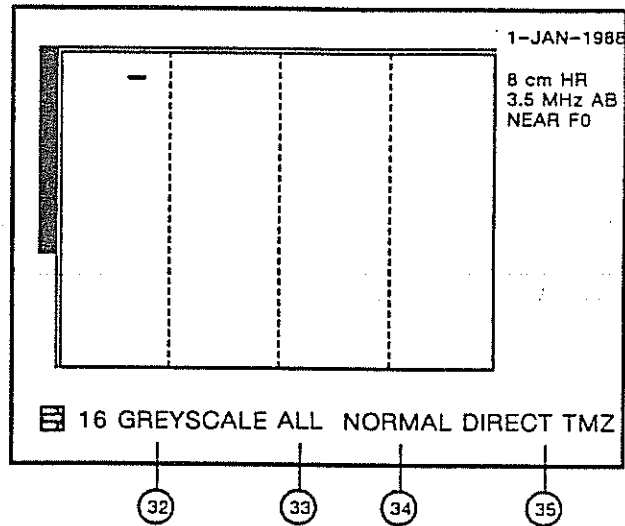

- ③② **Softkey I** (to obtain the 16 level greyscale)
- ③③ **Softkey II** (to obtain a gray scale with all 60 levels)
- ③④ **Softkey III** (to return to normal imaging)
- ③⑤ For service personnel only. LSR processing is switched off.

Note

If a Sigma Doppler is connected to Sigma 1 AC and switched-on, the TM-image is displayed on the Doppler monitor. The Sigma 1 AC monitor still displays the 2D image.

3.6 Cine mode

The Cine Mode is a specific function used to analyze a biological movement.

Note

The Cine mode is only possible with sectorial transducer.

The Cine Mode enables to record 12 sectorial pictures in the Sigma 1 AC memory. However, the image resolution of stored picture is reduced by a factor of 2. These 12 pictures can be displayed as a movie or analyzed picture by picture. Note that the Cine Mode is especially powerful in cardiology : the 12 pictures are recorded simultaneously to the ECG and displayed in correspondence with the ECG.

3.6.1 Storing pictures

Press the **CINE** touchkey to enter in Cine Mode. The recording of the 12 latest pictures is starting.

The Sigma 1 AC screen displays :

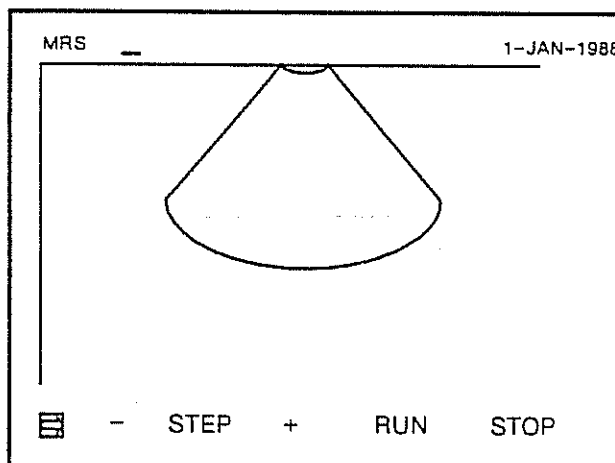

Press the **FREEZE** touchkey or the **STOP Softkey** to stop recording. The latest picture is displayed. A ruler including 12 ticks (1 tick showing 1 picture) is displayed on the screen. The widest tick indicates the displayed picture.

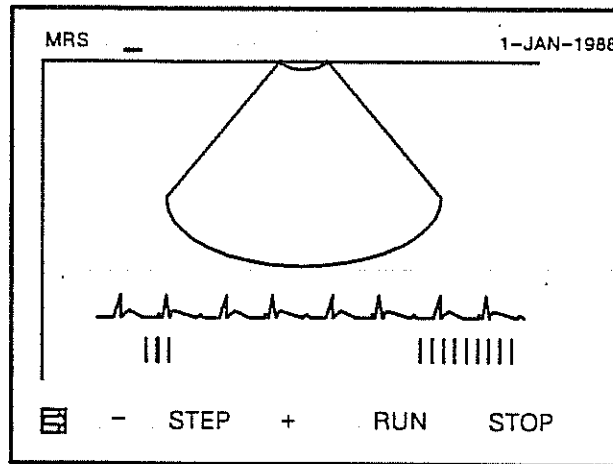

Note

By pressing the **FREEZE** touchkey, the previous stored pictures are overwritten. The new recording is beginning. The ruler is cleared.

Important

It is possible to record the pictures without ECG by pressing **ECG NO**.

3.6.2 Displaying pictures image by image

Press the **STEP - Softkey** to select the previous image or **STEP +** to select the next picture. The large tick indicates the displayed image corresponding to the ECG.

3.6.3 Displaying pictures as movie

Press the **RUN Softkey** to display the 12 pictures as movie.

The Sigma 1 AC screen displays :

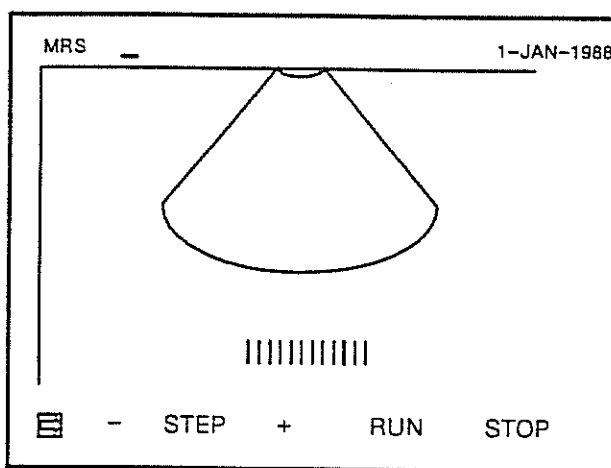

3.6.4 Changing the running speed

The speed of movie can be increased or decreased

Press the **Softkey SPEED -** or **+** to modify the speed (keeping the softkey depressed, change the speed continuously).

3.6.5 Stopping movie

Press the **STOP** softkey to stop the movie. The screen returns to the "STEP" menu (see section 3.6.1).

3.6.6 Exit of the cine mode

Press the **FREEZE** touchkey if the picture is frozen.

Press the **2D x 1** touchkey to exit from Cine Mode.

Important

Any start of measurement sequence stops recording or running. During measurements, stepping through pictures is not possible.

4. BIOMETRY

4.1 Biometric functions

4.1.1 General

This section describes the biometry features of the Sigma 1 AC and measurement technics. The functions described (and illustrated) are :

| Function | Paragraph |
|---------------------------|-----------|
| GENERAL MEASUREMENT | 4.2 |
| OBSTETRICS AND GYNECOLOGY | 4.3 |
| CARDIOLOGY | 4.4 |
| INTERNAL MEDICINE | 4.5 |
| USER FUNCTION | 4.6 |

4.1.2 Conventions

The conventions used in this section are :



Keyboard entries.



Screen options that are selected by Multifunction Softkeys I, II, III, and IV

To simplify these procedures and because the appropriate Softkey is located under the option that will be described herein, the Softkey is not mentioned in these procedures but it is assumed that the screen options are accessed by the associated Softkey.

4.1.3 Positioning Markers

Marker positioning is done with the TRACKBALL .

4.1.4 Biometric functions flow chart

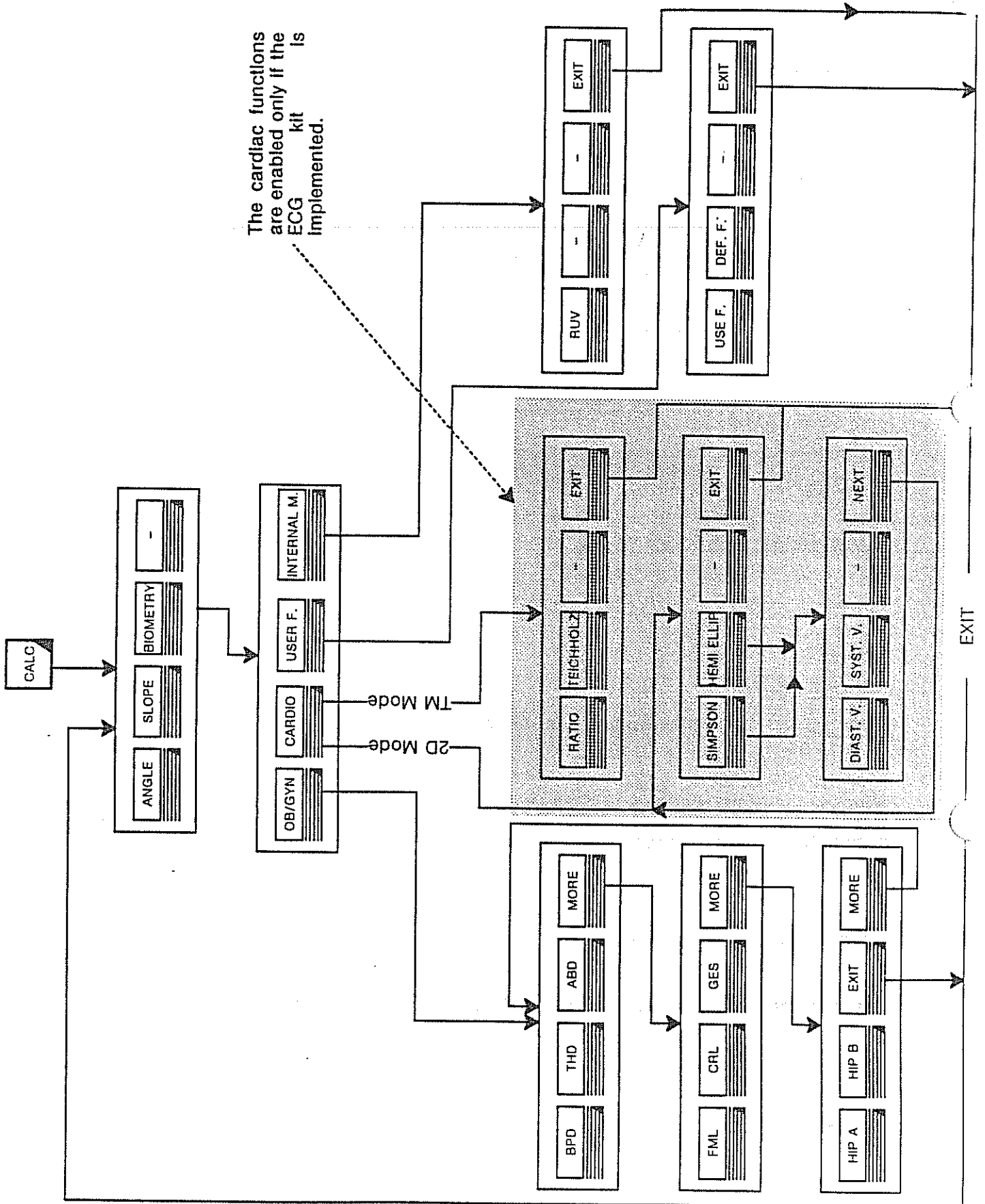

4.2 General measurements (refer also to paragraph 2.1.3.3)

4.2.1 Angle

To calculate an angle (in degrees) :



Position markers M1, M2, and M3.

The angle, in this case 60° is displayed as shown.

The shaped cross is the center of the angle.

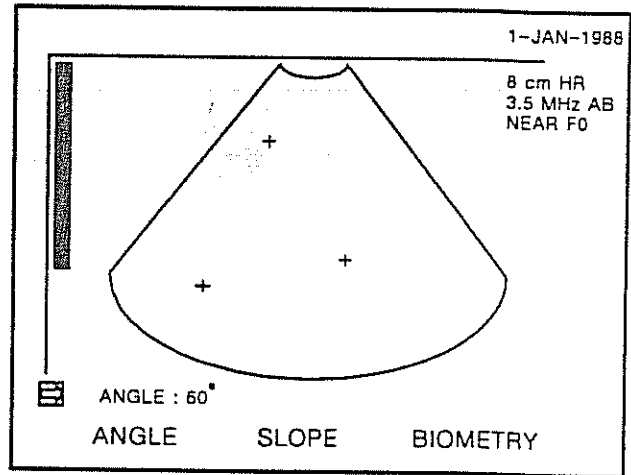

4.2.2 Slope

To calculate a slope (in cm per second)



Position first marker (M1)



Position second marker (M2)

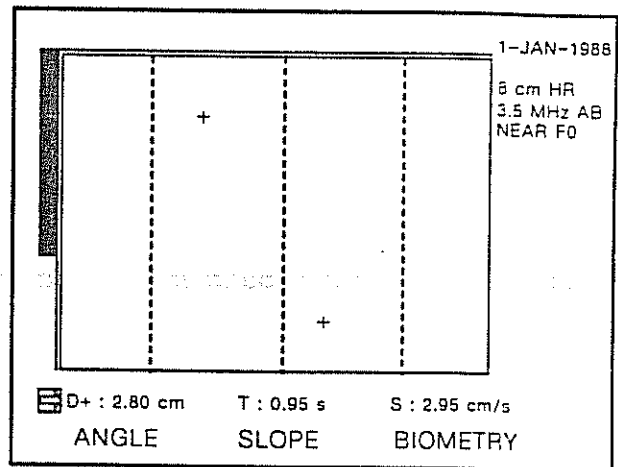

The slope distance, slope time, and slope calculation are displayed as shown. In this illustration they are :

D+ : 2.80 cm T : 0.95 s S : 2.95 cm/s

4.3 Obstetrics and gynecology

4.3.1 Biparietal Diameter

To determine the biparietal diameter :



Input : Distance d
 *R (1540) : 2.35 cm < d < 10.40 cm

Output: Week of pregnancy 13.0 < w < 37
 Projected birth date.



Position first marker (M1)

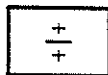

Position second marker (M2)

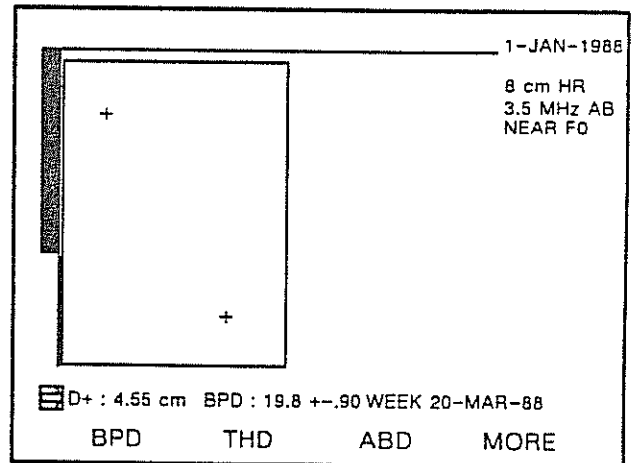

The distance, biparietal diameter, and projected birth date are displayed as shown. In the illustration they are :

D+ : 4.55 cm BPD : 19.8 + .90 WEEK 20-MAR-88

* Range is given for the sound velocity setting of 1540 m/s.

4.3.2 Thorax diameter

To determine the thorax diameter :



Input : Distance d R (1600) :
3.00 cm < d < 10.40 cm

Output: Week of pregnancy
15.5 < w < 41.0
Projected birth date

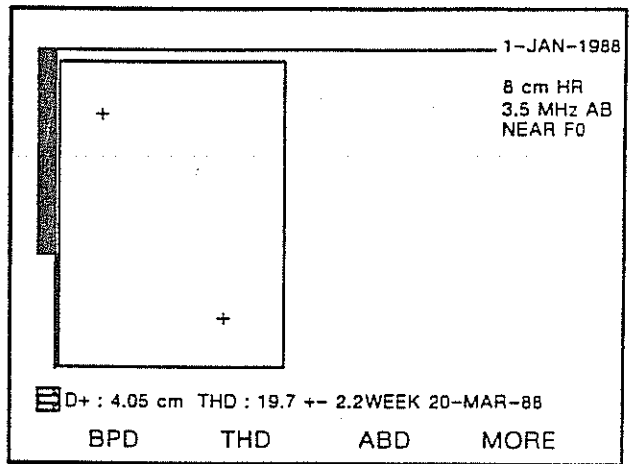

Position first marker (M1)



Position second marker (M2)

The distance, thorax diameter, and projected birth date are displayed as shown. In this illustration they are :

D + : 4.05 cm THD : 19.7 + 2.2 WEEK 20-MAR-88

4.3.3 Abdominal diameter

To determine the abdominal diameter :



Input : Distance d
R (1540)
5.18 cm < d < 10 cm

Output: Week of pregnancy
22 < w < 40
Projected birth date

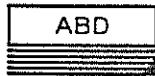

Position first marker (M1)



Position second marker (M2)

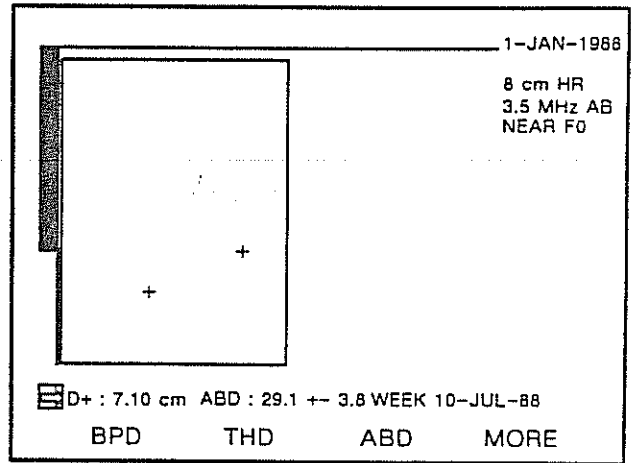

The distance, abdominal diameter, and projected birth date are displayed as shown. In this illustration they are :

D + : 7.10 cm ABD : 29.1 +/- 3.8 WEEK 10-JUL-88

4.3.4 Femur length

To determine the femur length :

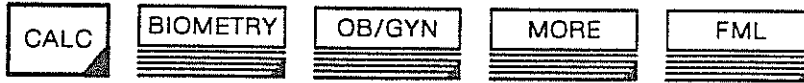

Input :Distance d
 R (1540) :
 1.04 cm < d < 7.34 cm

Output: Week of pregnancy
 13 < w < 41
 Projected birth date.



Position first marker (M1)



Position second marker (M2)

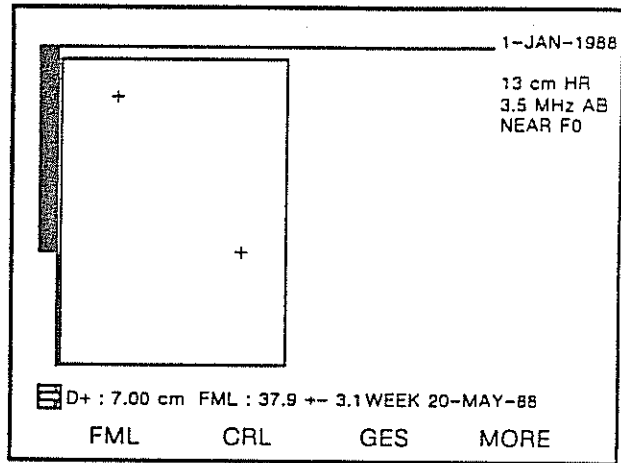

The distance, femur length, and projected birth date are displayed as shown. In this illustration they are :

D + : 7.00 cm FML : 37.9 +/- 3.1 WEEK 20-MAY-88

4.3.5 Crown rump length

To determine the crown rump length :

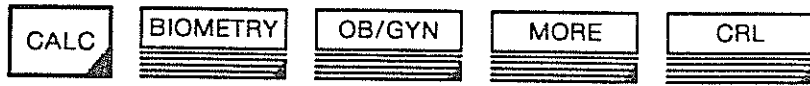

Input : Distance d
R (1540) :
0.42 cm < d < 7.83 cm

Output: Week of pregnancy
6 < w < 14
Projected birth date



Position first marker (M1)



Position second marker (M2)

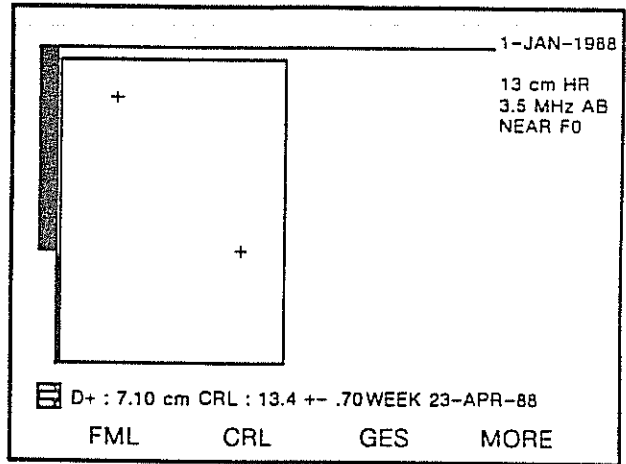

The distance, crown rump length, and projected birth date are displayed as shown. In this illustration they are :

D + : 7.10 cm CRL : 13.4 +- .70 WEEK 23-APR-88

4.3.6 Gestational sac

To determine the gestational sac measurement :



Input : Distance d
 R (1540) :
 0.77 cm < d < 5.71 cm

Output: Week of pregnancy
 5 < w < 12
 Projected birth date



Position first marker (M1)



Position second marker (M2)

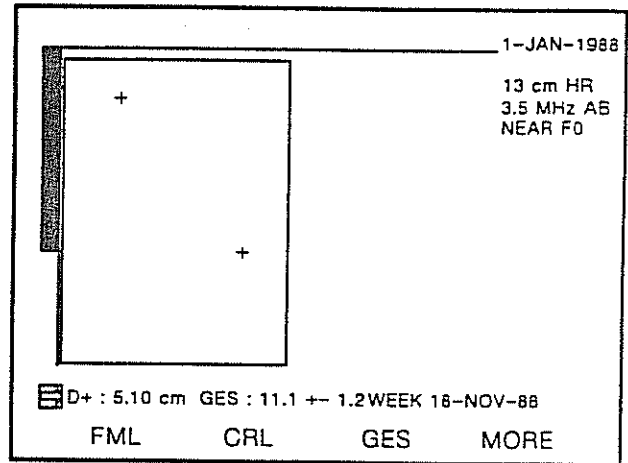

The distance, gestational sac measurement, and projected birth date are displayed as shown. In this illustration they are :

D+ : 5.10 cm GES : 11.1 +/- 1.2 WEEK 18-NOV-88

4.3.7 Hip angle

This measurement characterizes hip defects according to the hip angle, as follows :

Entry:

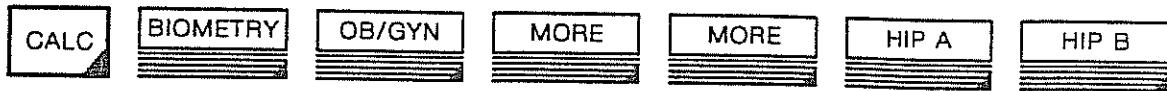

Input : Angle $0^\circ < \alpha < 180^\circ$

Output: Type I Through IV



Position first marker (M1)



Position second marker (M2)



Position third marker (M3)

The angle, hip A or B and type are displayed as shown.

In the first illustration :

ANGLE : 82° HIP A : TYPE I

In the second illustration :

ANGLE : 99° HIP B : TYPE III / IV

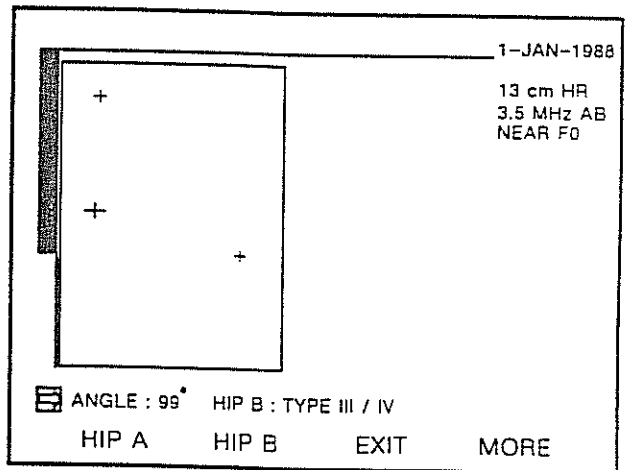
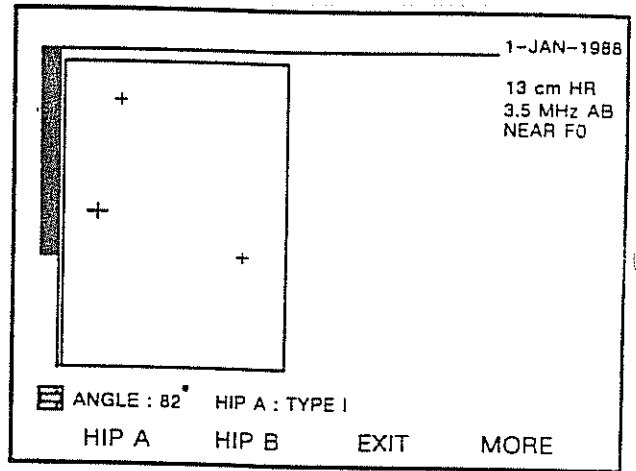

4.4 Cardiology (enabled only if the ECG kit is implemented)

4.4.1 Ratio

To calculate the ratio (in percent) :



Input : Distance D +, D +

Output: $(D_{max} - D_{min}) / D_{max}$
in percentage



Position first marker of D+

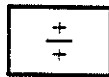

Position second marker of D+

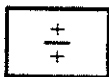

Position first marker of D+

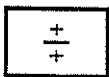

Position second marker of D+

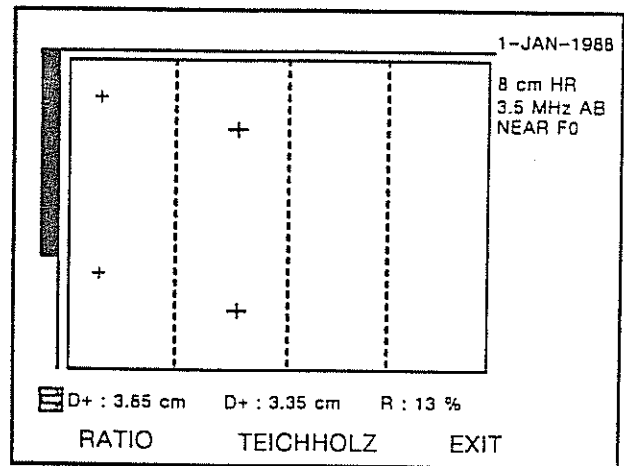

The distance (D+), distance (D+), and ratio are displayed as shown. In this illustration they are :

D+ : 3.85 cm D+ : 3.35 cm R : 13 %

4.4.2 Teichholz

To calculate volume using the Teichholz formula :

Enter:



Input : Distance D+, D+
R : 0 < D < 10 cm

Output: $V = \frac{7}{2.4 + D+} \times D^{3+}$

and

$$V = \frac{7}{2.4 + D+} \times D^{3+}$$

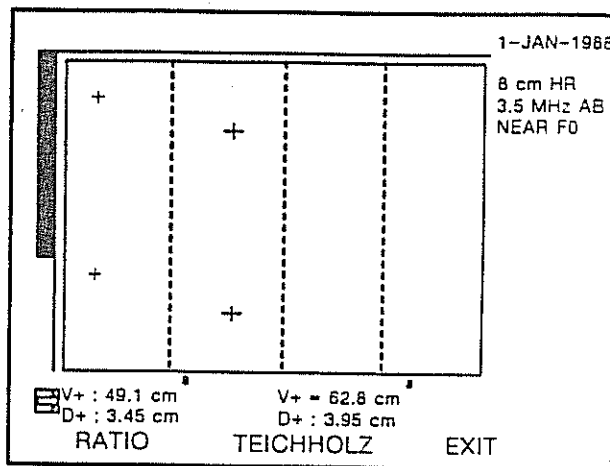
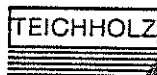

Position first marker of D+

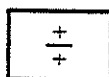

Position second marker of D+
(wait for display of V+)

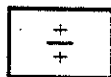

Position first marker of D+



Position second marker of D+
(wait for display of V+)

The distance (D+), distance (D+), volume (V+), and volume (V+) are displayed as shown. In this example they are :

D+ : 3.45 cm D+ : 3.95 cm V+ : 49.1 cm³ V+ : 62.8 cm³

4.4.3 Simpson

To calculate ventricular volume :

Entry :



Input : L ventricular length
 A1 mitral Area
 A2 papilluar Area

Output: $V = \frac{L}{3} (A1 + \frac{2}{3} A2)$



Position first marker of L.
 MEASURE VENTRIC. LENGTH is displayed on the screen.



Position second marker of L.
 The display is D+ : 2.70 cm .



Validation of L, new image for A1.
 MEASURE MITRAL AREA is displayed on the screen.

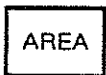

Position marker

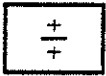

Measure Area A1.
 The display is A1 : 6.39 cm²



Validation of A1, new image for A2.
 MEASURE PAPIL. AREA is displayed on the screen.



Position marker

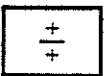

Measure Area A2.
 The display is A2 : 9.42 cm²



Validation of A2.
 The display is SIMPSON : 17.1 cm³

4.4.4 Hemi-Ellipse

To calculate ventricular volume :

Entry:



Input : L ventricular length
A ventricular Area

Output : $V = \frac{5}{6} L \times A$



Position first marker of L.
MEASUREMENT VENTRIC. LENGTH is displayed on the screen.

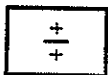

Position second marker of L.
The display is D + : 3.70 cm .



Validation of L, new image for Area.
MEASUREMENT PAPIL. AREA is displayed on the screen.

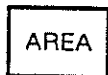

Position marker



Measure Area A. The display is A : 9.22 cm²



Validation of A.
The display is HEMI ELLIPSOID : 28.4 cm³ .

4.4.5 Stroke volume and ejection fraction

Entry : Through Simpson (see chapter 4.4.3) or Hemi-Ellipse (chapter 4.4.4)

Input : DI Diastolic Volume
 SY Systolic Volume
 both calculated by Simpson or Hemi-Ellipsoid equation.

Output: SV = DI - SY Stroke volume

$$EF = \frac{DI - SY}{DI} \times 100 \quad \text{Ejection Fraction In Percent}$$

HEMI ELLIP or **SIMPSON** Measure Diastolic Volume

DIAST. V. Enter as Diastolic Volume

HEMI ELLIP or **SIMPSON** Measure Systolic Volume

SYST. V. Enter as Systolic Volume

The display is : DI : 120.2 cm³ SY : 40.0 cm³ SV : 80.2 cm³ EF : 66.7 %

4.5 Internal medicine

4.5.1 Residual Urine Volume

To calculate the residual urine volume :

Entry:



Input : A1 transversal Area R (1540) $5 \text{ cm}^2 < A < 80 \text{ cm}^2$
A2 longitudinal Area

Output: Volume of residual urine



Position marker.
POSITION L.SEC AREA is displayed on the screen.

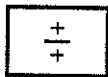

Measure transversal area A1.
The display is A : 9.15cm² .



Validate A1, new image.
MEASURE T. SEC AREA is displayed on the screen.

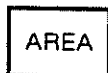

Position marker.



Measure longitudinal Area A2.
The display is A : 28.59cm² .



Validate A2.
The display is RUV : 73.8 + 11 cm³ .

4.6 User function

The principle of the user function is to program and use a function that predicts the birth weight.

(Estimation of Fetal Weight, S. Campbell and D. Wilkin, British Journal of Obstetrics Vol. 82, N 9, 1975)

The conventions used in this paragraph are :



Keyboard entries



Screen options that are selected by Multifunction Softkeys I, II, III, and IV .

4.6.1 Entering a new user function

Entry:



| DISPLAY | INPUT | EXPLANATION |
|--|-------------------------|---|
| | DEF.F. | Define user function |
| SELECT FUNCTION | F1 | Function F1 |
| | NEW F. | New function |
| INPUT OF USER FUNCTIONS | | |
| ENTER FUNCTION NAME : <u>BW</u> | BW | Max four characters |
| ENTER SOUND VELOCITY : <u>1540</u> | 1540 | Velocity for table |
| | LINE FEED or SPACE | |
| SELECT INPUT MODE : <u>CIRC</u> | CIRC | Input into the user function is a circumference |
| ENTER OUTPUT DIMENSION : <u>KG</u> | KG | Max three characters |
| | LINE FEED or SPACE | |
| ENTER TABLE- ENTER LINE FEED AT THE END OF THE TABLE | | |
| X (cm) Y (KG) E (KG) | | |
| 21.0 0.9 .14 | 21sp* 0.9sp .14sp | |
| 25. 1.51 .22 | 25sp 1.51sp .22sp | Number are finished by a space |
| 30. 2.49 .36 | etc. | |
| 35. 3.47 .5 | | |
| 40. 4.1 .62 | | .62sp |
| X : Input | LINE FEED | End of table is marked with line feed |
| Y : output | | |
| E : possible output error (+/- E) | | |

* sp means SPACE

4.6.2 Using a user function

Example : Estimate birth weight BW 32 Weeks

Entry:



Make measurement (position first caliper)



Measure circumference

The display is : C : 25.10 cm A : 35.06 cm² BW : 1.525 + .22 kg

4.6.3 Listing a user function

Entry:



List user function BW

USER FUNCTION BW

SOUND VELOCITY 1540 M/S

| X (cm) | Y (KG) | E (KG) |
|--------|--------|--------|
| 21.00 | 0.900 | .1400 |
| 25.00 | 1.510 | .2200 |
| 30.00 | 2.490 | .3600 |
| 35.00 | 3.470 | .5000 |
| 40.00 | 4.100 | .6200 |

4.6.4 Editing a user function

Entry :



Select one of the operations below.

4.6.4.1 Sound Vel.

Entry:

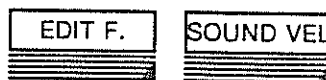

Enter new sound velocity for function selected.

The display is : ENTER SOUND VELOCITY : 1550

4.6.4.2 Line

Edit one of the lines of the user function.

Entry:



A. Insert a line before line number n (2)

| DISPLAY | | | INPUT | | |
|---------------------|--------|--------|-------------|-------|------|
| ENTER LINE NUMBER 2 | | | LINE | | |
| | | | 2 sp | | |
| X (cm) | Y (cm) | E (KG) | | | |
| 5.00 | 1.510 | .220 | | | |
| SELECT OPERATION | | | | | |
| ENTER NEW LINE | | | INSERT LINE | | |
| X (cm) | Y (cm) | E (KG) | | | |
| 23.56 | 4.2 | .1 | 23.56sp | 4.2sp | .1sp |

Change line number n (2)

| DISPLAY | INPUT |
|--------------------------------|-----------------------------|
| ENTER LINE NUMBER 2 | LINE |
| X (cm) Y (cm) E (KG) | 2 sp |
| 23.56 4.200 .1000 | |
| SELECT OPERATION | |
| ENTER CHANGED LINE | CHANGE LINE |
| X (cm) Y (cm) E (KG) | |
| 23. 1.18 .18 | 23sp 1.18sp .18sp |

Clear line number n (2)

| DISPLAY | INPUT |
|--------------------------------|----------|
| ENTER LINE NUMBER 2 | LINE |
| X (cm) Y (cm) E (KG) | 2 sp |
| 23.00 1.180 .1800 | |
| SELECT OPERATION | |
| LINE IS DELETED | CLEAR L. |

4.6.4.3 Clear F.

Clear a user function.

Entry:

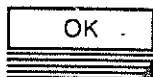

Function will be lost



Function is not lost

4.7 Specific Biometry for U.S. Users

4.7.1 Biometric functions

4.7.1.1 General

This section describes the biometry features of the Sigma 1 AC and measurement technics. The functions described (and illustrated) are :

| Function | Paragraph |
|---------------------------|-----------|
| GENERAL MEASUREMENT | 4.2 |
| OBSTETRICS AND GYNECOLOGY | 4.3 |
| CARDIOLOGY | 4.4 |
| INTERNAL MEDICINE | 4.5 |
| USER FUNCTION | 4.6 |

4.7.1.2 Conventions

The conventions used in this section are :



Keyboard entries.



Screen options that are selected by Multifunction Softkeys I, II, III, and IV

To simplify these procedures and because the appropriate Softkey is located under the option that will be described herein, the Softkey is not mentioned in these procedures but it is assumed that the screen options are accessed by the associated Softkey.

4.7.1.3 Positioning Markers

Marker positioning is done with the TRACKBALL .

4.7.1.4 Biometric functions flow chart

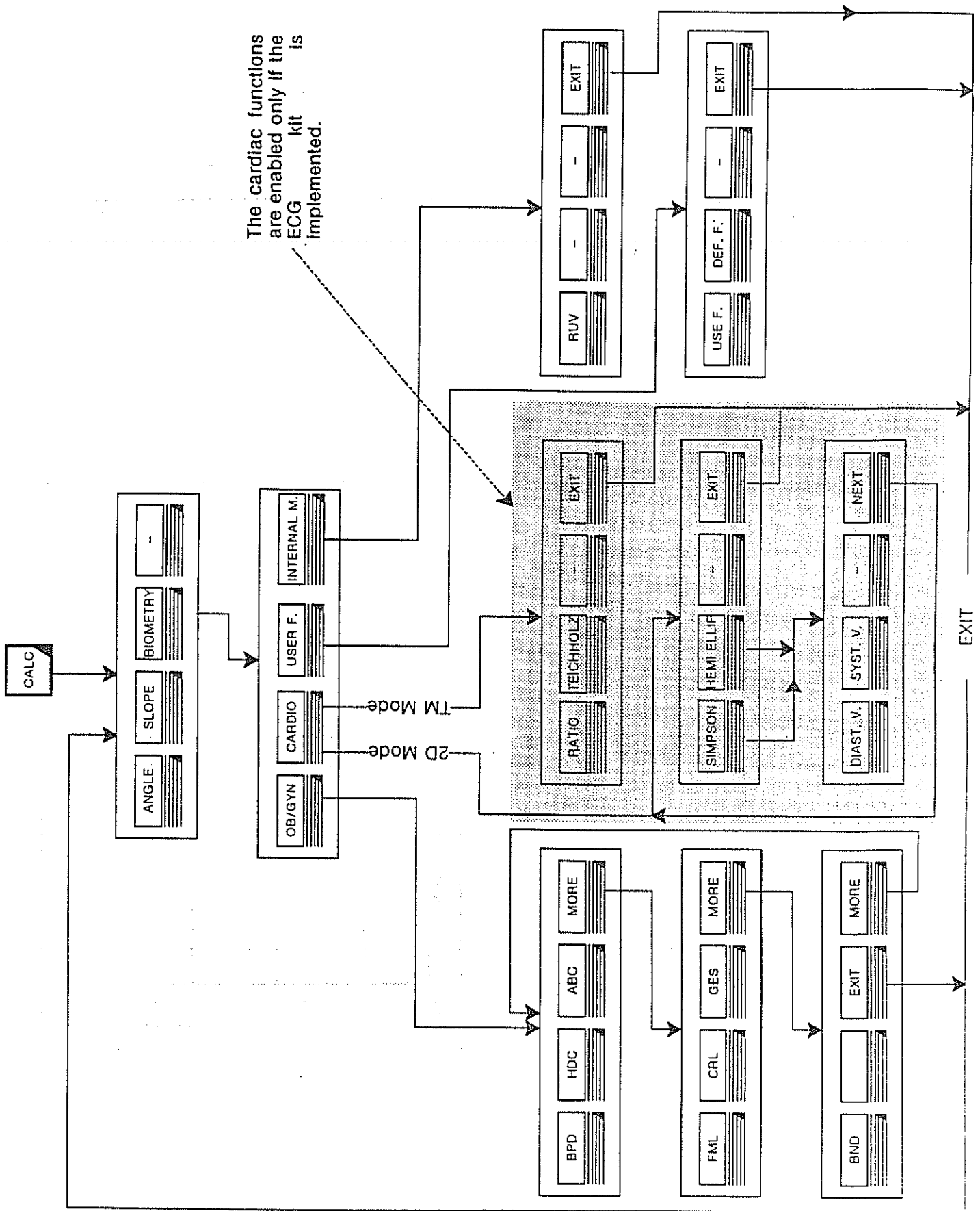

4.7.2 General measurements (refer also to paragraph 2.1.3.3)

4.7.2.1 Angle

To calculate an angle (in degrees) :



Position markers M1, M2, and M3.

The angle, in this case 60° is displayed as shown.

The shaped cross is the center of the angle.

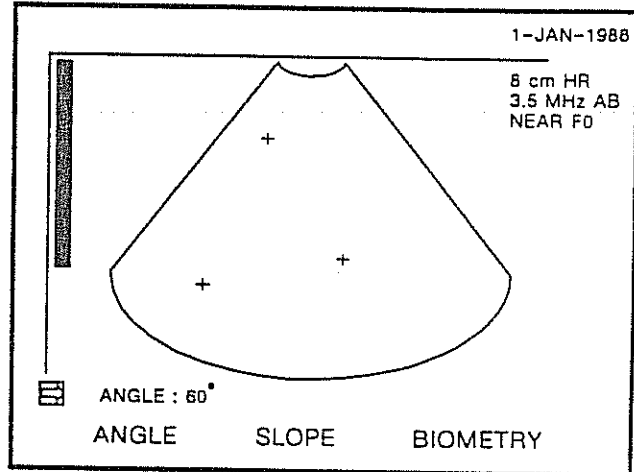

4.7.2.2 Slope

To calculate a slope (in cm per second)



Position first marker (M1)

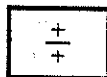

Position second marker (M2)

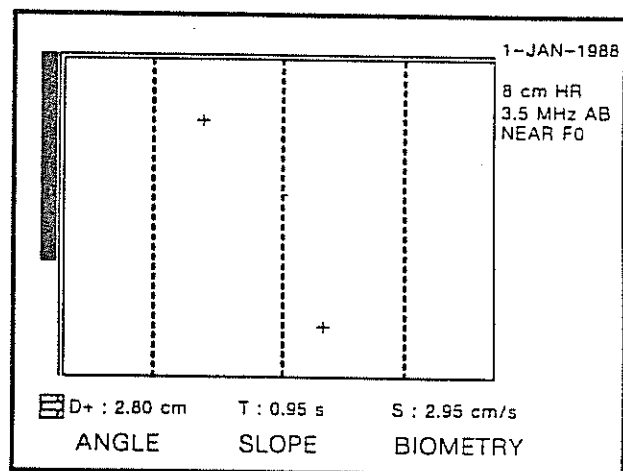

The slope distance, slope time, and slope calculation are displayed as shown. In this illustration they are :

D+ : 2.80 cm T : 0.95 s S : 2.95 cm/s

4.7.3 Obstetrics and gynecology

4.7.3.1 Biparietal Diameter

To determine the biparietal diameter :



Input : Distance d
R (1540)
2.00 cm < d < 9.70 cm

Output: Week of pregnancy
12.4 < w < 40
Projected birth date

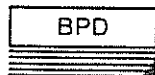

Position first marker (M1)

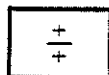

Position second marker (M2)

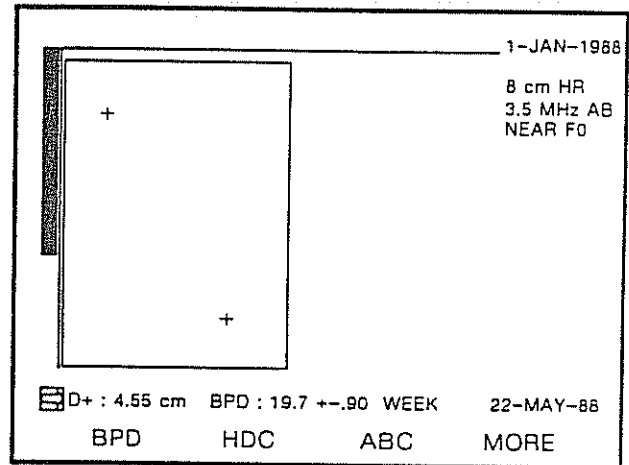

The distance, biparietal diameter, and projected birth date are displayed as shown. In the illustration they are :

D+ : 4.55 cm BPD : 19.7 +- .90 WEEK 22-MAY 88

* Range is given for the sound velocity setting of 1540 m/s.

4.7.3.2 Head circumference

To determine the Head circumference :



Input : Circumference c
 R (1540)
 12.4 cm < c < 36 cm

Output: Week of pregnancy
 16.0 < w < 41.0
 Projected birth date

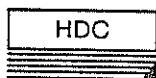

Position first marker (M1)

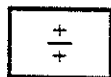

Position second marker (M2)

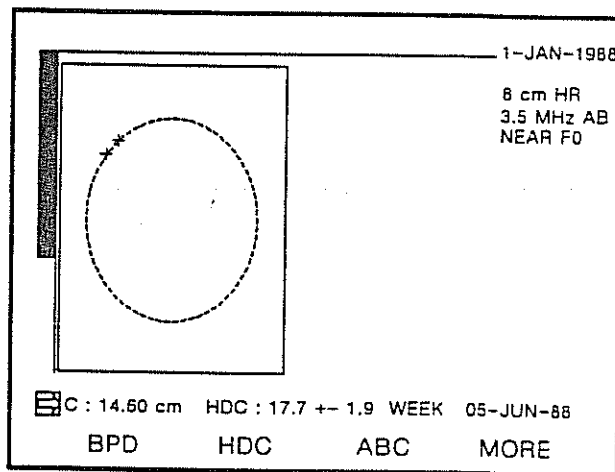

The Head circumference and projected birth date are displayed as shown. In this illustration they are :

C : 14.60 cm HDC : 17.7 +- 1.9 WEEK 05-JUN-88

4.7.3.3 Abdominal circumference

To determine the abdominal circumference :



Input : Circumference c
 R (1540)
 10.5 cm < c < 35.4 cm

Output: Week of pregnancy
 16 < w < 40
 Projected birth date

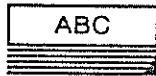

Position first marker (M1)

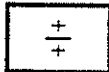

Position second marker (M2)

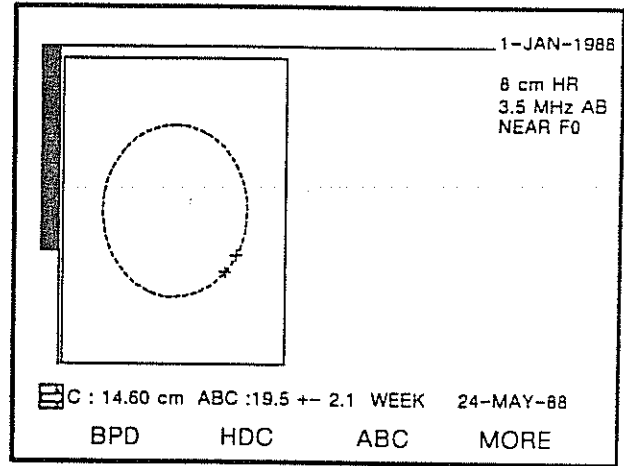

The abdominal circumference and projected birth date are displayed as shown. In this illustration they are :

C : 14.60 cm ABC : 19.5 +- 2.1 WEEK 24-MAY-88.

4.7.3.4 Femur length

To determine the femur length :

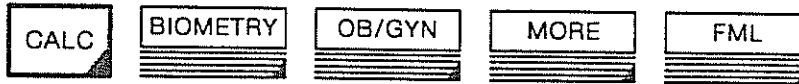

Input :Distance d
 R (1540) :
 1.05 cm < d < 7.30cm

Output: Week of pregnancy
 13 < w < 40.6
 Projected birth date.



Position first marker (M1)

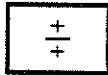

Position second marker (M2)

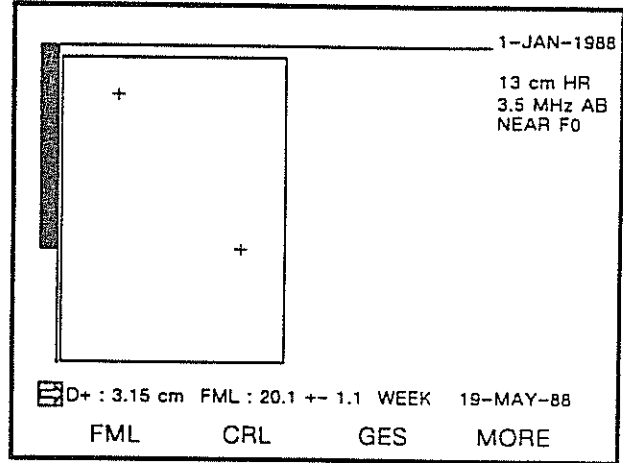

The distance, femur length, and projected birth date are displayed as shown. In this illustration they are :

D + : 3.15 FML : 20.1 +- 1.1 WEEK 19-MAY-88

4.7.3.5 Crown rump length

To determine the crown rump length :

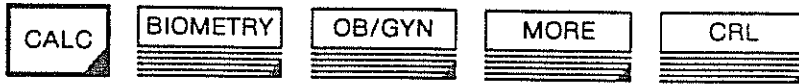

Input : Distance d
 R (1540) :
 0.50 cm < d < 5.40 cm

Output: Week of pregnancy
 6.35 < w < 12.14
 Projected birth date

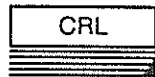

Position first marker (M1)



Position second marker (M2)

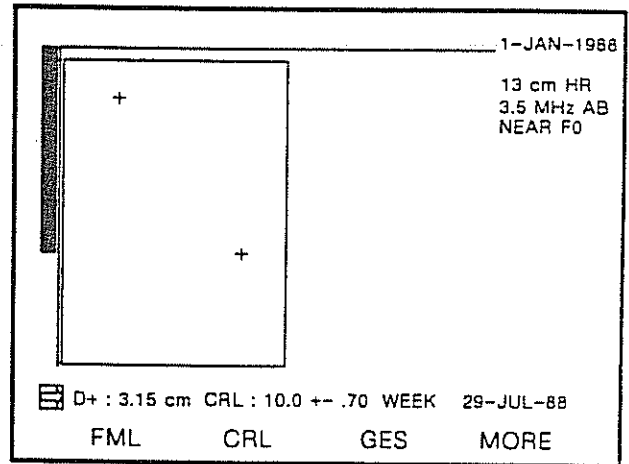

The distance, crown rump length, and projected birth date are displayed as shown. In this illustration they are :

D + : 3.15 cm CRL : 10.0 +- .70 WEEK 29-JUL-88

4.7.3.6 Gestational sac

To determine the gestational sac measurement :

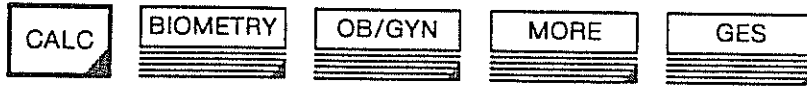

Input : Distance d
 R (1540) :
 1.00 cm < d < 6.00 cm

Output: Week of pregnancy
 5 < w < 12.2
 Projected birth date



Position first marker (M1)



Position second marker (M2)

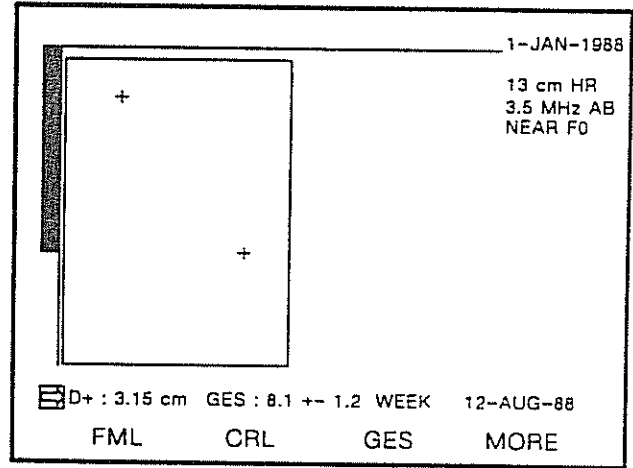

The distance, gestational sac measurement, and projected birth date are displayed as shown. In this illustration they are :

D+ : 3.15 cm GES : 8.1 +/- 1.2 WEEK 12-AUG-88

4.7.3.7 Binocular distance

To determine binocular distance :

Entry:

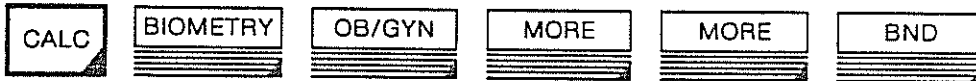

Input : Distance d
 R (1540) :
 1.6 cm < d < 6 cm

Output: Week of pregnancy
 12 < w < 40
 Projected birth date

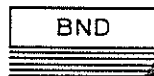

Position first marker (M1)



Position second marker (M2)

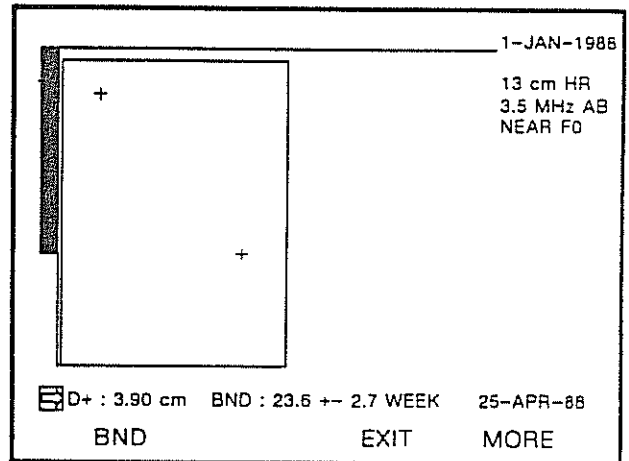

The binocular distance and projected birth date are displayed as shown in this illustration. They are :

D + : 3.90 cm BND : 23.6 +- 2.7 WEEK 25-APR-88

5. APPENDICES

5.1 Sigma 1 AC installation and preparation for transport

5.1.1 Introduction

The Sigma 1 AC is used in an examination room or near the patient's bed on a firm free-standing table (or optional equipment, Sigma 1 AC cart) capable of supporting a 40 kg load without danger.

5.1.2 Unpacking

The following tools are required :

- knife
- cutting pliers
- screwdriver.

5.1.3 Power source connection

Check that the local line supply voltage corresponds to the value given on the data plate. Variations in line supply voltage must not under any circumstance exceed the limits shown in the table below.

5.1.4 Matching the line voltage

If necessary, the supply voltage of the Sigma 1 AC can be changed by modification of an internal switch (by qualified KONTRON INSTRUMENTS service personnel). This modification must be made by a technician from the distributor's maintenance department who must ensure that the new supply voltage is clearly and unambiguously marked on the date plate.

The following values and types should be used for F1 and F2 :

| Line Voltage | Consumption | Fuses |
|--------------|----------------|------------------|
| 95 to 130 V | 1.9 to 1.5 A | 2 x D1 TD 3.15 A |
| 190 to 260 V | 0.95 to 0.80 A | 2 x D1 TD 1.6 A |

5.1.5 Safety rules

Caution

The Sigma 1 AC is designed to operate on a single phase line supply. The unit is automatically grounded via the power cable, provided that a 3-pin wall socket whose third pin is grounded, is used. The patient's bed can be connected to the unit through the equalization potential terminal provided for this purpose on the rear panel of the unit.

5.1.6 Matching the TV standard

The Sigma 1 AC can be matched to either the 625 line, 50 Hz or the 525 line, 60 Hz standard. Matching the TV standard must be done by the distributor's maintenance department technician.

5.1.7 Switching on for the first time

5.1.7.1 Connections and Checks with Power OFF

1. Before plugging the cable into a wall socket, check that :

The active face of the transducer is perfectly clean.
The Monitor's screen is clean.
The front panel video switch is on **LINE** position.

2. Mount the camera and its attachment fittings on the housing and check that it swings freely.
3. Check that the following cables are connected correctly and securely :
 - Transducer cable (front lower panel).
 - Footswitch cable (rear panel)
 - TM recorder cables (rear panel).
4. Check that power switch is **OFF**.
5. After checking that the supply voltage is compatible with the instrument, the Sigma 1 AC can be plugged into the supply.

5.1.7.2 Testing with power ON

Move the power switch to the **ON** position and check that the green indicator appears on the **ON-OFF** button and that an image appears on the screen (at the same time, a green indicator lamp illuminates on the panel under the keyboard).

Adjust **INTENSITY** and **CONTRAST** controls (under the keyboard) to obtain the desired brightness and the right greyscale.

5.1.8 Preparation for transport

Follow these procedures :

1. Unplug the power cable
2. Disconnect the FREEZE control footswitch on rear panel.
3. Disconnect the transducer cables) from the front lower panel.
4. Remove the camera from its attachment fittings.
5. Remove the transducer holder.
6. Pack away cables, footswitch, external monitor, transducers) and camera.
7. Disconnect both monitor cables on rear panel.

Caution

Take all appropriate precautions to avoid impact damage to the active face of the transducer. Protect the transducer with the black part of the transducer's holder which can be removed from the support.

For extended storage or when the unit is to be out of use, the batteries should be removed from the Polaroid camera: leakage of the caustic battery solution may cause irreparable damage.

Unused film should be removed and the rollers cleaned.

5.2 Sigma 1 AC polaroid camera use and routine maintenance

5.2.1 Polaroid camera

5.2.1.1 Checking the camera

Check the camera shutter speed setting (white value opposite white pointer) : 2 sec. for type 611 film. Load the camera with film and batteries.

5.2.1.2 Loading the camera

Note

The rollers must be cleaned each time the film is changed. Therefore, follow the cleaning instructions inside the film door.

1. Insert a film and release it.
2. Shut and lock the film door.
3. Pull away the black paper.
4. The camera is now ready.

Note

Sigma 1 AC is factory adjusted for use with Polaroid type 611 film.

INTENSITY and **CONTRAST** pre-setting controls should not be modified each time the equipment is switched **ON**.

5.2.1.3 Loading the batteries

1. Open the camera rear trap.
2. The battery holder is attached to the camera by a "Velcro" strip. Pull the battery to separate it from the camera housing.
3. Separate the connector from the battery holder, taking care not to pull away the electronic shutter board power supply wires. (Use a coin or screwdriver).
4. Insert the batteries according to the marks at the bottom of each battery holder connector.
5. Fit the battery holder connector.
6. Fit the battery holder to the "Velcro" strip.

5.2.1.4 Photography procedures

First check the image display on the screen. If the display is not correct, readjust the image brightness and gain. The screen image can be frozen before taking a photography by operating the **FREEZE** touchkey or footswitch.

1. Swing the camera into position
2. Press the shutter release
3. Pull out the numbered white tab.
4. Pull out the black and yellow strip.
5. Wait for the necessary time.
6. Separate the photo from its backing.

5.2.1.5 Battery type

The polaroid camera uses 4 alkaline batteries with the following designation :

| CEI reference | International designation | ASA | Japanese code | Mallory |
|------------------|------------------------------|-----|------------------|---------|
| LR 6 | Mignon | AA | AM 3 | Mn 1500 |

5.3 Sigma 1 AC technical specification

Linear

| | |
|--------------------------|--|
| Scanning method | Electronic linear scanning (curved linear) |
| Display Modes | Real time B-Mode Dual-Image B-Mode (also mixed with sector) M-Mode (moving Bar) Simultaneous B- and M-Mode ECG-synchronized B-Mode |
| Frequencies | 3.5 MHz, 5 MHz, 7.5 MHz |
| Scan width | 51 mm ... 107 mm (linear) 51 mm ... 67 mm at skin level, 48.4 (curved linear) |
| Number of Crystal | 93 ... 108 |
| Number of acoustic Beams | 166 ... 196 (Survey) 196 ... 255 (High resolution) |
| Lat. Resolution | 1.2 mm 3.5 MHz linear 1.2 mm 5 MHz linear 1.5 mm 3.5 MHz (curved linear) |
| Axial Resolution | 0.7 mm 3.5 MHz linear 0.5 mm 5 MHz linear 0.7 mm 3.5 MHz (curved linear) |
| Display Range | 23 cm (at 3.5 MHz), 18 cm (other frequencies) |
| Focusing | Dynamic focusing at reception |
| Frame rate | Computer optimized according to depth and Survey/High-Resolution-Switch. |

Sector

| | |
|-----------------|--|
| Scanning Method | Mechanical wobbling sector scanner. |
| Display Modes | Real-Time B-Mode Dual-Image B-Mode (also mixed with linear) M-Mode (moving bar) Simultaneous B- and M-Mode ECG-Synchronized B-Mode Cine mode. |
| Frequencies | 3.5 MHz, 5 MHz, 7.5 MHz |
| Display range | 23 cm (3.5 MHz), 18 cm (other frequencies). |
| Scanning angles | 60, 80, 90, 105. |
| Frame rate | Max 30 frames/sec computer optimized according to transducer, depth and Survey/High-Resolution-Switch. |
| Focusing | Transmit focusing at transmission. Dynamic focusing at reception only with the Annular Array configuration (module + transducer). |

General specifications

| | |
|-------------------|--|
| Gain | Max 120dB, independent slider for B-Mode and M-Mode |
| TGC | 9 sliders for 9 Depth-steps |
| Image Polarity | White on black or black on white, separately selectable for B-Mode and M-Mode |
| Image Processing | Reject with 8 steps Near/far AGC and Enhance with 7 steps Postprocessing with 4 steps Tracking filter |
| Frame Filters | Separate Image Processing for LSR-Output Weak for cardiology Medium for OB/GYN Strong for OB/GYN "MTI" (Moving Target Indicator) |
| M-Mode Speed | 25 mm/s, 50 mm/s, 100 mm/s |
| Image Memory Size | 512 x 512 x 6 bits |
| Gray Shades | 60 |
| Freeze | All displays can be frozen. Measurements can be done on frozen image. |
| ECG-Display | In M-Mode synchronized with moving bar |
| Character Display | 37 character Patient-Identification 32 character Permanent Text with battery backup. Text at any position on the screen possible Battery-backup calendar |
| Measurements | Distance (independent dual measurement) Area, Circumference, Angle (B-Mode) Slope, shortening ratio (M-Mode) |
| Calculations | BDP, THD, ABD, FML, CRL, GES, RUV, HIP A, HIP B Simpson Function, Hemi-Ellipse-Function (B-Mode), Ejection Fraction and Stroke volume (B-Mode), Teichholz-Function (M-Mode) 6 user-programmable functions in battery-backed-up memory . |

Technical specifications

| | |
|--------------------|--|
| Power Requirements | 95 ... 130 V : 1.9 A 190 ... 260 V : 0.95 A |
| Dimensions | 44 (W) x 59 (D) x 23 (H) cm |
| Weight | 28 kg |
| Inputs | Patient ECG VCR Input |
| Outputs | LSR Interface Doppler Interface VCR Output Additional Monitor Output (All video Signals : 1.0 V, 75 Ohms, 625 lines/50 Hz or 525 lines/60 Hz) |
| Monitor | 8 inch diag. with independent regulation photo. |
| Additional Monitor | 9.5 inch diag. |

5.4 Sigma 1 AC transducer scanrates and formats

Linear transducer – 50 Hz Norm

| depth | SCANHEAD | | | | | | | | |
|----------|-------------|--------------------------------|--------------------------------|--------------------------------|--------------------------------|--------------------------------|--------------|--------------------------------|-----|
| | 3.5 MHz lin | | 5.0 MHz lin | | 7.5 MHz lin | | 3.5 MHz curl | | |
| 60 | S | | 25 | 166 | 25 | 170 | | | |
| | HR | | 16 ² / ₃ | 249 | 16 ² / ₃ | 255 | | | |
| 80 | S | 16 ² / ₃ | 196 | 25 | 166 | 25 | 170 | 25 | 170 |
| | HR | 16 ² / ₃ | 196 | 16 ² / ₃ | 249 | 16 ² / ₃ | 255 | 16 ² / ₃ | 255 |
| 100 | S | 16 ² / ₃ | 196 | 25 | 166 | 25 | 170 | 25 | 170 |
| | HR | 16 ² / ₃ | 196 | 16 ² / ₃ | 249 | 16 ² / ₃ | 255 | 16 ² / ₃ | 255 |
| 130 | S | 16 ² / ₃ | 196 | 16 ² / ₃ | 166 | 16 ² / ₃ | 170 | 16 ² / ₃ | 170 |
| | HR | 16 ² / ₃ | 196 | 16 ² / ₃ | 249 | 12 ¹ / ₂ | 255 | 12 ¹ / ₂ | 255 |
| 180 | S | 12 ¹ / ₂ | 196 | 16 ² / ₃ | 166 | 16 ² / ₃ | 170 | 16 ² / ₃ | 170 |
| | HR | 12 ¹ / ₂ | 196 | 10 | 249 | 10 | 255 | 10 | 255 |
| 230 | S | 12 ¹ / ₂ | 196 | | | | | 12 ¹ / ₂ | 170 |
| | HR | 12 ¹ / ₂ | 196 | | | | | 8 ¹ / ₃ | 255 |
| Nr. Seg. | | 108 | | 93 | | 96 | | 96 | |
| Scan – W | | 107 mm | | 66 mm | | 51 mm | | 67 mm* | |

25

166

* at skinlevel
48.4°

Frame rate

Number of lines

Linear transducer – 60 Hz Norm

| depth | | SCANHEAD | | | | | | | |
|----------|----|-------------|-----|-------------|-----|-------------|-----|--------------|-----|
| | | 3.5 MHz lin | | 5.0 MHz lin | | 7.5 MHz lin | | 3.5 MHz curl | |
| 60 | S | | | 20 | 166 | 20 | 170 | | |
| | HR | | | 10 | 249 | 10 | 255 | | |
| 80 | S | 20 | 196 | 20 | 166 | 20 | 170 | 20 | 170 |
| | HR | 20 | 196 | 15 | 249 | 15 | 255 | 15 | 255 |
| 100 | S | 20 | 196 | 20 | 166 | 20 | 170 | 20 | 170 |
| | HR | 20 | 196 | 15 | 249 | 15 | 255 | 15 | 255 |
| 130 | S | 20 | 196 | 20 | 166 | 20 | 170 | 20 | 170 |
| | HR | 20 | 196 | 15 | 249 | 15 | 255 | 15 | 255 |
| 180 | S | 15 | 196 | 15 | 166 | 15 | 170 | 15 | 170 |
| | HR | 15 | 196 | 12 | 249 | 10 | 255 | 10 | 255 |
| 230 | S | 12 | 196 | | | | | 12 | 170 |
| | HR | 12 | 196 | | | | | 8 1/2 | 255 |
| Nr. Seg. | | 108 | | 93 | | 96 | | 96 | |
| Scan - W | | 107 mm | | 66 mm | | 51 mm | | 67 mm* | |

20

196

* at skinlevel
48.4°

Frame rate

Number of lines

Wobbler scanhead 50 Hz Norm

| Dept h | A and B type transducers | | | | | | C type transducers | | | | | |
|-----------|--------------------------|--------|-----|----|--------|-----|--------------------|--------|-----|----|--------|-----|
| | HR | | | S | | | HR | | | S | | |
| 60 80 | 60 | 16 2/3 | 161 | 60 | 16 2/3 | 161 | 60 | 16 2/3 | 161 | 60 | 25 | 109 |
| | 90 | 12 1/2 | 203 | 80 | 16 2/3 | 167 | 80 | 12 1/2 | 209 | 80 | 16 2/3 | 167 |
| | 105 | 8 1/3 | 255 | 90 | 12 1/2 | 203 | 90 | 12 1/2 | 203 | 90 | 16 2/3 | 163 |
| 100 | 60 | 16 2/3 | 161 | 60 | 16 2/3 | 161 | 60 | 16 2/3 | 161 | 60 | 25 | 109 |
| | 90 | 12 1/2 | 203 | 80 | 16 2/3 | 167 | 80 | 12 1/2 | 209 | 80 | 16 2/3 | 167 |
| | 105 | 8 1/3 | 255 | 90 | 12 1/2 | 203 | 90 | 12 1/2 | 203 | 90 | 16 2/3 | 163 |
| 130 | 60 | 12 1/2 | 161 | 60 | 16 2/3 | 129 | 60 | 12 1/2 | 161 | 60 | 25 | 85 |
| | 90 | 12 1/2 | 163 | 80 | 16 2/3 | 127 | 80 | 12 1/2 | 209 | 80 | 16 2/3 | 127 |
| | 105 | 8 1/3 | 255 | 90 | 12 1/2 | 163 | 90 | 10 | 203 | 90 | 16 2/3 | 137 |
| 180 | 60 | 12 1/2 | 129 | 60 | 16 2/3 | 109 | 60 | 12 1/2 | 129 | 60 | 16 2/3 | 109 |
| | 90 | 10 | 163 | 80 | 12 1/2 | 127 | 80 | 12 1/2 | 167 | 80 | 16 2/3 | 107 |
| | 105 | 8 1/3 | 255 | 90 | 10 | 163 | 90 | 10 | 163 | 90 | 16 2/3 | 117 |
| 230 | 60 | 10 | 129 | 60 | 12 1/2 | 109 | 60 | 12 1/2 | 109 | 60 | 16 2/3 | 85 |
| | 90 | 8 1/3 | 163 | 80 | 12 1/2 | 107 | 80 | 10 | 127 | 80 | 12 1/2 | 107 |
| | 105 | 7 | 211 | 90 | 12 1/2 | 137 | 90 | 12 1/2 | 137 | 90 | 12 1/2 | 137 |

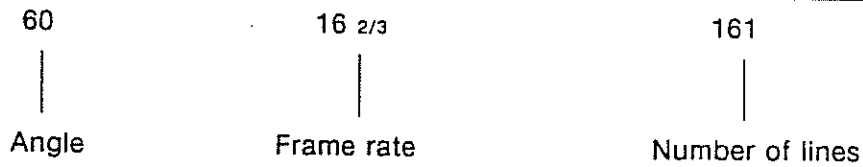

Wobbler scanhead 60 Hz Norm

| Depth | A and B type transducers | | | | | | C type transducers | | | | | |
|----------|--------------------------|-------|-----|----|----|-----|--------------------|----|-----|----|----|-----|
| | HR | | | S | | | HR | | | S | | |
| 60 80 | 60 | 15 | 161 | 60 | 20 | 129 | 60 | 20 | 129 | 60 | 30 | 85 |
| | 90 | 12 | 203 | 80 | 15 | 167 | 80 | 15 | 167 | 80 | 20 | 127 |
| | 105 | 8 1/2 | 255 | 90 | 12 | 203 | 90 | 15 | 163 | 90 | 20 | 137 |
| 100 | 60 | 15 | 161 | 60 | 20 | 129 | 60 | 20 | 129 | 60 | 30 | 85 |
| | 90 | 12 | 203 | 80 | 15 | 167 | 80 | 15 | 167 | 80 | 20 | 127 |
| | 105 | 8 1/2 | 255 | 90 | 12 | 203 | 90 | 15 | 163 | 90 | 20 | 137 |
| 130 | 60 | 12 | 161 | 60 | 15 | 129 | 60 | 15 | 129 | 60 | 30 | 75 |
| | 90 | 12 | 163 | 80 | 12 | 167 | 80 | 12 | 167 | 80 | 15 | 127 |
| | 105 | 8 1/2 | 255 | 90 | 12 | 163 | 90 | 12 | 163 | 90 | 15 | 137 |
| 180 | 60 | 12 | 129 | 60 | 15 | 109 | 60 | 15 | 109 | 60 | 20 | 85 |
| | 90 | 10 | 163 | 80 | 12 | 127 | 80 | 12 | 127 | 80 | 15 | 107 |
| | 105 | 8 1/2 | 255 | 90 | 10 | 163 | 90 | 10 | 163 | 90 | 15 | 117 |
| 230 | 60 | 12 | 129 | 60 | 15 | 85 | 60 | 15 | 85 | 60 | 20 | 75 |
| | 90 | 8 1/2 | 163 | 80 | 12 | 127 | 80 | 12 | 127 | 80 | 15 | 107 |
| | 105 | 7 1/2 | 211 | 90 | 12 | 137 | 90 | 12 | 137 | 90 | 12 | 137 |

60
|
Angle

16 2/3
|
Frame rate

161
|
Number of lines

5.5 Sigma 1 AC user/operator troubleshooting and maintenance

5.5.1 Troubleshooting

This troubleshooting procedure lists the checks for remedying simple defects. Extensive troubleshooting is explained in the technical service manual and is only performed by the local service engineer.

Check control settings. Incorrect control settings may suggest a fault that does not exist. If there is any question about the correct function of any control, consult Sections 2 and 3 of this manual.

Check connections and fuses.

Check cables for proper interconnection

Disconnect the unit from the power source and check the fuses in the power source receptacle (if the receptacle is fused).

Check monitor operation.

5.5.2 Cleaning

Clean the surface of the Sigma 1 AC with a dry cloth. If more extensive cleaning is required, switch off the instrument and disconnect the power cord. Use a slightly dampened soft cloth and very mild detergent solution to clean exterior surfaces.

Caution

Never use abrasive cleaners or steel wool. Extreme electrical disturbance may result.

With power to the Sigma 1 AC switched OFF, gently clean the transducer with a very mild detergent solution and a slightly dampened cloth. Do not apply pressure. Sterilize using non-denatured alcohol approved by KONTRON INSTRUMENTS and a soft cloth. Never immerse the transducer in any liquid.

If more extensive cleaning is required, contact your Customer Service Representative. Never use strong solvents, slosh water on the instrument, or immerse any part of the instrument in any liquid.

Never remove the protective covers of the Sigma 1 AC. Hazardous voltage levels exist.

5.5.3 Sterilization

All KONTRON INSTRUMENTS transducers may be sterilized with pills of paraformaldehyde in a metal box, at 20°C.

5.5.4 Repairs and maintenance

The Sigma 1 AC system is designed to be maintained by factory-trained Customer Service Representatives.

The manufacturer, assembler, installer or importer considers himself responsible for the effects on safety, reliability and performance of this product only if :

Assembly operations, extensions, readjustments, modifications or repairs are carried out by authorized personnel.

The electrical installation of the facility where the product is used complies with the IEC requirements or Electrical Codes of the country.

The product is used in accordance with the instructions for use.

5.6 Sigma 1 AC reference list

5.6.1 English basic system

868 000 English Sigma 1 AC Annular LSC 220 V 50 Hz 625 l., including :

- Operating manual English version.
- Freeze/TM double footswitch.
- Transducer holder Sigma 1 AC.
- 250 cc ultraphonic gel.
- Power supply cable.
- Wobbler transducer inprint-foam.

5.6.2 French basic system

869 600 French Sigma 1 AC Annular LSC 220 V 50 Hz 625 l. , including :

- Operating manual French version.
- Freeze/TM double footswitch.
- Transducer holder Sigma 1 AC.
- 250 cc ultraphonic gel.
- Power supply cable.
- Wobbler transducer inprint-foam.

5.6.3 U.S. basic system

870 900 US Sigma 1 AC Annular LSC 117 V 60 Hz 525 l. , including :

- Operating manual English version.
- Freeze/TM double footswitch.
- Transducer holder Sigma 1 AC.
- 250 cc ultraphonic gel.
- Power supply cable.
- Wobbler transducer inprint-foam.

5.6.4 Options

| | |
|---------|--|
| 834 742 | SIGMA Polaroid camera |
| 588 660 | System cart without arm |
| 581 550 | Sectorial switching box |
| 598 380 | Annular switching box |
| 585 440 | Linear switching box |
| 582 220 | External TV monitor holder arm |
| 866 504 | 75 Ohm video cable for connection of external TV monitor and/or video recorder |
| 584 320 | TM recorder cable |
| 584 770 | Double footswitch JVC/HONEYWEL |
| 862 355 | Equalization potential plug |
| 866 393 | Power supply cable ; L : 2.5 m for external TV Monitor |
| 867 381 | SIGMA 1 Service Manual |
| 587 230 | ECG kit |
| 589 780 | US ECG kit |

5.6.5 Transducers

| | |
|---------|------------------------------------|
| 597 430 | AA 3.5 MHz A transducer |
| 594 970 | AA 3.5 MHz B transducer |
| 597 740 | AA 5 MHz A transducer |
| 592 080 | AA 5 MHz B transducer |
| 597 120 | AA 7.5 MHz B transducer |
| 581 410 | 3.5 MHz C wobbler transducer |
| 856 150 | 3.5 MHz A Abdo wobbler transducer |
| 856 010 | 5 MHz B wobbler transducer |
| 583 170 | 7.5 MHz B wobbler transducer |
| 855 030 | 3.5 lin. ULAP transducer |
| 849 650 | 3.5 curl. ULAP transducer |
| 849 820 | 5 lin. ULAP transducer |
| 590 940 | 7.5 lin. ULAP transducer |
| 577 960 | Biopsy option for ULAP transducers |
| 597 880 | 7.5 MHz V Intravaginal transducer |
| 594 210 | 5 MHz R Intrarectal transducer |
| 594 490 | T shape Intra-Operative transducer |
| 594 350 | I shape Intra-Operative transducer |

5.6.6 Disposables

| | |
|---------|-----------------------------|
| 581 003 | 250 cc ultraphonic gel |
| 555 983 | Polaroid film |
| 850 608 | Roller for polaroid camera. |

5.7 External isolating transformer technical specifications

The external isolating transformer (230 V/230 V or 110V/110V) must carry the highest main supply voltage.

The external isolating transformer must have an earthed screen between input and output windings.

The external isolating transformer shall be adequately protected by fuses or thermal cut-out.

The connectors on the output winding must comply with regulations specified by the country in which the equipment is to be used.

Leakage current to ground must be less than 0.1 mA in normal condition.

Leakage current to ground must be less than 0.5 mA in single fault condition.

Isolation voltage between ground and mains live wires must be higher than 1500 V.

Addendum

Operating Note

The purpose of this Operating Note is to inform users of any known anomalies relating to Operating system.

This Note concerns the last software versions :

| Type of SIGMA | Software versions | | |
|---|-------------------|----------|----------|
| | English | U.S. | Hansmann |
| SIGMA 1AC STAR SIGMA 1AC CLASS SIGMA 1L | V1.17/C6 | V6.17/C6 | V8.17/C6 |
| SIGMA 1AC CARDIO | V3.17/C6 | V7.17/C6 | V9.17/C6 |
| SIGMA 1AC ANNULAR S SIGMA 1AC ANNULAR LS | V1.6/C6 | V6.6/C6 | V8.6/C6 |
| SIGMA 1 AC ANNULAR C | V3.6/C6 | V7.6/C6 | V9.6/C6 |

- When using a 7.5 MHz S transducer and switching any other sectorial transducer, the size of displayed image could be reduced.
In this case press SET I.

Specifications of acoustic power output

The maximum power available to be delivered to the transducer is given in the following table :

| Application | I_{spta} (mW/cm ²) |
|-------------|----------------------------------|
| Cardiac | 430 |
| Abdominal | 94 |

