

**ALOKA ECHO CAMERA Model SSD-500  
OPERATOR'S MANUAL**

Manual No.: MN1-0346

Effective software version: 5.0

(S/N : 01M7401 onward)

Issued on August 27, 1990

**ALOKA CO., LTD.**

## TABLE OF CONTENTS

	PAGE
1. ALOKA SSD-500 FEATURES .....	1-1
2. SAFETY INSTRUCTIONS .....	2-1
3. SPECIFICATIONS .....	3-1
4. NAME AND FUNCTION OF CONTROLS .....	4-1
4.1 External View .....	4-1
4.2 Front Side Controls .....	4-2
4.3 Operation Panel Controls .....	4-4
4.4 Rear Panel Controls .....	4-10
5. MENU FUNCTIONS .....	5-1
6. LET'S GET STARTED .....	6-1
6.1 Installation .....	6-1
6.2 Turning On Power .....	6-3
7. B-MODE IMAGING .....	7-1
7.1 Introduction .....	7-1
7.2 Adjustment of Image .....	7-3
7.3 Useful Functions for B-mode Imaging .....	7-5
7.4 Displaying Body Mark .....	7-10
7.5 Dual B-mode Display .....	7-12
8. M-MODE IMAGING .....	8-1
8.1 Introduction .....	8-1
8.2 Adjustment of Image .....	8-2
8.3 Useful Functions for M-mode Imaging .....	8-4
9. BASIC MEASUREMENTS .....	9-1
9.1 Distance .....	9-1
9.2 Area/Circumference .....	9-3
9.3 Velocity .....	9-6
9.4 Heart Rate .....	9-8
9.5 Angle .....	9-10
9.6 Ratio .....	9-12

10.	GESTATIONAL AGE CALCULATION .....	10-1
10.1	Introduction .....	10-1
10.2	Indicator Method .....	10-2
10.3	Gestational Age Calculation by Parameter Method .....	10-6
10.4	Fetal Growth Tables .....	10-12
11.	FETAL WEIGHT ESTIMATION .....	11-1
11.1	Introduction .....	11-1
11.2	Shepard Method .....	11-3
11.3	Hadlock Method .....	11-5
12.	CHARACTER DISPLAY .....	12-1
13.	RECORDING IMAGE .....	13-1
13.1	VCR Recording .....	13-1
13.2	Thermal Printer (SSZ-300) .....	13-2
13.3	Polaroid Camera Unit (SSZ-108U-P) .....	13-4
13.3	SLR Camera Unit (SSZ-108-35) .....	13-5
14.	TROUBLE SHOOTING .....	14-1
14.1	Error Message .....	14-1
14.2	How to Cope with Trouble .....	14-2
14.3	Calling Service Person .....	14-3

INDEX

---

Section 1

**FEATURES**



## 1. ALOKA SSD-500 FEATURES

The ALOKA ECHO CAMERA model SSD-500 is a portable linear/convex sector ultrasound scanner. It is compact in size and light in weight, yet it provides superb image quality as good as more expensive, bulky system.

Imaging mode include single B mode, dual B mode, B and M simultaneous display mode and single M mode.

Measurements include distance, area, circumference and M-mode slope (velocity, time and dimension).

Calculations for gestational age and fetal weight are built-in features.

The basic system can be used for general abdominal imaging and OB/GYN imaging.

A variety of optional probes are available for extending the area of clinical diagnosis to intraoperative, small parts, cardiac, transvaginal and transrectal imaging and biopsy.



---

## Section 2

# SAFETY INSTRUCTIONS





---

## 2. SAFETY INSTRUCTIONS

\* To operate the equipment correctly and safely, observe the cautions listed below.

1. Use this equipment only for the designated purposes.

Type of protective method and degree against electrical shock of this equipment is class I type BF. Since the type is not CF, you must not apply this equipment directly to the heart.

2. Only qualified physicians and sonographers may operate the equipment.

3. Choose a good location for equipment operation as follows:

- (1) The place must be dry and free from any water intrusion.
- (2) Avoid direct sunlight, sudden temperature or humidity change, dust, salt, chemicals, and any other contaminants.
- (3) Do not tip, shake, or shock the equipment, not even during transportation.
- (4) Make sure the power supply has the correct voltage and sufficient capacity.
- (5) Do not locate the equipment near a power generator room, X-ray equipment, or in any other place where there is electrical noise.
- (6) Arrange all connecting cables and wires out of the way so that people cannot trip over them.

4. Before operating the equipment, observe the cautions below.

- (1) Make sure that the power switch is in the OFF position before connecting the power plug to a power outlet.
- (2) Check the connecting cables and cords. And check the setting of switches and controls, to assure valid operating status of the equipment.
- (3) Use with other electronic equipment may hinder the full capabilities of this equipment. Take care in advance to avoid such a situation.

## 2. SAFETY INSTRUCTIONS

---

5. During equipment operation, observe the cautions listed below.
  - (1) Be alert to any abnormality in the equipment, or in the patient.
  - (2) If you notice an abnormality, promptly stop equipment operation in a manner safe to the patient and take whatever action is necessary.
  - (3) Don't let the patient touch the equipment main unit.
  
6. Following equipment operation, observe the cautions listed below.
  - (1) Restore the original setting of the operating switches, knobs and controls and then switch the power off.
  - (2) When disconnecting cables from sockets, hold the plug, not the cable.
  - (3) To make the equipment and accessories ready for the next patient, properly clean them and then store in an orderly manner.  
For cleaning the equipment, use soft dry cloths. To remove soil, if necessary, use a soft cloth moistened with a neutral detergent or alcohol.
  
7. If you notice a malfunction, immediately post an adequate caution tag (for example, noting "Under repair. Do not use.") on the equipment and contact our distributors for repairs.
  
8. Never under any circumstances, modify, remodel, or otherwise rework the equipment.
  
9. Maintenance and Inspection  
When operating equipment left unused for a long time, be sure to check the equipment to assure normal and safe operation.
  
10. Charging Battery

In the equipment, the clock for date and time display is powered by the incorporated battery. Apply power to the equipment for about eight hours a week, even when the equipment is not being operated for a long period.

If date is not displayed, apply power to the unit for about 15 hours continuously.

### CAUTIONS WHEN USING THE PROBE:

- (1) The probe is easily affected by shock. In particular, the patient contact area is easily damaged by bumping, so use extreme care.
- (2) Do not immerse the entire probe in water or other liquids.
- (3) Avoid roughly bending or pulling the cable as this may break it.
- (4) After using the probe, wipe off the ultrasound gel. To clean the probe, use a neutral detergent or alcohol. Always keep the probe clean.
- (5) To clean the probe after use, wash the head with water and wipe with a soft material such as gauze or sponge, or wash in running water. Do not use a stiff brush.
- (6) To sterilize or disinfect the intraoperative probe after use, clean its scan head then disinfect the probe as shown below.
  - a) Gas (\*1)  
Formalin gas or ethylene oxide gas  
\*1 Use below 55°C
  - b) Medical liquid (\*2)

Hibitane™, Isodine™, Detergicide™ or Purelox™

Soak the probe in one of the above liquids for several minutes and completely wash the soaked part.

\*2 Do not immerse the connector plug.

Note 1: Do not autoclave or boil the probe.

Avoid decompressing/pressurizing the probe.

Note 2: Before performing gas sterilization, seal the connector plug against the gas by using a plastic bag.

Note 3: Do not apply liquid to the connector plug for cleaning or other purposes. (The connector is not waterproof.)



---

**Section 3**

**SPECIFICATIONS**



---

### 3. SPECIFICATIONS

Scanning method:	Electronic convex sector Electronic linear (option)
Display mode:	B-mode Dual B-mode M-mode B/M mode
Standard probe (model UST-934N-3.5)	
Scanning method:	Electronic convex sector
Ultrasound frequency:	3.5 MHz
Angle of view:	60°
Radius of curvature:	60 mm
Maximum display depth:	22 cm
STC:	NEAR and FAR
Image magnification	
In B, dual B, and M modes:	×0.75, ×1.0 and ×1.5, three steps changeable
In B/M mode:	×1.0
Focal points in transmission:	Maximum 4 points selectable
M-mode	
Display method:	Moving bar
Sweep speed:	4 seconds per full screen
Sampling cursor:	Controlled through menu function
Characters and graphic display	
ID	10 characters × 2 lines
Date & time:	Automatic (3 formats selectable)
Focal point:	Automatic (F1 - F4)
Probe frequency:	Automatic
Gain value:	Automatic (GAIN, NEAR and FAR)
Comment in image area:	40 characters × 28 lines
Measurement value:	Automatic when measurement is performed
Image serolled position:	Automatic
Others:	Distance scale mark, image orientation mark, puncture guide line (on/off, possible), M-mode sampling cursor, M-mode time mark, body mark
Image memory capacity:	512 × 512 × 6 bit



### 3. SPECIFICATIONS

---

Gray shades:	64 levels
Image orientation:	Laterally (right/left) and longitudinally (up/down) available (B-mode only)
Image polarity:	White-on-black or black-on-white, selectable
B-mode image vertical scrolling:	Possible for linear image only
Measurement and calculation functions	
Caliper control:	Joypad (standard) or trackball (option)
Measuring item:	Distance, area, circumference, M-mode slope (velocity, time and dimension), 2 channels each
Calculation item:	Gestational age and fetal weight, by built-in calculation expression (USA, Europe, Tokyo University or Osaka University method, predetermined by the internal circuit**)
Video system:	525 lines/frame, 30 frames/sec or 625 lines/frame, 25 frames/sec
Viewing monitor:	7-inch diagonal
Power requirement:	115/220 Vac $\pm$ 10%, 50/60 Hz, 90VA
Size of main unit:	Approx. 29 cm (W) $\times$ 25 cm (D) $\times$ 32 cm (H)
Weight:	Approx. 10 kg (Main unit only)

\* The specifications may be subject to change without notice for improvement.

\*\* Change of the gestational calculation method may be done only by authorized service personnel.

## Standard Components

Description	Quantity
Imaging unit (main unit)	1
Probe, model UST-934N-3.5	1
Probe holder	1
Power Cable	1
Grounding wire	1
Ultrasound gel	1 bottle
Operation manual	1
Accessories (Spare fuse, Overlay sheet, PCB list, Installation manual)	1 set



---

## Section 4

# NAME AND FUNCTION OF EACH CONTROL

Function of each control is briefly described. Actual operating procedures are explained in the later sections.



4. NAME AND FUNCTION OF CONTROLS

4.1 External View

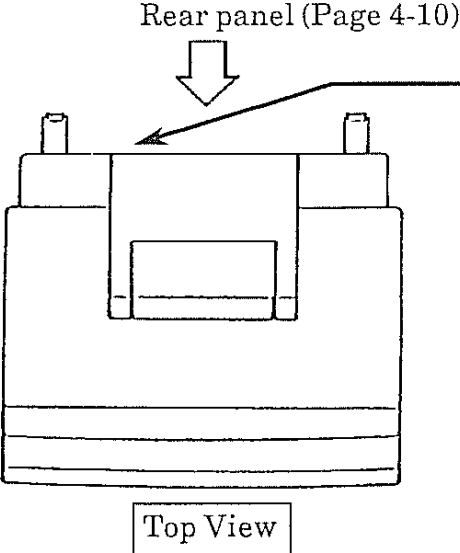

NOTE: Power switch is on the rear of the unit.

\* The page number in the parenthesis indicates the page that starts explanation.

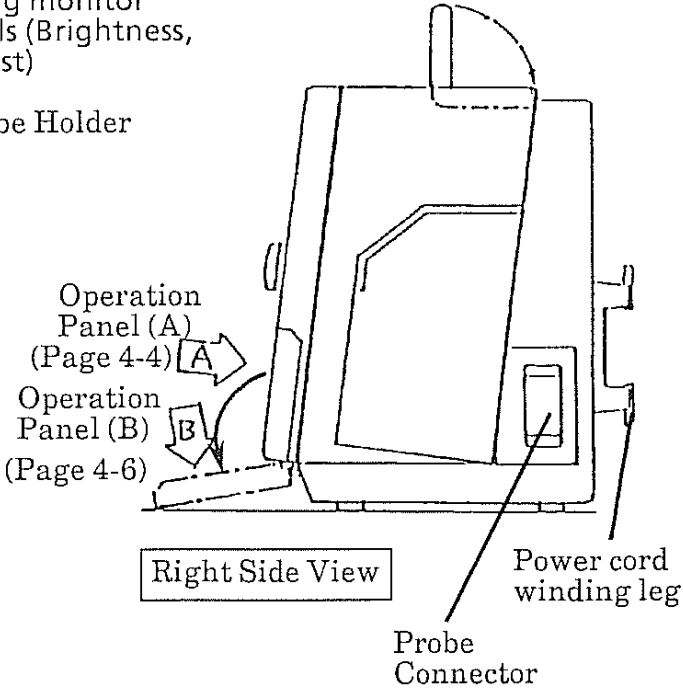
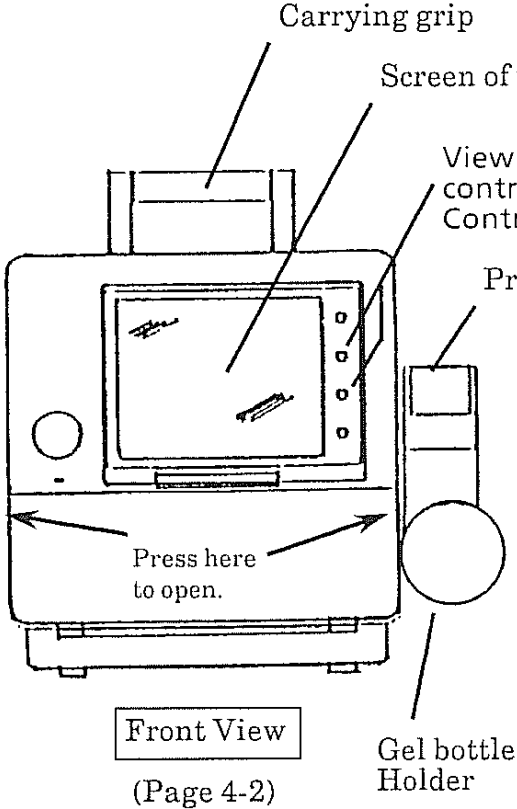



### 4.2 Front Side Controls

**(1) Power Indicator**

Lights when power is applied to this unit.

**(2) GAIN control**

Adjusts the sensitivity (brightness) of the ultrasound image viewed on the screen.  
This controls brightness of both B-mode and M-mode images.

To increase the brightness, turn this control clockwise

**(3) BRIGHTNESS control**

Adjusts brightness of the viewing monitor.  
\* Adjusted at the factory. Do not adjust needlessly.

**(4) CONTRAST control**

Adjusts the contrast of the viewing monitor.  
\* Adjusted at the factory. Do not adjust needlessly.

**(5) Photography hood mounting holes**

Optional camera hood model ACR-500 can be fit using these holes as guides.  
Align the protrusions of the photography hood and these holes for fitting.  
If the switch in the hole is not pressed by the hood, brightness is not adjusted for photographing.

**(6) Menu selection switches**

To select an item in a menu displayed on the screen.  
Press the corresponding switch for selecting the desired item.  
**SEE SECTION 5. MENU FUNCTIONS** for the detailed explanation.

(Example of menu)

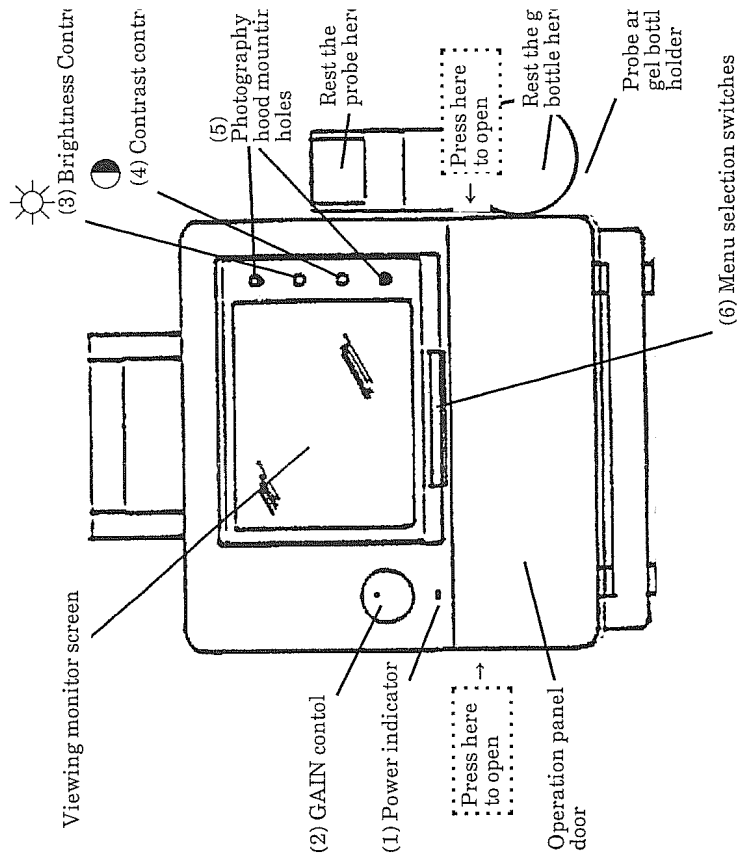
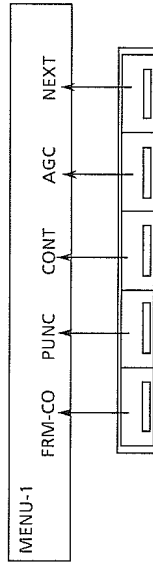



## 4.3 Operation Panel Controls

\* Unfold the page 4-9 for the figure of the panel.

### Operation Panel (A)

#### (7) Joypad

Moves caliper mark (+ or ×) in the direction of the pressing.  
The caliper mark can be moved up/down, right/left or diagonally.  
The caliper mark moves faster if you keep pressing it.

#### Joypad Function selector switches (8) to (13)

#### (8) POSITION (\* This works only when linear probe is used.)

Shifts image display range. The lower area that is not shown on the screen can be displayed by scrolling up the image.  
→SEE PAGE 7-6 for the operation.

#### (9) BODY MARK

Displays body mark menu of the selected body mark group.  
→SEE PAGE 7-10 for the operation.

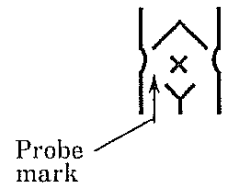

Body mark

#### (10) MEASUREMENT switches

Pressing the switch enables each measurement.



: Area measurement switch.  
→SEE PAGE 9-3 for the operation.



: Distance measurement switch.  
Distance in B-mode and velocity in M-mode can be measured.  
→SEE PAGE 9-1 for distance measurement.  
→SEE PAGE 9-6 for M-mode velocity measurement.

#### 4. NAME AND FUNCTION OF CONTROLS

##### 4.3 Operation Panel Controls

---

###### (11) CALIPER MARK switches



: + caliper switch. Measurement is possible by the + caliper mark.



: × caliper switch. Measurement is possible by the × caliper mark.

The caliper marks are displayed when measurement is performed.

Distance or M-mode velocity measurement can be performed just by pressing the switch by each caliper mark.

###### (12) MARK REF switch

Used for marking points for measurement.

###### (13) Probe mark rotation switches



: CCW (counterclockwise) switch. Rotates probe mark counterclockwise.



: CW (clockwise) switch. Rotates probe mark clockwise.

##### STC control group (14) to (16)

###### (14) NEAR GAIN switches

Controls gain (brightness) in the near field (close to the skin) of the ultrasound image.

↑ : Increases gain in the near field.

↓ : Decreases gain in the near field.

###### (15) FAR GAIN switches

Controls gain (brightness) in the far field (far from the skin) of the ultrasound image.

↑ : Increases gain in the far field.

↓ : Decreases gain in the far field.

(16) **MAGNIFICATION** switches

Changes image magnification (B-mode and M-mode images) in three steps: x0.75, x 1.0, and x1.5.



: Reduces image.



: Magnifies image.

**NOTE:** Magnification of B/M mode image cannot be changed.

**OPERATION PANEL (B)**

(17) **PRINT** switch

To print image by the optional photography unit (SSZ-300).

When optional printer model SSZ-300 is connected with this unit, ultrasound image can be recorded by pressing this switch.

(18) **MENU** switch

The menu is a list of functions displayed on the screen.

→**SEE SECTION 5.** "Dictionary of Menu Functions" for the detail.

(19) **FOCUS** switch

Displays menu for selecting focal zone.

→**See PAGE 7-8** for the detailed explanation of the function.

(20) **OB CAL** switch

Obstetrical calculation switch. Gestational age, expected date of confinement can be calculated.

→**SEE SECTION 10.** GESTATIONAL AGE CALCULATION.

(21) **FETAL WEIGHT** switch

Estimated fetal weight can be calculated.

→**SEE SECTION 11.** FETAL WEIGHT ESTIMATION.

#### 4. NAME AND FUNCTION OF CONTROLS

##### 4.3 Operation Panel Controls

(22) BODY MARK menu switch



Pressing the switch displays the BODY MARK GROUP menu as shown below on the screen.

The desired body mark group can be selected by the menu.

→See PAGE 7-10 "7.4 Displaying Body Mark" for the operation.

BODY MARK GROUP	ABDOM	OBST	HEAD	OTHER
-----------------	-------	------	------	-------

(23) MODE selection switches

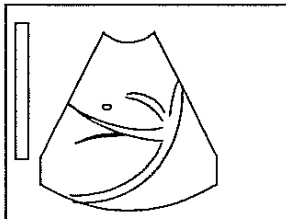

B mode

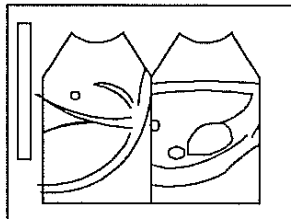

Dual B mode

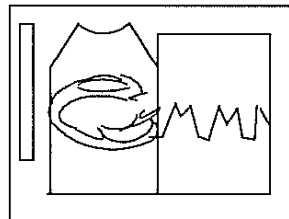

B/M mode

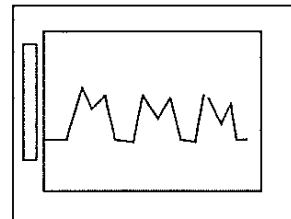

M mode

- B : Displays a B-mode image.
- B|B : Displays two B-mode images side by side.
- B/M : Displays B-mode image and M-mode image side by side.
- M : Displays an M-mode image.

(24) IMAGE DIRECTION switch

Changes lateral display direction of B-mode image.  
 When the switch is off, the direction is normal (→).  
 The FRONT mark on the probe and the direction mark (→) of the image points in the same direction.  
 When the switch is on, the direction is reversed (←).  
**SEE PAGE 7-5.**

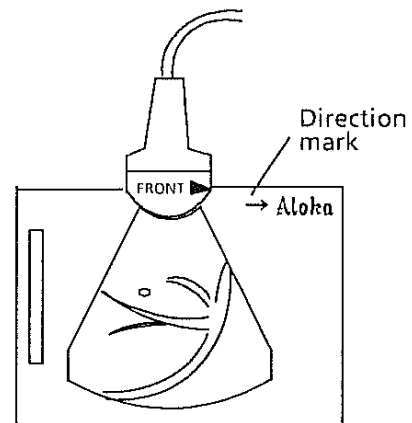

(25) **FREEZE** switch

To obtain a still image.

(26) Alphanumeric Keyboard

**ID (Identification) switch:** Press this to enter patient identification in the ID area.

**COMMENT:** Press this to enter comments in the image area.

**NEW PATIENT:** All the settings of functions are initialized.

**BS (Back Space) key:** Erases the character at the cursor. The cursor goes back.

**RTN (Return):** Shifts the cursor to the left end of the next line.

**AC (All Clear):** Erases all the characters displayed in the image area or ID area. When the cursor is in the image area, all the characters in the image area are erased.

When the cursor is in the ID area, all the characters in the ID area are erased.

**SPACE:** Makes a space and erases characters at the cursor. The cursor moves to the right.

**SHIFT:** Displays uppercase symbol of each key.

←: Shifts character cursor to the left while character at the cursor is not erased.

→: Shifts character cursor to the right while character at the cursor is not erased.

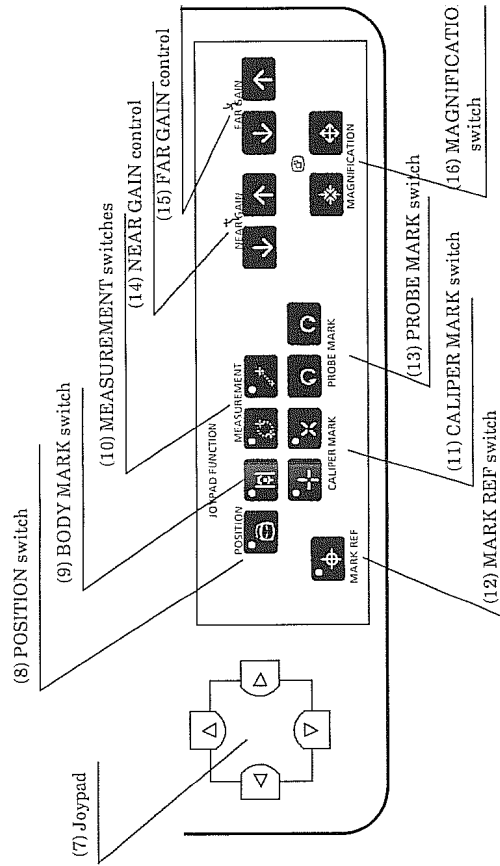

Operation Panel (A)

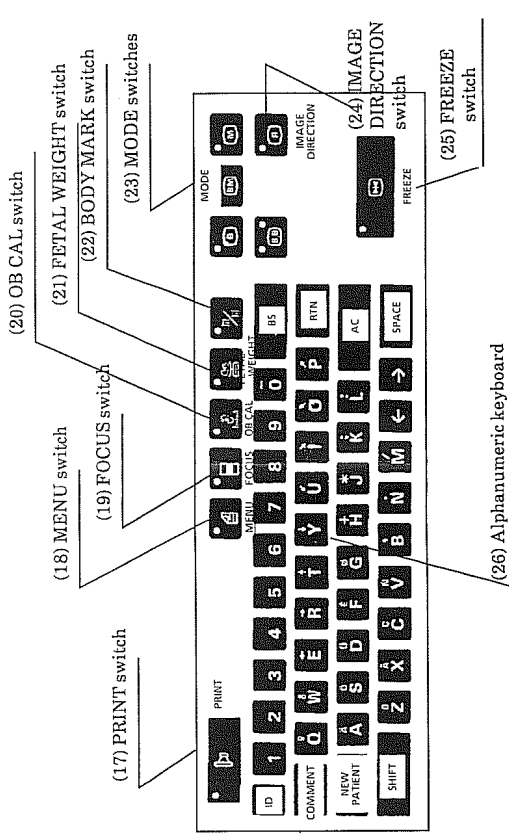

Operation Panel (B)

### 4.4 Rear Panel Controls

(27) Brightness Adjuster for Photography

\* Adjusted at the factory. Do not adjust needlessly.

(28) Contrast Adjuster for Photography

(29) Connector for optional printer SSZ-300  
Connects remote control cord.

(30) Connector for optional trackball unit

(31) Connector for optional footswitch

(32) Video Source selector

When observing images from a video tape recorder, set the selector to EXT (up).  
After the observation of VTR image, return the switch to INT (down).

NOTE: When no VTR is connected and this switch is set to EXT, no image appears on the screen.

(33) Video signal connectors

Upper connector accepts video signal. (VIDEO IN)

Lower connector generates video signal. (VIDEO OUT)

(34) Power Switch

Press the I side to turn on the power.

Press the O side to turn off the power.

(35) Power cord connector

Connect the attached power cord.

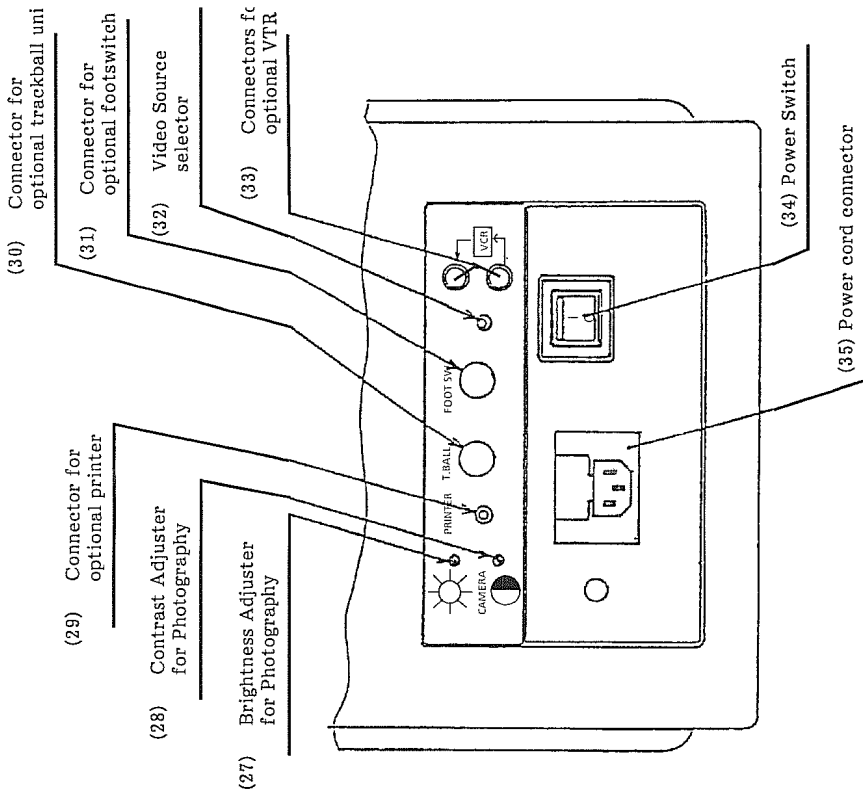

## Section 5

# MENU FUNCTIONS

This section contains descriptions of the functions that are controlled by menu. In this section, the words (abbreviations) that represent the functions are arranged in alphabetical order. You can look up the item you want in the same way as in a dictionary.

	Page
AGC	5-4
CONT (Contrast)	5-4
DATE (DATE & TIME)	5-5
DT-DSP (DATA DISPLAY)	5-7
FRM-CO (Frame Correlation)	5-8
IMG-DI (Image Direction)	5-9
IMG-PO (IMAGE POLARITY)	5-10
PUNC (Puncture Guide Line)	5-11

NOTE1: H-RATE (Heart Rate measurement) is explained on page 9-8.

NOTE2: The FOCUS menu is explained on page 7-8.

Menus are also displayed when measurement is in process. See sections 9 to 11 for the measuring operation.

NOTE3: The BODY MARK GROUP menu is explained on page 7-10.





## 5. MENU FUNCTIONS

### Introduction

<How to use menus>

- a. A menu is displayed when you press the **MENU** switch on the operation panel B.

A menu is displayed at the bottom of the screen.

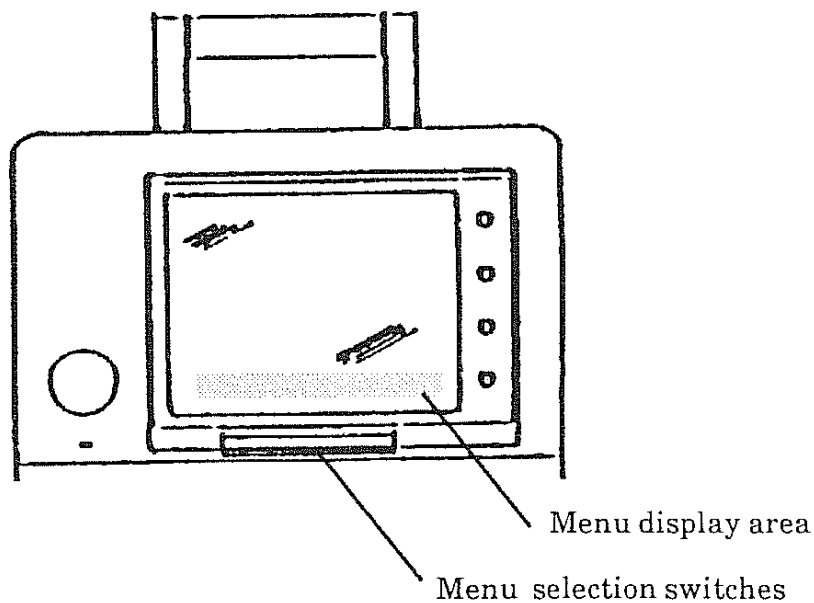

- b. Selection of a function is done by the menu selection switches below the screen.

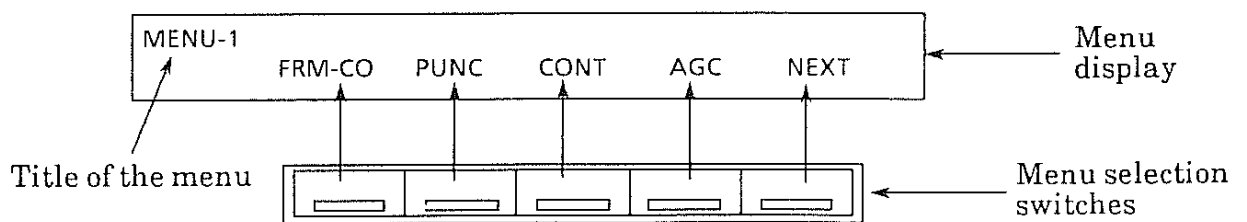

- c. Press the switch just below the menu item you want to select.

**NOTE:** The menu is erased by pressing the **MENU** switch again.

## 5. MENU FUNCTIONS

### Introduction

#### <MENU PAGES>

There are three pages in each mode. The first page is common to all the modes .  
To turn the page, select **NEXT** in the menu.

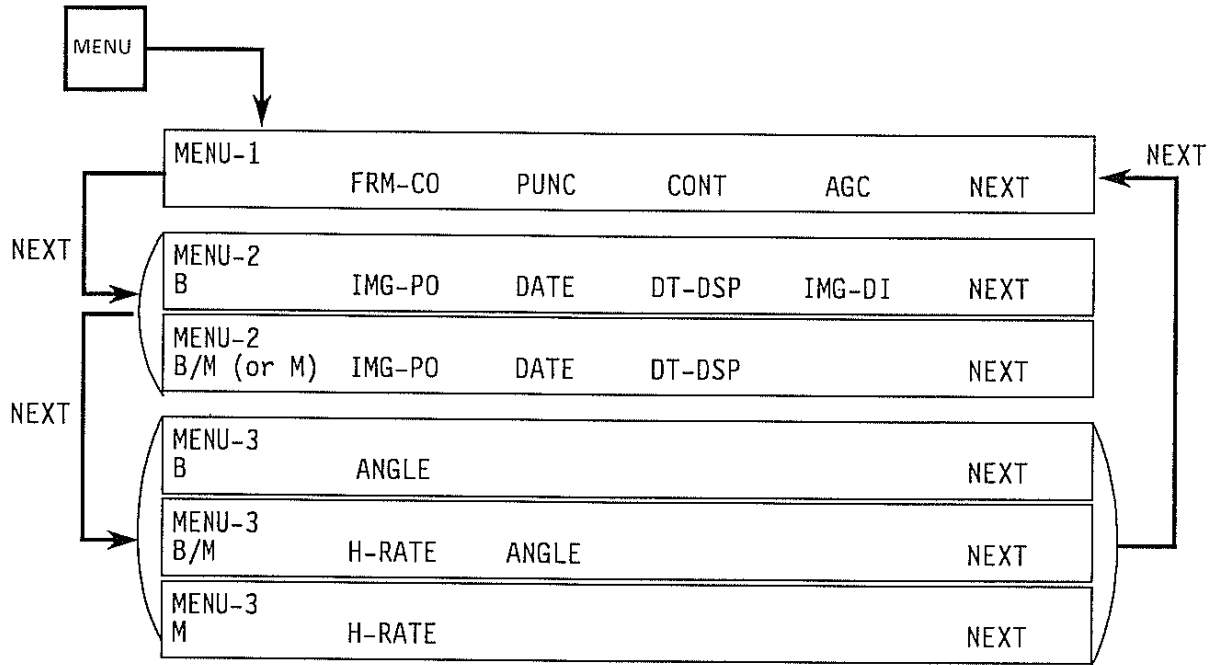

#### <CONTENTS OF MENU>

Menu Item	Full spelling	Page
AGC		5-4
CONT	Contrast	5-4
DATE	Date & time	5-5
DT-DSP	Data display	5-7
FRM-CO	Frame correlation	5-8
H-RATE*	Heart rate	9-8
IMG-DI	Image direction	5-9
IMG-PO	Image polarity	5-10
PUNC	Puncture guide line	5-11

\* Heart rate measurement is explained in section 9 together with other measurement procedures.

## How to read this section

The items of menus are arranged in alphabetical order.

On each page, explanation is made in the following format:

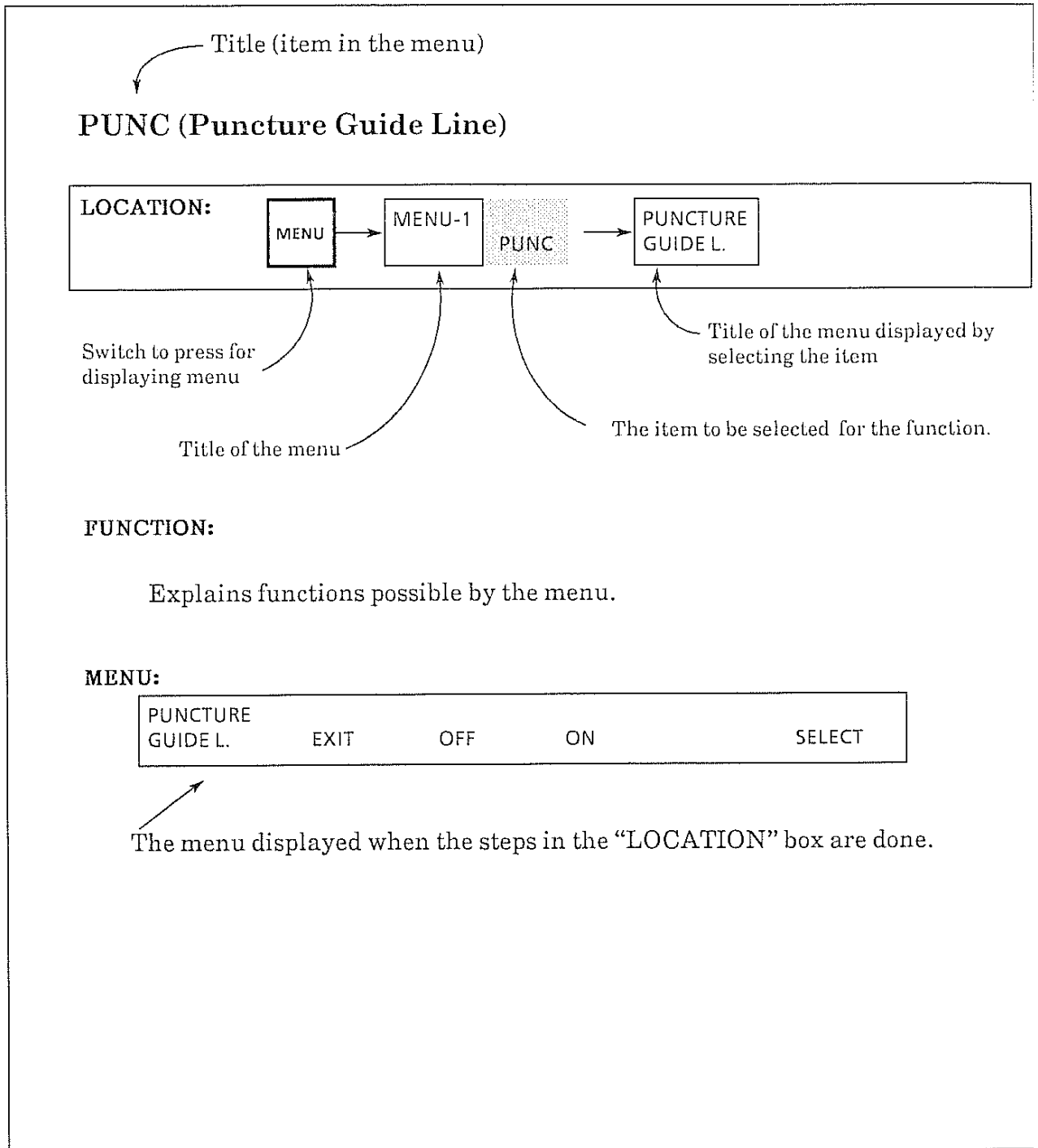

5. MENU FUNCTIONS  
AGC, CONT

---

**AGC**

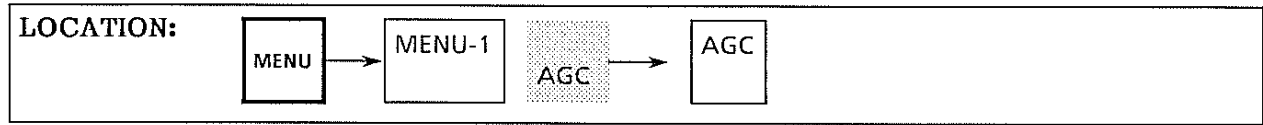

**FUNCTION:**

Enhances outline of tissue echo.

**MENU:**



- EXIT: Returns to MENU-1 display.
  - ↓: Decreases AGC effect.
  - ↑: Increases AGC effect.
  - RESET: Returns to normal state and no AGC processing is applied.
- 

**CONT**

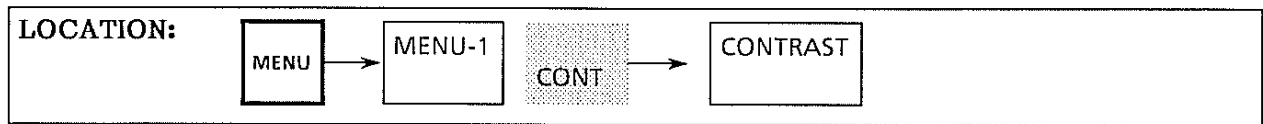

**FUNCTION:**

Changes contrast of ultrasound image. It changes contrast of B-mode and M-mode images in common.

**MENU:**



- EXIT: Returns to MENU-1 display.
- ↓: Decreases contrast.
- ↑: Increases contrast.
- RESET: Returns to predetermined contrast.

**DATE (Date & Time)**

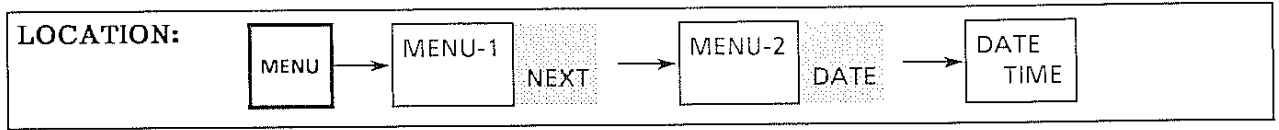

**FUNCTION:**

Setting of date and time is possible. Once the date and time are set, the incorporated clock automatically updates the date and time display.  
The date is used for gestational age calculation. Confirm that the correct date is displayed before starting the calculation.

**MENU:**

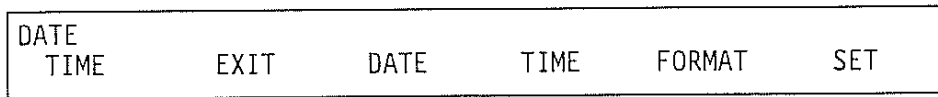

**EXIT:** Returns to MENU-2 display.

**DATE:** Corrects date. (See next page for the setting procedure.)

**TIME:** Corrects time. (See next page for the setting procedure.)

**FORMAT:** It is possible to select date format.  
The following three formats are set in order by pressing the corresponding menu selection switch:

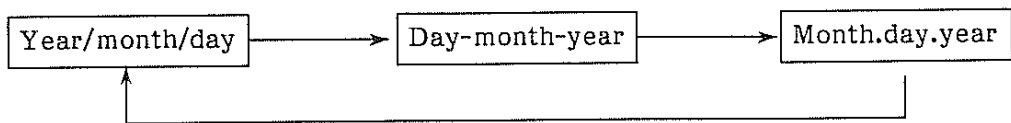

**SET:** Used to start the clock from the corrected time.

(To be continued)

## 5. MENU FUNCTIONS

### DATE

---

#### STEP:

<Date>

- a. Select **DATE** in the menu. Character cursor shifts to DATE area.
- b. Enter date from the keyboard according to the date format as follows:

**NOTE:** Do not enter separation symbols (-, . and /) as they are automatically entered.

DD is for day, MM is for month, YY is for year. (Use two digits each.)

Date display format	Example	Keys to be pressed
DD-MM-YY	16 January, 1989	160189
MM.DD.YY	January 16, 1989	011689
YY/MM/DD	1989, January 16	890116

- c. Select **SET** in the menu.

<Time>

- a. Select **TIME** in the menu.
- b. Enter time from the keyboard.

(Example)

When the present time is 5:24 and some second pm, press keys in the order of 172500. The entered time is displayed.

- c. At 17:25 exactly, select **SET** in the menu. The clock starts from the entered time.

#### NOTE:

The incorporated clock is powered by rechargeable battery and automatically charged while power is applied to the unit. If the date and time are not displayed, the battery may have gone flat.

## DT-DSP (Data Display)

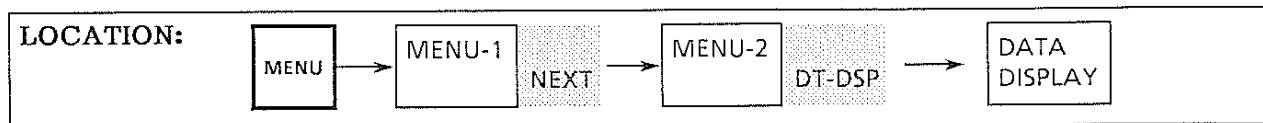

**FUNCTION:**

Displays or erases data display (equipment parameters) on the screen.

The following data can be erased or displayed.

Item	Example
Probe frequency:	3.5M      3.5 MHz
Gain setting value:	G60
Near field gain:	N-24
Far field gain:	F0.9

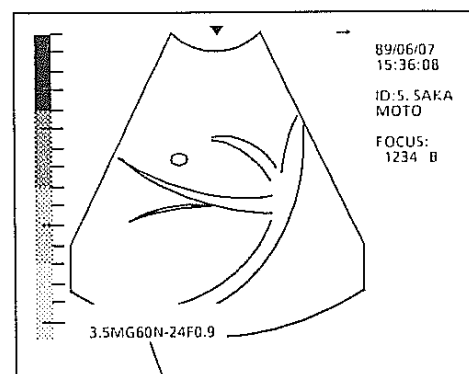

Data display (Equipment parameters)

**MENU:**



**EXIT:** Returns to MENU-2 display.

**OFF:** Erases data display.

**ON:** Displays data display.

5. MENU FUNCTIONS  
FRM-CO

FRM-CO (Frame Correlation)

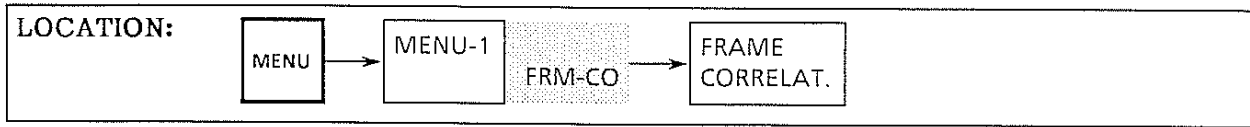

<FUNCTION>

Turns on/off the frame correlation\*.

1. When the frame correlation is on, movement of an image leaves a faint trace behind it as if persistence of vision is provided.
2. When the frame correlation is turned off, no persistence of vision is observed. Therefore, this setting is suited for observing fast moving object such as the heart.

<MENU>



- EXIT: Returns to MENU-1 display.  
OFF: Turns off the frame correlation.  
ON: Turns on the frame correlation.  
AUTO: Frame correlation is turned on or off automatically according to the probe used.

<How to use>

Usually set the menu to AUTO.

Setting of on/off of frame correlation is predetermined so as to suit the purpose of diagnosis of each probe. For example, as optional probe UST-944B-3.5 is for cardiac imaging, the setting is off (in the case of one point focus). If you use the probe for another purpose such as abdominal imaging, turn the frame correlation on.

<Initial setting>

AUTO



## IMG-DI (Image Direction)

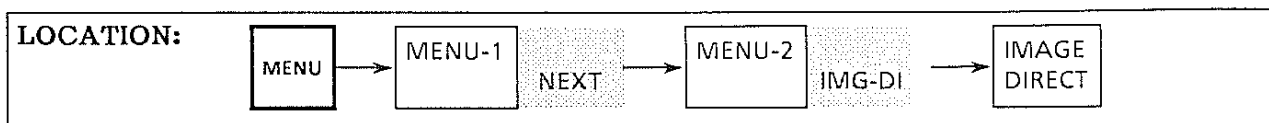

**FUNCTION:**

Turns a B-mode image upside down.

**MENU:**

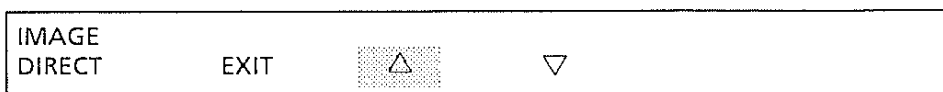

**EXIT:** Returns to MENU-2 display.

△: Displays normal direction image.

▽: Displays upside down image.

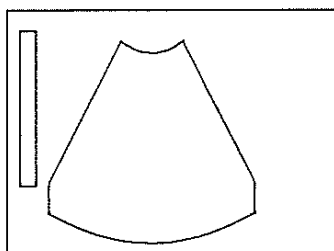

NORMAL

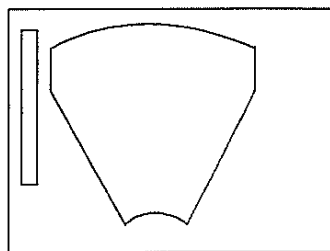

UPSIDE DOWN

**NOTE:** In dual B (B{B) mode, both left and right images are reversed at the same time. Independent image reverse is impossible.

5. MENU FUNCTIONS  
IMG-PO

**IMG-PO (Image Polarity)**

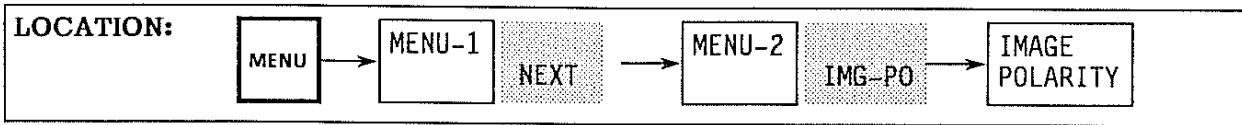

**FUNCTION:**

Reverses the black and white of the display on the screen.

**MENU:**

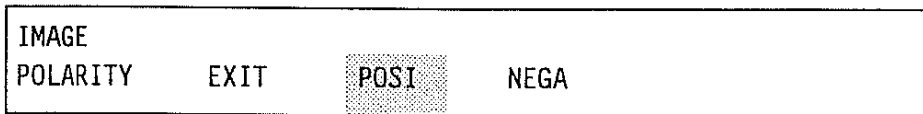

- 1 EXIT: Returns to MENU-1 display.
- 2 POSI: White-on-black image is displayed.
- 3 NEGA: Black-on-white image is displayed.

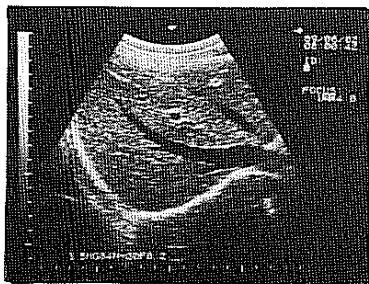

Photo 5-1 POSI image

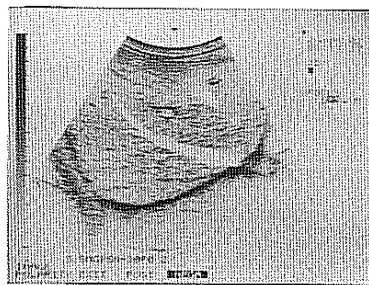
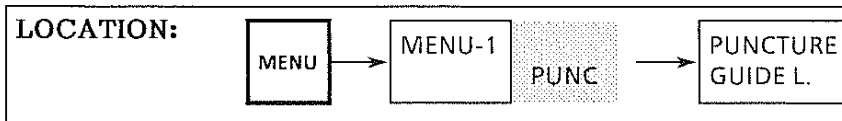

Photo 5-2 NEGA image

**INFORMATION:**

Image polarity of video signal output from video signal connector (33) is also changed by this setting.

## PUNC (Puncture Guide Line)



**FUNCTION:**

Turns on/off a puncture guide line display on a B-mode image.

The guide line shows the path of an inserted needle when proper puncture probe or puncture adapter is used.

The guide line differs from probe to probe. This unit automatically displays a guide line that suits the probe used for scanning.

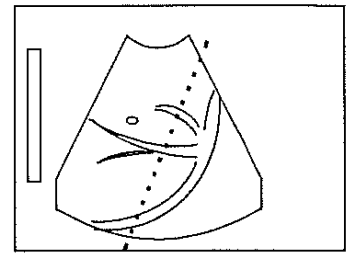

Puncture guide line

**MENU:**



**EXIT:** Returns to MENU-1 display.

**OFF:** Erases the puncture guide line.

**ON:** Displays the puncture guide line.

**SELECT:** When the puncture tool can set two different insertion angles, select the guide line which is to be used.

**NOTE:**

The puncture guide line is displayed only in B mode.

B-mode position shift is impossible while the guide line is displayed.

For the detail of handling puncture adapter or puncture probe, see the operation manual of each item.



**Section 6**

**LET'S GET STARTED**



---

## 6. LET'S GET STARTED

### 6.1 Installation

#### (1) Location

a. Safety Instructions

Read Section 2. SAFETY INSTRUCTIONS, item 3. "Choose a good location for equipment operation as follows:" (page 2-1) for the location.

b. Transportation

To carry the unit by hand, hold the grip firmly.  
Do not bump the unit.

When using the optional cart, unlock the caster stopper before moving.  
Do not tip, shake, or shock the cart.  
Lock the caster stopper to stabilize the cart.

#### (2) Environmental Condition

The unit must be used within the range of the following conditions:

Temperature: 10°C to 40°C  
Relative humidity: 30% to 75%

When the unit is used beyond the above conditions, the electrical components may be damaged.

Avoid also direct sunlight, and sudden changes in temperature and humidity.

#### (3) Size of the Unit

The unit is 290 mm (width) × 250 mm (depth) × 320 mm (height).

6. LET'S GET STARTED  
6.1 INSTALLATION

---

(4) Connection of probe

- a. Turn the lock lever fully counterclockwise to point the arrow mark to RELEASE.
- b. Directing the cable side upward, insert the connector straight into the receptacle.
- c. Turn the lock lever clockwise till it stops and the arrow mark points to LOCK.



a

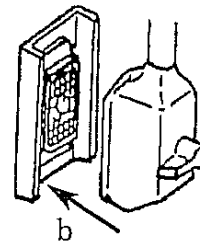

b

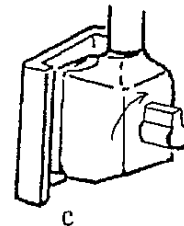

c

(5) Connection of Power Cord

- a. Confirm that the power switch is at the OFF position.
- b. Connect the power cord to the unit.



## 6.2 Turning On Power

Confirm the power cord and probe connection.

### <Turning on the power>

- a. Turn on the power switch.

A message appears and blinks on the screen for several seconds during system set-up. The message shows the system software.

(Example of message)

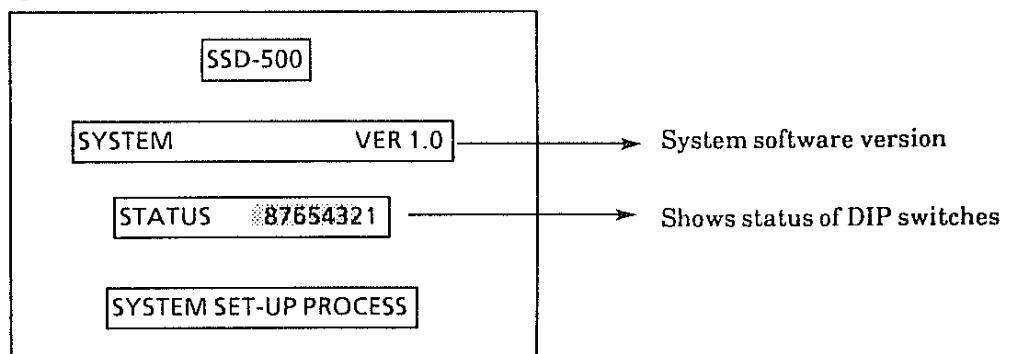

- b. When the system set-up is completed, the message disappears and the initial image display format appears. The initial display mode is B mode.

### <Date and time display>

- c. Confirm the date and time display. If they are not correct, set them for local date and time.  
→See PAGE 5-5 for the procedure.

NOTE: The gestational age calculation is based on the displayed date.

### <ID input>

- d. The character cursor ( ■ ) is in the ID area. Enter patient identification number or name using the keyboard. Up to 20 characters can be entered in the ID area.

It is possible to enter characters in the image area.  
For details of character display see section 12.

## 6. LET'S GET STARTED

### 6.2 Turning On Power

---

#### <Initial setting>

##### Back-up function:

When the power is turned on, various equipment parameters (e.g. display mode, magnification, and menu functions) are automatically set to the last conditions just before the power is turned off.

##### Initialization Function

Pressing the **NEW PATIENT** key resets the conditions to those when the power is turned on.

#### <Backed up parameters>

The following conditions are controlled by the back-up function and initialization function:

MODE (Display mode)  
MAGNIFICATION  
STC (NEAR and FAR)  
FRAME CORRELATION  
PUNCTURE GUIDE LINE  
CONTRAST  
AGC  
IMAGE POLARITY  
DATE DISPLAY FORMAT  
DATA DISPLAY  
IMAGE DIRECTION ( $\Delta$ ,  $\nabla$ )  
FOCUS B, B/M, M  
BODY MARK GROUP  
BODY MARK  
BODY MARK DISPLAY

Text at the first line in the image area is retained.

<Imaging>

- e. Apply sufficient amount of ultrasound gel to the patient's skin in the scanning area and to the surface of the probe.

NOTE: The gel conducts the ultrasound from and to the probe. Without gel, air gets between probe and the skin and reflects the ultrasound, causing poor image.

- f. Touch the probe against the skin of the patient in the area to be scanned.

For details of imaging, measurement and other operation, see each section.

B-mode imaging

→ Section 7

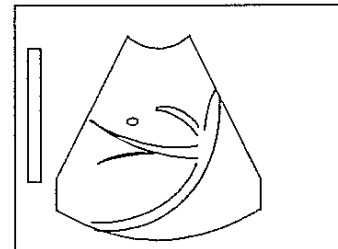

M-mode imaging

→ Section 8

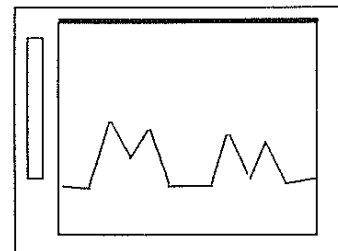

Measurement Distance Area/circumference → Section 9  
Velocity Heart rate  
Angle

Gestational age calculation → Section 10

Fetal weight calculation → Section 11

Character display → Section 12

Recording image by optional equipment → Section 13



---

---

## Section 7

# B-MODE IMAGING

---

---



## 7. B-MODE IMAGING

### 7.1 Introduction

B-mode is a mode in which a tomographic image of a scanning plane is displayed in two dimensional form.

B-mode image format:

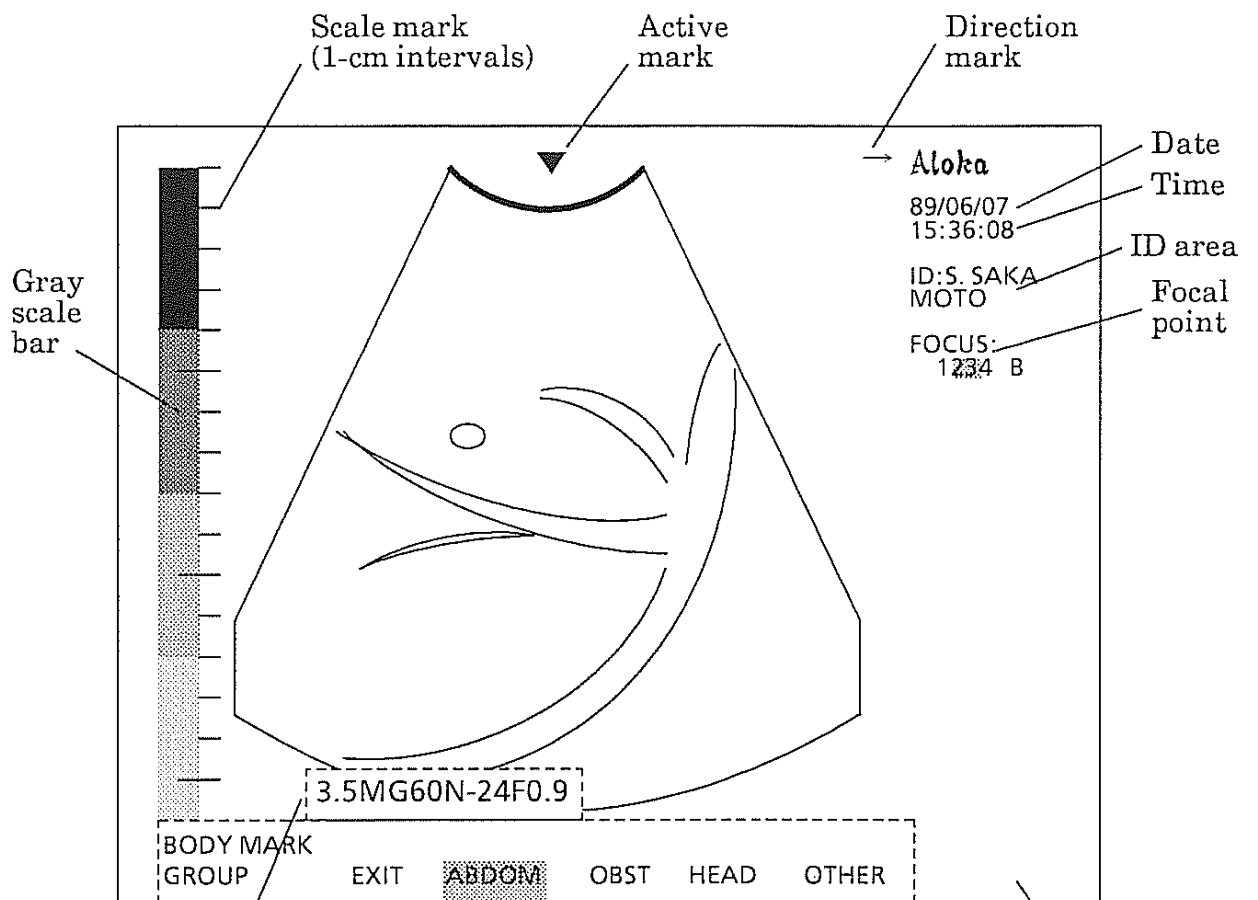

Equipment parameter data:

(Example)

3.5M: Probe frequency  
G60: Gain setting value  
N-24: Near gain setting value  
F0.9: Far gain setting value

Error message

\* See section 14  
TROUBLESHOOTING  
for the explanation.

7. B-MODE IMAGING  
7.1 Introduction

<Controls for image adjustment and useful functions>

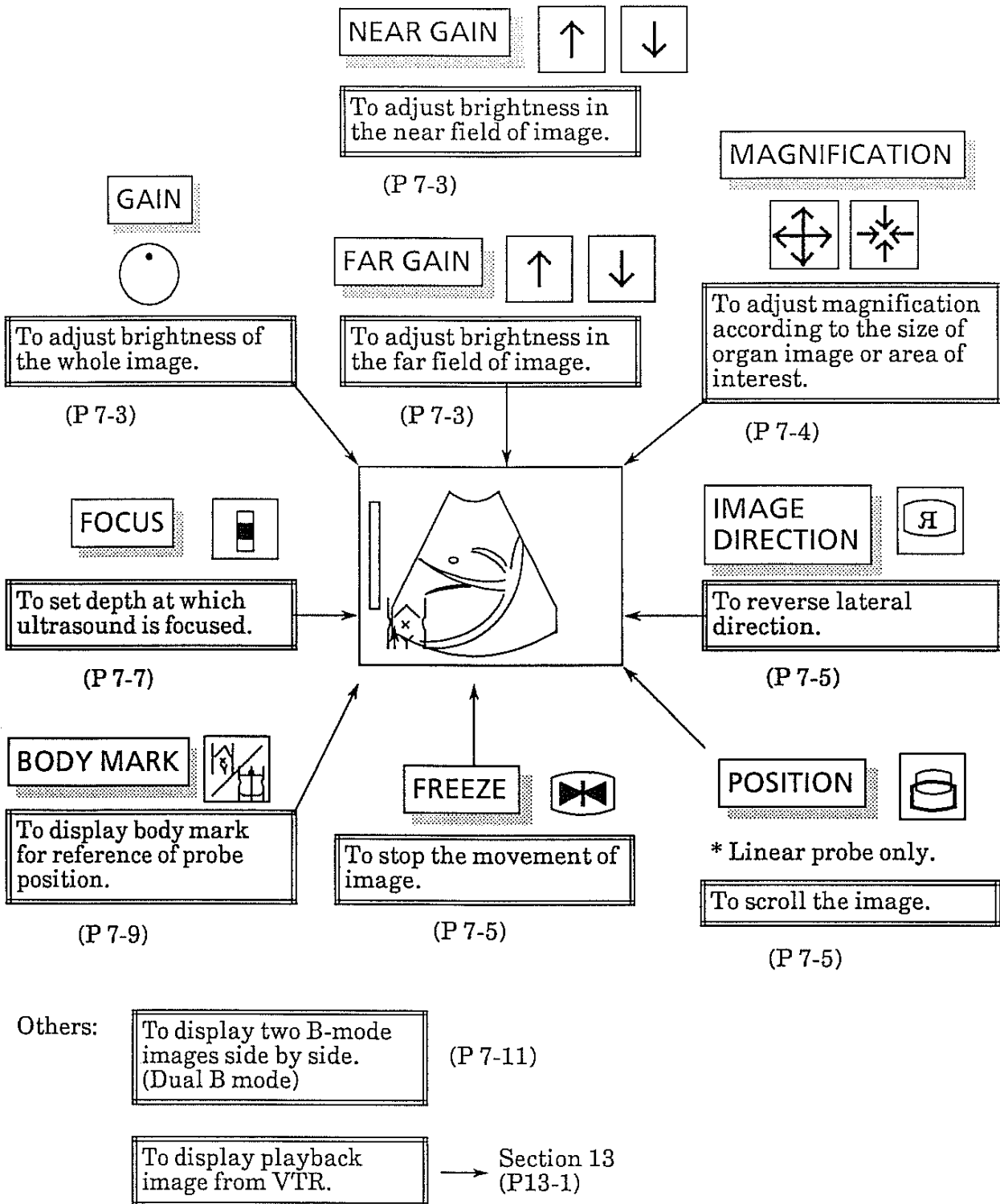



## 7.2 Adjustment of Image

### 7.2.1 To adjust overall brightness of B-mode image. (GAIN)

<Control>

GAIN

<Function>

Adjusts overall brightness of B-mode image

To increase the brightness, turn the GAIN knob clockwise.

To decrease the brightness, turn the GAIN knob counterclockwise.

<How to use>

As shown in Fig. 1, when the gain is insufficient, necessary echoes cannot be seen. As shown in Fig. 3, when the gain is excessive, echo is masked by noise.

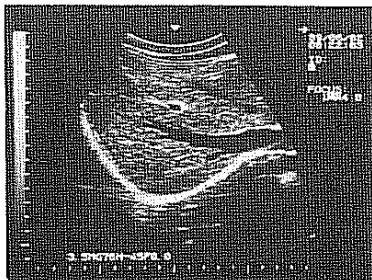

Fig. 1 Insufficient gain

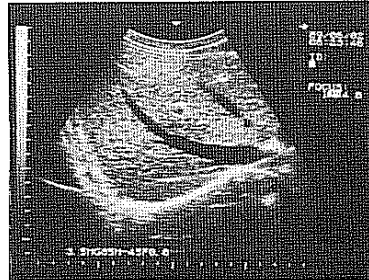

Fig. 2 Adequate gain

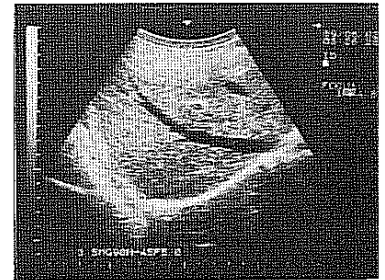

Fig.3 Excessive gain

### 7.2.2 To adjust brightness of a specific depth. (STC)

<Control>

STC (NEAR and FAR)

<Function>

STC (Sensitivity Time Control) is for adjusting the brightness of a specific depth.

<How to use>

Generally, at near field the echo is too strong and noise is strongly displayed, so reduce the sensitivity.

At far field, the echo is faint, so increase the sensitivity.

(See the figures below.)

7. B-MODE IMAGING  
7.2 Adjustment of Image

---

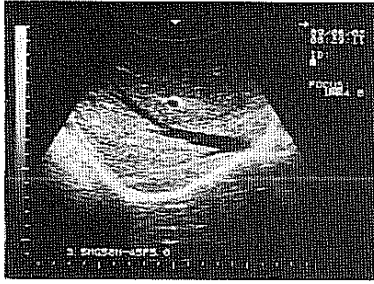

Fig. 1 STC non-adjusted

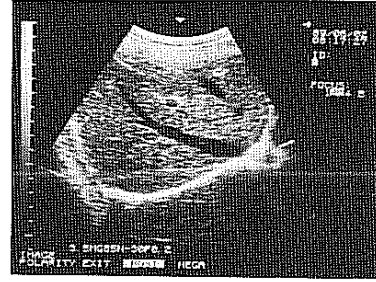

Fig. 2 STC adjusted

## 7.3 Useful Functions for B-mode Imaging

### 7.3.1 To magnify or reduce the image. (MAGNIFICATION)

<Control>

MAGNIFICATION

<Function>

Magnify or reduce the image.

<How to use>

To magnify the image, press the  switch.

To reduce the image, press the  switch.

When the standard probe is used, magnification can be changed in three steps as follows:

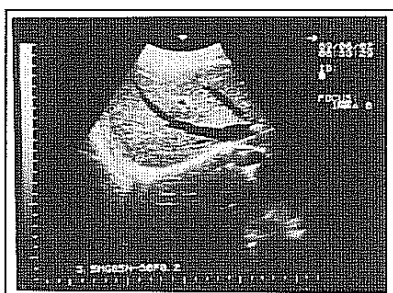

Fig. 1 Magnification:  $\times 0.75$   
Display range: 22 cm

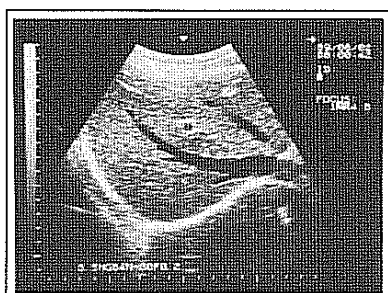

Fig. 2 Magnification:  $\times 1.0$   
Display range: 16 cm

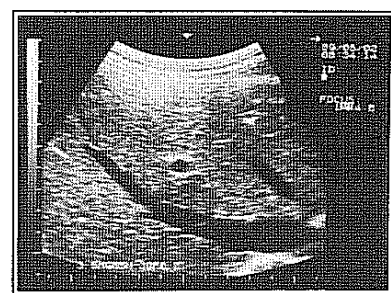

Fig. 3 Magnification:  $\times 1.5$   
Display range: 11 cm

<Note> Magnification of B/M mode image cannot be changed.

### 7.3.2 To invert lateral image orientation. (DIRECTION)

<Switch> IMAGE DIRECTION

<Function>

Inverts lateral orientation of image without changing probe position.

<How to use>

Press the **IMAGE DIRECTION** switch. When the lateral direction is inverted, the ← mark is displayed at the upper left of the image.

To return the lateral direction to normal, press the **IMAGE DIRECTION** switch again.

## 7. B-MODE IMAGING

### 7.3 Useful Functions for B-mode Imaging

---

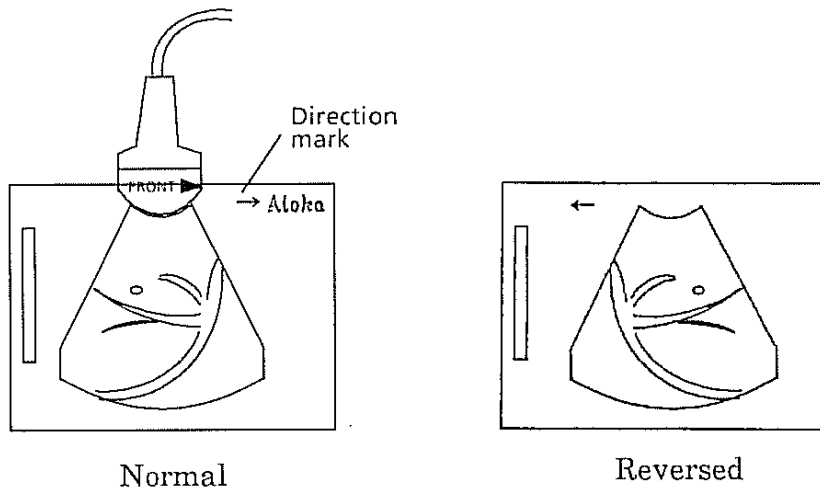

#### 7.3.3 To freeze the image. (FREEZE)

<Switch>

**FREEZE** or optional footswitch (MP-2345)

<Function>

To still (freeze) the B-mode image.

<How to use>

When you want to stop the image, press the **FREEZE** switch or the footswitch. The image freezes immediately.

<Information>

When the image is frozen, the time display also stops.

#### 7.3.4 To scroll the image vertically. (POSITION)

<Switch>

**POSITION** (panel B)

<Function>

To shift image display range up or down.

<Required Condition>

**MODE:** B, B|B, and M

**FREEZE:** Off;

**Magnification:** × 1.0 or × 1.5 (impossible at × 0.75)

<How to use>

- a. Press the POSITION switch. The switch lights.
- b. Use the Joypad or (Trackball) as follows:
  - ↑: The image is scrolled up.
  - ↓: The image is scrolled down.

When an image is scrolled, the distance of scrolling is displayed at the upper right corner of the image.

(Image scrolled distance is not displayed when the image is not scrolled up.)

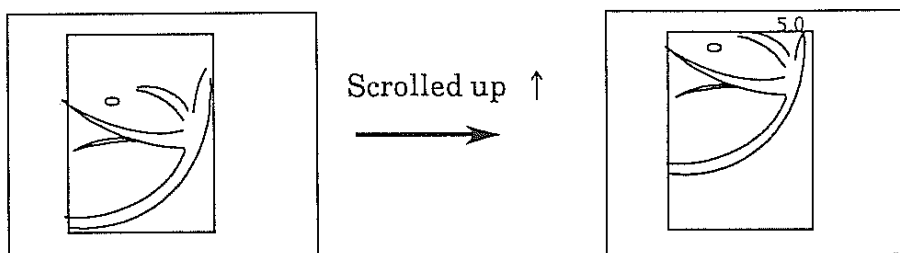

## 7. B-MODE IMAGING

### 7.3 Useful Functions for B-mode Imaging

#### 7.3.5 To Change Focal Point

CONTROL:

FOCUS

FUNCTION:

It is possible to select the focal point in transmission.

When multiple focal points are set, the system transmits ultrasound beams with varying focal point depth. (See the figure below.)

MENU:

B and B|B mode

FOCUS				
B	F1	F2	F3	F4

B/M and M modes

FOCUS				
B/M,M	F1	F2	F3	F4

F1, F2, F3 and F4: Each sets a focal point.

In B and B|B modes, combination of consecutive focal points is possible, however, selection is impossible at intervals. (For example, F1 and F3 cannot be selected at the same time.)

In B/M and M modes, only one of the focal points can be selected.

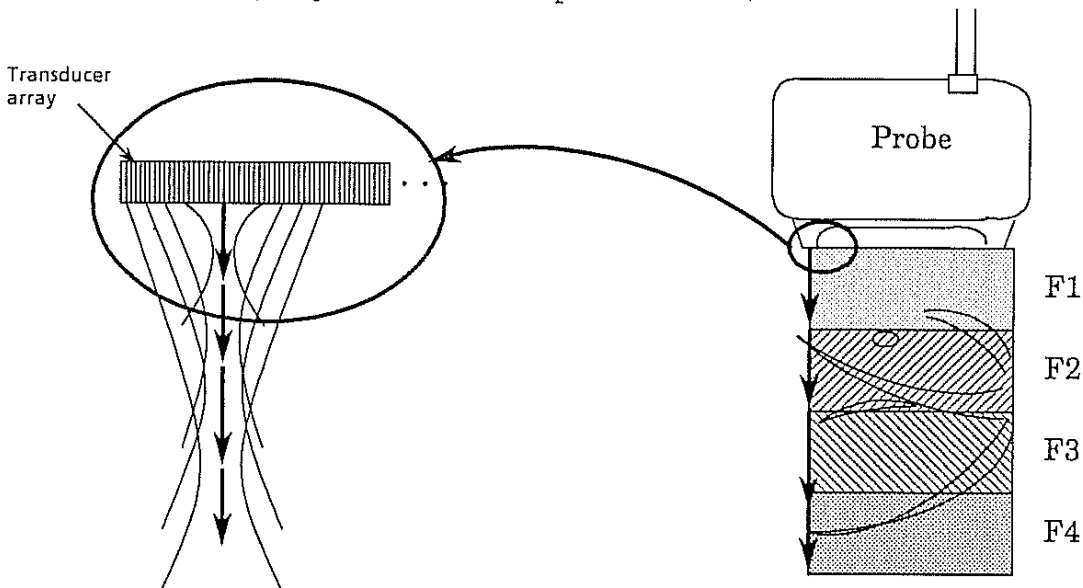

**INFORMATION:**

The number of focal points is in inverse proportion to the frame rate.  
The more focal points, the slower the frame rate.  
Combination of F2 and F3 focal points provides optimum imaging in general cases.  
(When the power is applied, F2 and F3 are automatically set.)

**NOTE:**

When selecting multiple focal points, no break can be made between the selected focal points. For example, F1 and F3 cannot be selected at the same time. F1, F2 and F3 can be selected at the same time.

When no focal points are set with the above menu, the system automatically sets 1-point broad focusing. (See the figure below.)

In B/M and M modes, it is possible to set one focal point at the same time.

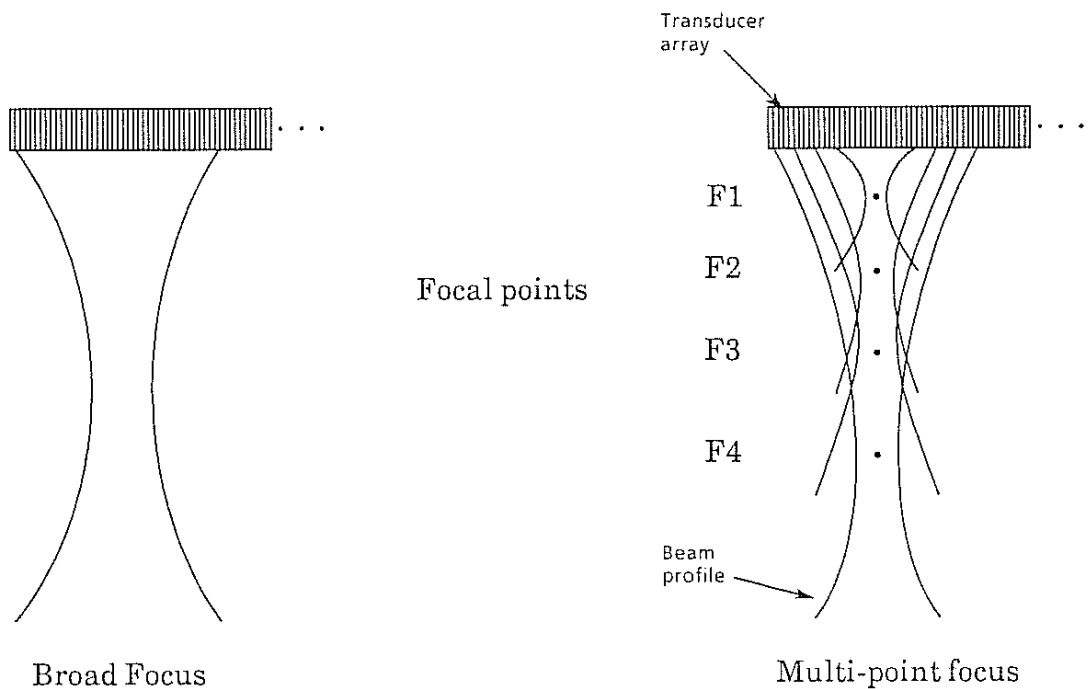

7. B-MODE IMAGING  
7.4 Displaying Body Mark

7.4. Displaying Body Mark

Selecting body mark group

- a. Press the  switch. BODY MARK GROUP menu is displayed as follows:

BODY MARK GROUP    **ABDOM**    OBST    HEAD    OTHER

- c. Select the body mark group you want to display. (See below.)

ABDOM group

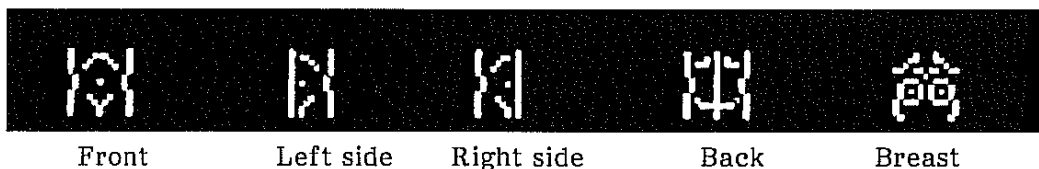

OBST group



HEAD group

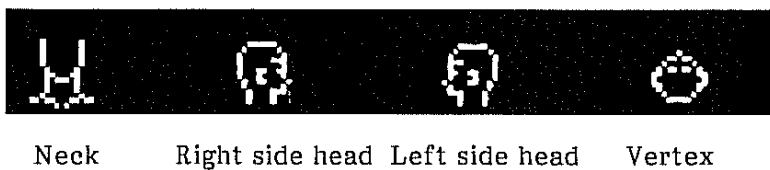

OTHER group

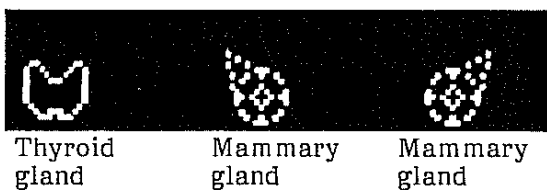



- c. Press the  switch.  
BODY MARK menu is displayed. (Example when ABDOM has been selected.)

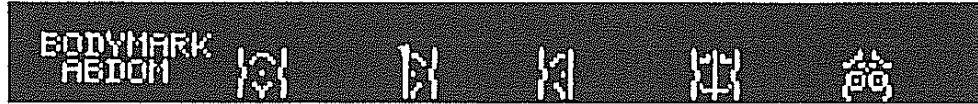

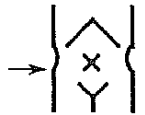

- d. Select the body mark you desire in the menu.  
The body mark with probe mark (→) is displayed.



### To position the probe mark

- Use the joystick (or trackball) to move the probe mark to the location that corresponds to the position in which the probe is actually applied.
- Rotate the probe mark using the PROBE MARK switch as follows:

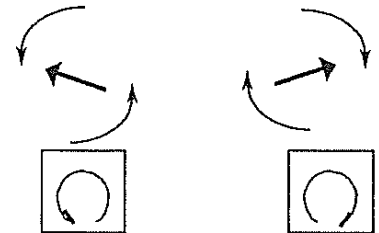

To rotate the probe mark clockwise, press the  switch.

To rotate the probe mark counterclockwise, press the  switch.



### To change the body mark

- When the body mark you desire is in the menu displayed on the screen:  
Select the body mark you desire in the menu.
- When the body mark you desire is not in the menu displayed at present:

- Press the  switch.
- Select the group you desire.
- Press the  switch.
- Select the body mark you desire.

### To erase the body mark

Reselect the highlighted body mark in the menu.

7. B-MODE IMAGING  
 7.5 Dual B mode Display

7.5 Dual B-Mode Display

<Control>



<Step>

It is possible to display two B-mode images at the same time, one is frozen and the other is either frozen or real-time.

- a. Display a B-mode image.
- b. Press the B|B switch. Dual B mode is achieved. The left frame displays real-time image.
- c. Press the B|B switch again. The left frame is frozen and the right frame displays real-time image.
- d. When the B|B switch is pressed once again, the right frame is frozen and the left frame displays real-time image.
- e. Pressing the B|B switch exchanges the frozen frame and the real-time frame. The real-time frame has an active mark (▼) above it.
- f. Pressing the B switch restores the display to single B mode.

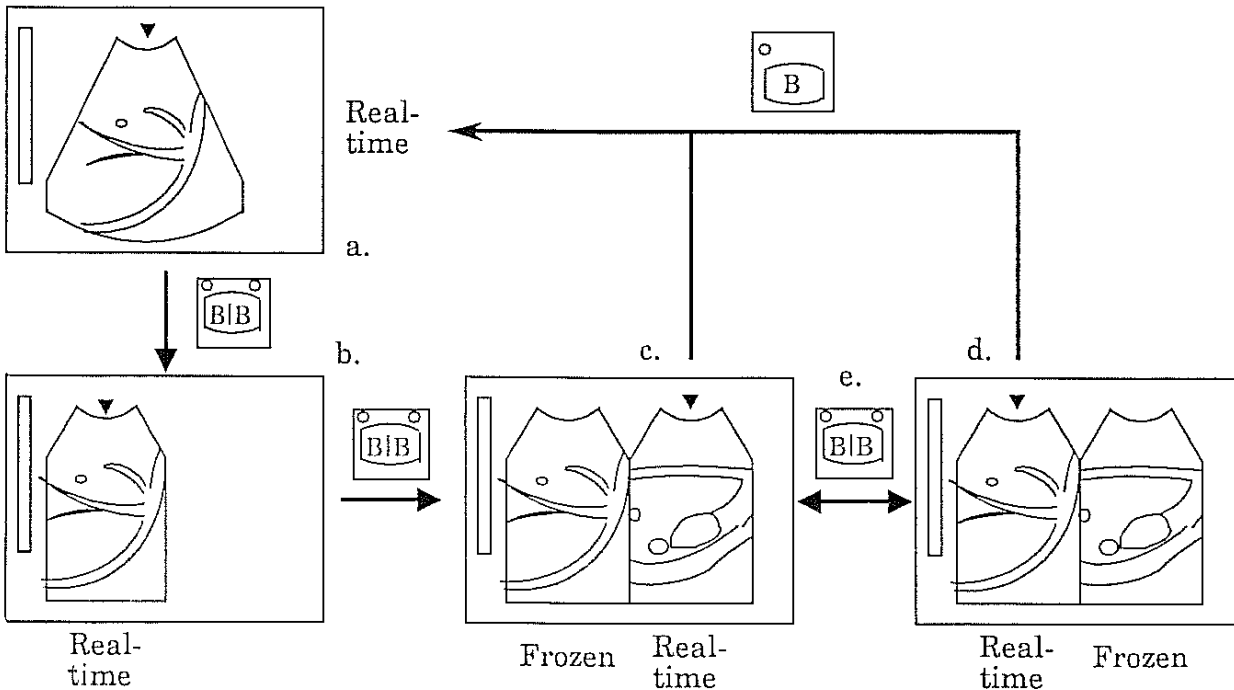

## Section 8

# M-MODE IMAGING



## 8. M-MODE IMAGING

### 8.1 Introduction

#### 8.1.1 Information

M-mode is a mode in which variation of echo depth over time is displayed while the probe is fixed in position,

As echo information for M-mode is sampled along a specified line, vertical movement of a heart valve can be imaged on the screen.

To show the sampling line, a line called the cursor is displayed on a B-mode image. Therefore, B/M mode which displays both B-mode and M-mode images at the same time is helpful for observing both the sampling line and a live M-mode image.

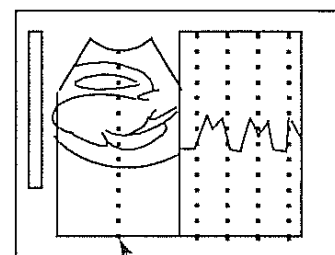

M-mode cursor

Usually the cursor is fixed at the center of the B-mode image, but it can be moved by menu operation.

Once the position of the cursor is determined, M-mode single display offers observation of the M-mode image for a longer time in a frame.

On the M-mode image, dotted lines are displayed at regular intervals.

Vertical interval between two dots is 1 cm.

Horizontal interval of dotted lines is 0.5 second.

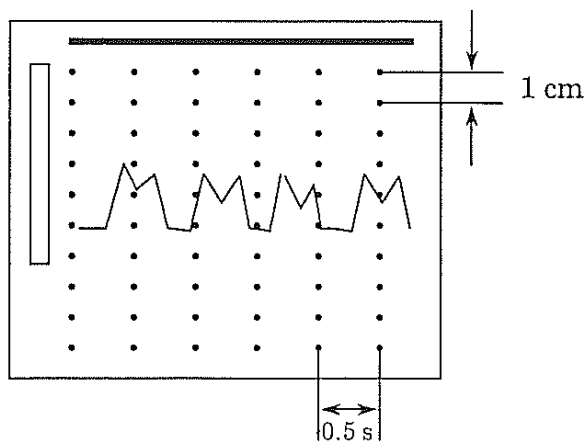

## 8. M-MODE IMAGING



### 8.1 Introduction



---

#### 8.1.2 Procedure of M-mode Imaging

Basic Step
------------

- a. Select B/M mode.
- b. Display a B-mode appropriate for M-mode display.  
The M-mode cursor is displayed at the center of the B-mode image.
- c. When it is desired to move the cursor position, use the joystick (or trackball).

NOTE: The M cursor can be moved by the joystick or optional trackball when  or  switch is pressed.

When the joystick (or trackball) is used for another function (such as distance measurement), press the  or  switch again. Then the joystick (or trackball) can be used for M cursor movement again.

- d. To display full screen M-mode image, press the M switch.

## 8.2 Adjustment of Image

### 8.2.1 To adjust overall brightness of M-mode image. (GAIN)

<Control>

GAIN

<Function>

Adjusts overall brightness of M-mode image

To increase the brightness, turn the GAIN knob clockwise.

To decrease the brightness, turn the GAIN knob counterclockwise.

<How to use>

As shown in Fig. 1, when the gain is insufficient, necessary echoes cannot be seen. As shown in Fig. 3, when the gain is excessive, the echo is masked by noise.

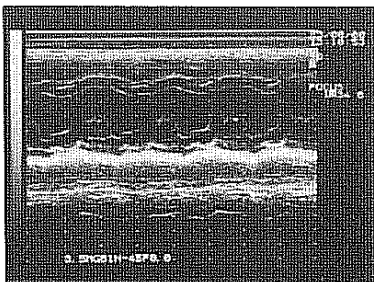

Fig. 1 Insufficient gain

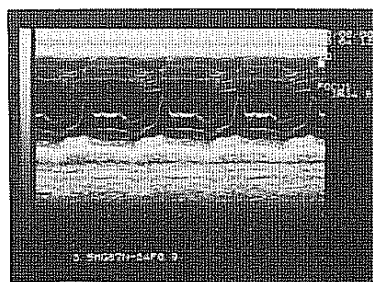

Fig. 2 Adequate gain

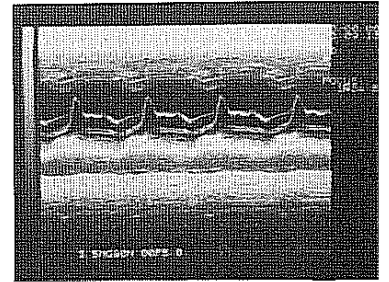

Fig. 3 Excessive gain

### 8.2.2 To adjust brightness of a specific depth. (STC)

<Control>

STC (NEAR and FAR)

<Function>

STC (Sensitivity Time Control) is for adjusting brightness of a specific depth.

<How to use>

Generally, at near field the echo is too strong and noise is strongly displayed, so reduce the sensitivity.

At far field, the echo is faint, so increase the sensitivity.

(See the figures below.)

8. M-MODE IMAGING  
8.2 Adjustment of Image

---

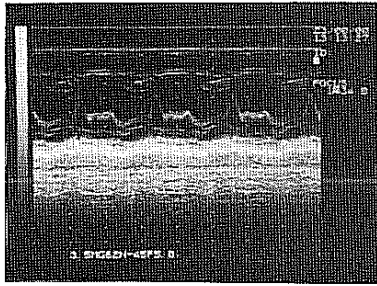

Fig. 1 STC non-adjusted

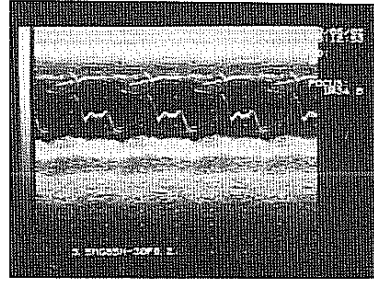

Fig. 2 STC adjusted



### 8.3 Useful Functions for M-mode Imaging

#### 8.2.3 To magnify or reduce the image. (MAGNIFICATION)

<Control>

MAGNIFICATION

<Function>

Magnify or reduce the image.

<How to use>

To magnify the image, press the  switch.

To reduce the image, press the  switch.

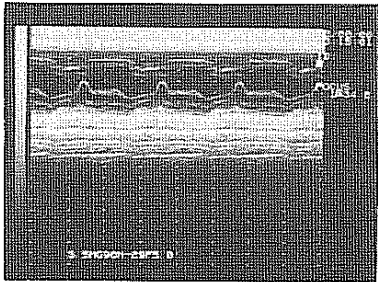

Fig. 1 Magnification: x0.75  
Display range: 22 cm

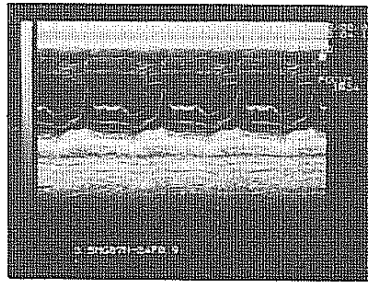

Fig. 2 Magnification: x1.0  
Display range: 16 cm

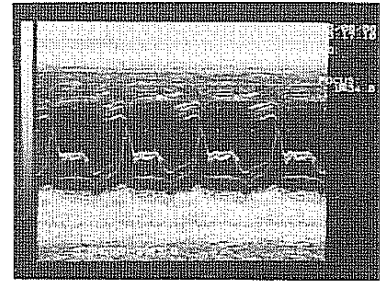

Fig. 3 Magnification: x1.5  
Display range: 11 cm

<Notes>

The magnification can be varied in three steps: x0.75, x1.0, and x1.5.  
Magnification of B/M mode image cannot be changed.

## 8. M-MODE IMAGING

### 8.3 Useful Functions for M-mode Imaging

---

#### 8.2.4 To make the image still. (FREEZE)

##### <Switch>

FREEZE switch or optional footswitch (MP-2345)

##### <Function>

To still (freeze) the B-mode image.

##### <How to use>

When you want to stop the image, press the FREEZE switch or the footswitch. Image freezes when the renewal of image reaches the right end.

##### <Information>

When the image is frozen, the time display also stops.

## Section 9

# BASIC MEASUREMENTS



## 9. BASIC MEASUREMENTS

### 9.1 Distance

<Function>

Measures a distance between two arbitrary points a on B-mode image.  
Two different distances can be measured at the same time.

<Step>

- a. Display a B-mode image.  
When a desired image is displayed, freeze the image with the **FREEZE** switch.

- b. Press the  switch.

**NOTE:** Distance measurements may also be engaged merely by displaying a B-mode image and pressing either the **+** or **×** switch.

- c. Caliper mark (+ or ×) is displayed at the center of the image.

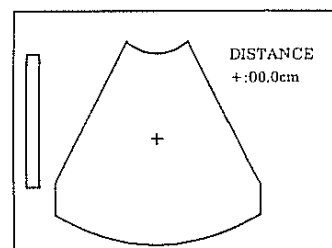

Fig. 9-1

- d. Operate the **joypad** (or optional trackball) to position the mark to a starting point for distance measurement.

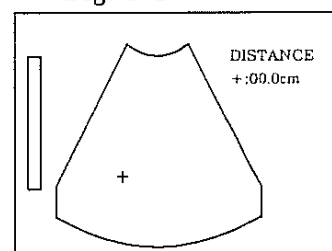

Fig. 9-2

- e. Press the **MARK REF** switch.



Operate the **joypad** (or trackball) to move the mark to an end point.

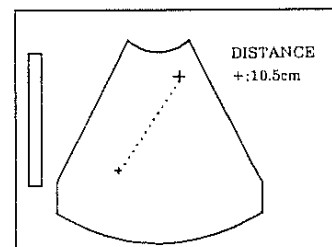

Fig. 9-3

**NOTE:** The pressing of the **MARK REF** switch and operating of the **joypad** (or trackball) will split the mark in two, one large and the other small.

## 9. BASIC MEASUREMENTS

### 9.1 Distance

The distance between the two marks will be displayed in the measurement data display area as shown to the right.

DISTANCE  
+: 10.5 cm

NOTE: Always the large mark may be moved with the joypad (or trackball). The positions of the large and small marks are interchanged by pressing the MARK REF switch.

- f. The × caliper mark can be displayed by pressing the × switch. The × caliper mark serves the same purpose as the + mark, and can be manipulated in the same manner.

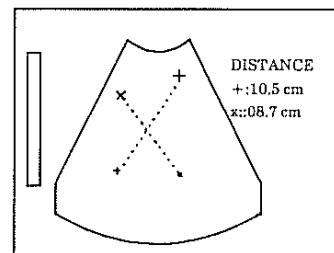



Fig. 9-4

- g. To terminate the measurement, press the  switch. All the measurement marks and results will be erased.

NOTE: If you want to erase only one set of calipers and measurement results, turn on the + or × switch corresponding to the mark then press it again to erase.

NOTE: Distance measurement over the boundary of two images is possible only when probe and magnification are the same.

In other cases, the caliper markers move only in the image indicated by the active mark ▼.

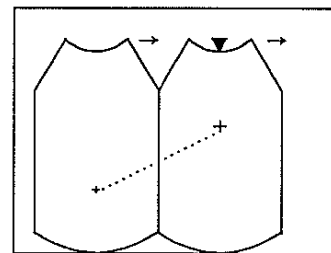

Fig. 9-5

**9.2 Area/Circumference**

<Function>

Measures the area and circumference of the area enclosed in an elliptical mark.  
 Two different areas and circumferences can be measured at the same time.

<Step>

- a. Display a B-mode image. (B|B or B/M mode is also possible.)  
 When a desired image is displayed, freeze the image with the **FREEZE** switch.

- b. Press the  switch.

The area measurement mark "+" will appear at the center of the screen. And the + CALIPER MARK switch lights.

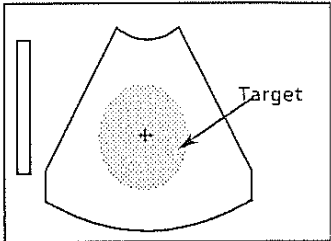

Fig. 9-6

- c. Use the **joypad** (or **trackball**) to position the mark to one end of the long axis of the target.

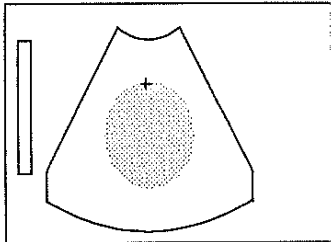

Fig. 9-7

- d. Press the **MARK REF** switch.  
 Use the **joypad** (or **trackball**) to position the + mark to the other end of the long axis.

**NOTE:** The original + mark remains on the spot and the other + mark can be moved.

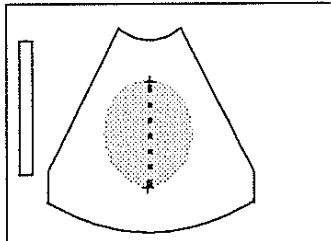

Fig. 9-8

- e. Press the **MARK REF** switch, and an ellipse mark appears.

It is possible to adjust the short axis length of the ellipse mark by the joypad or trackball.

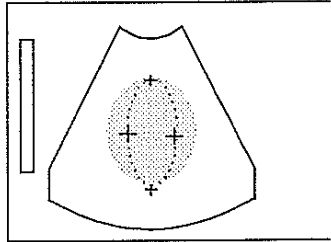

Fig. 9-9

## 9. BASIC MEASUREMENTS

### 9.2 Area/Circumference

Use the joystick (or trackball) to adjust the short axis length of the mark.

Pressing the right .... lengthens the short axis length

Pressing the left ..... shortens the short axis length

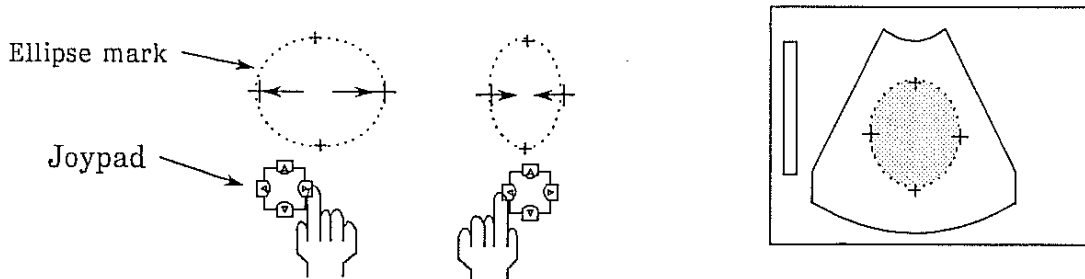

Fig. 9-10

If the position and shape of the mark are still not the same as those of the target, follow the procedure below.

- f. Press the **MARK REF** switch.

The apex opposite to the base point can be moved by the joystick (or trackball).

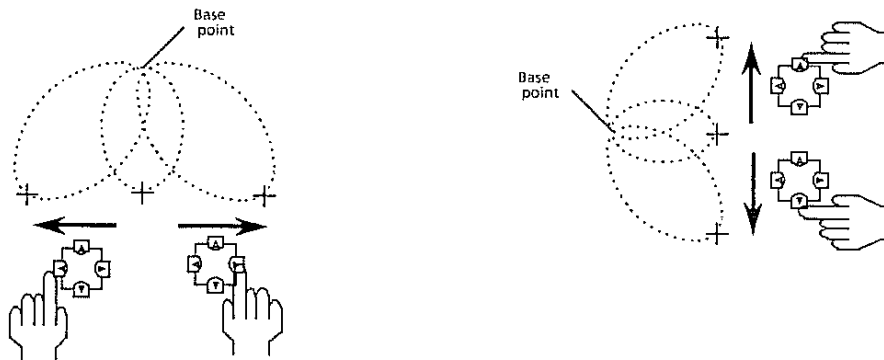

Fig. 9-11

- g. Press the **MARK REF** switch. The base point shifts to the other side. Readjust the position or vertical length.

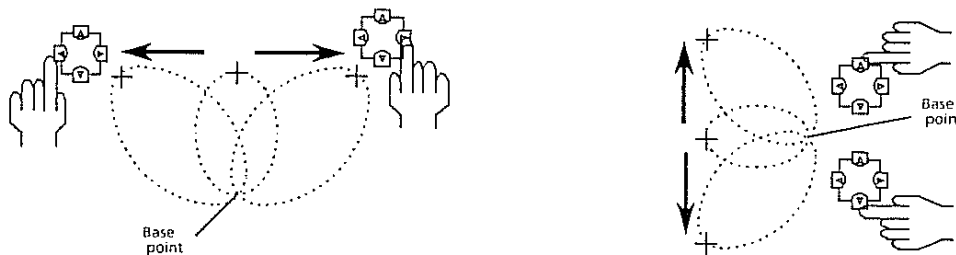

Fig. 9-12



The area, circumference (C), short axis (S), and long axis (L), of the ellipse are computed and displayed.

- h. By pressing the **MARK REF** switch again, the short axis length may be readjusted with the joypad. (Same as step "d.")

Steps "d." through "f." may be repeatedly carried out by pressing the **MARK REF** switch.

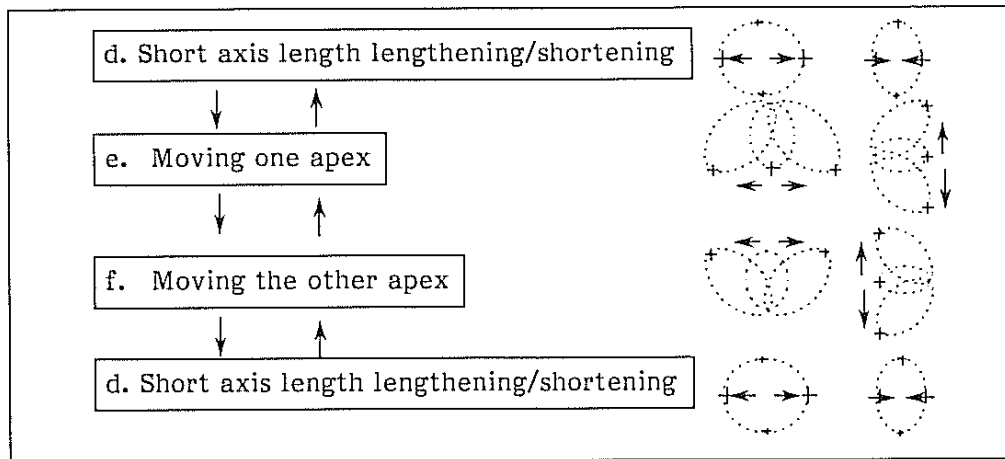

- i. By pressing the "x" switch, another area measurement is possible by the "x" mark.

- j. To terminate the measurement, press the  switch. All the measurement marks and results will be erased.

**NOTE:** If you want to erase only one set of calipers and measurement results, turn on the "+" or "x" switch corresponding to the mark then press it again to erase.

**Area Measurement Data Reading:**

**ELLIPSE**

**+:041.2 cm<sup>2</sup>** The area enclosed in a "+" mark ellipse in square centimeter.

**C:25.7 cm** The circumference of a "+" mark ellipse in centimeter.

**S:05.0 cm** The short axis length of a "+" mark ellipse in centimeter.

**L:10.4 cm** The long axis length of a "+" mark ellipse in centimeter.

(The measurement data of "x" mark is displayed under the measurement data of "+" mark.)

## 9. BASIC MEASUREMENTS

### 9.3 Velocity

#### 9.3 Velocity

<Function>

The velocity is calculated by the following equation;

$$\text{Velocity (cm/s)} = \text{Dimension (cm)} / \text{Time interval (sec)}$$

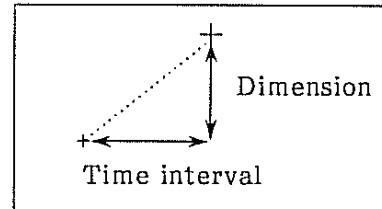

- Select **M** mode (B/M mode is also possible) with the **MODE** switch. When a desired image is displayed, freeze the image with the **FREEZE** switch.

Press the  switch.

**NOTE:** Velocity measurements may also be possible merely by having an M-mode image displayed and pressing either the "+" or "x" of the **CALIPER MARK** switch.

A "+" caliper mark will appear at the center of the screen and the "" **CALIPER MARK** switch lights.

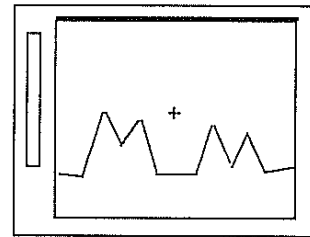

Fig. 9-13

- Operate the **joypad** (or **trackball**) to position the mark to a starting point for velocity measurement.

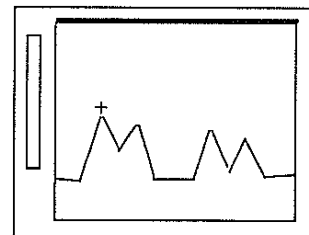

Fig. 9-14

- Press the **MARK REF** switch. Operate the **joypad** (or **trackball**) to move the mark to an end point.

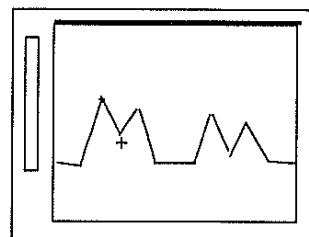

Fig. 9-15

NOTE: The pressing of the MARK REF switch and operating of the joypad splits the mark in two, one large and the other small.

The velocity, dimension and time interval between the two marks are displayed in the measurement data display area.

NOTE: One of the two split marks may be moved with the joypad at a time. You can switch two marks by pressing the MARK REF switch.

d. Another velocity may be measured by the "x" mark. Press the " x " switch and operate the mark in the same manner as the "+" mark.

All the measurement marks and results will be erased.

NOTE: If you want to erase only one set of calipers and measurement results, turn on the appropriate "+" or "x" switch corresponding to the mark, then press it again to erase.

e. To terminate the velocity measurement, press the  switch.

VEL Measurement Data Reading:

VELOCITY

+:02.0 cm/s	Velocity between the "+" marks in cm/s.
D:01.1 cm	Distance between the "+" marks in cm.
T:0.53s	Time interval between the "+" marks in seconds.
X:12.5 cm/s	Velocity between the "x" marks in cm/s.
D:02.0 cm	Distance between the "x" marks in cm.
T:0.16s	Time interval between "x" marks in seconds.

## 9. BASIC MEASUREMENTS

### 9.4 Heart Rate

#### 9.4 Heart Rate

<Function>

By measuring the time interval of two cardiac cycles (heartbeats), the heart rate is automatically computed. The computation is based on the time measurement result.

The heart rate is calculated by the following equation:

$$\text{Heart Rate (beats/min)} = 120/T \text{ (sec)}$$

(T: Time duration of two heartbeats)

<Step>

- a. Select **M** mode (B/M mode is also possible) and display an appropriate image. Freeze the image.  
Press the **MENU** switch. A measurement menu is displayed.  
Select "**NEXT**" twice. The page 3 of the menu is displayed:



Select "**H-RATE**" in the menu.

A "+" caliper mark is displayed on the screen, and the " + " caliper mark switch lights.

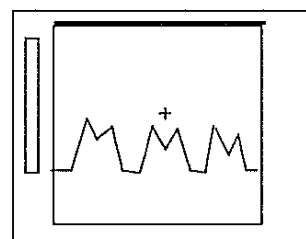

Fig. 9-16

- b. Operate the joypad (or trackball) to position the mark to a starting point for the intended heart rate measurement.

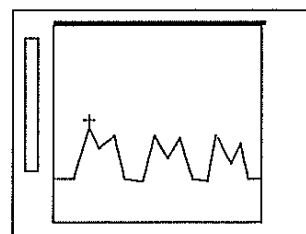

Fig. 9-17

- c. Press the **MARK REF** switch.  
Operate the joystick (or trackball) to move the mark over an M-mode image portion covering **two heartbeats** (in mutually corresponding phases).

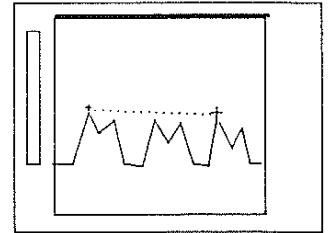

Fig. 9-18

The measured timed interval and the calculated heart rate are displayed.

Each time the **MARK REF** switch is pressed, the movable mark under joystick control is switched from one of the marks to the other.

- d. Another heart rate may be measured with the "x" mark.  
Press the "x" switch and operate the "x" mark in the same manner as the "+" mark.
- e. To terminate the measurement, select "**H-RATE**".  
All the measurement marks and results are erased.

H-RATE Measurement Data Reading:

(Example)

HEART RATE

+ :067 b/m

T:1.78s

Heartbeats per minute.

Time interval between the  
" + " marks.

**9.5 Angle**

<Function>

It is possible to measure two angles from the base line to obtain the bony roof angle and the cartilaginous roof angle of the hip joint.

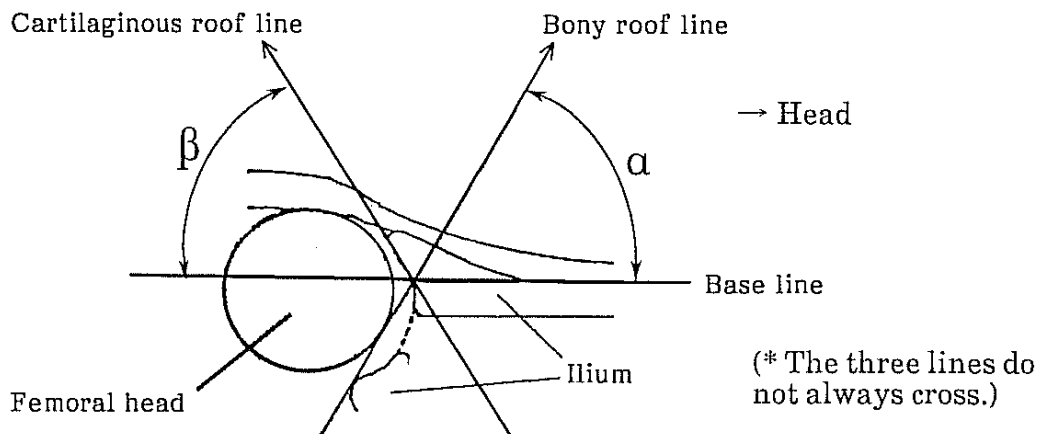

<Note>

Put the baby on its side. Place the probe so that the head side comes on the right of the image. Always display the bony roof angle to the right and cartilaginous angle to the left.

Angles greater than 90° are not measured. (The indication becomes "\*\*\*" instead.)

<Step>

- a. Display a B-mode image of the hip joint at the position shown in the above figure. When the desired image is displayed, freeze the image with the **FREEZE** switch.
- b. Press the **MENU** switch. MENU-1 menu is displayed.

MENU-1	FRM-CO	IMG-PO	PUNC	NEXT
--------	--------	--------	------	------

Select **NEXT** twice. MENU-3 menu is displayed.

MENU-3	ANGLE	NEXT
--------	-------	------

Select **ANGLE** in the menu. ANGLE menu is displayed.

ANGLE	EXIT	<b>B LIN</b>	α	β
-------	------	--------------	---	---

"B LIN" is automatically selected. (B LINE stands for base line.)

## 9. BASIC MEASUREMENTS

### 9.5 Angle

- c. Use the **joypad** (or **trackball**) to position the **+** mark at the starting point of the base line.

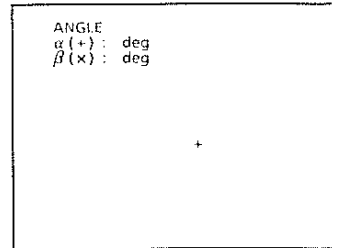

- d. Press the **MARK REF** switch, and a horizontal line, that starts from the **+** mark and ends at the right edge of the image, appears.

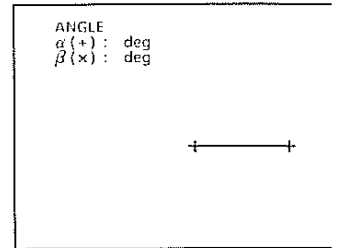

When you want to move the starting or ending point of the line, use the **joypad** (or **trackball**). The **MARK REF** switch changes the mark that can be moved between the two.

- e. Select  $\alpha$  in the menu.  
 A **+** mark is displayed.

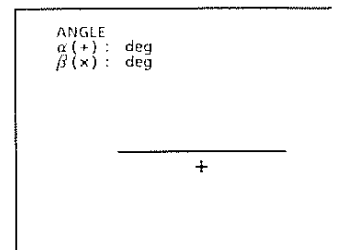

- f. Use the **joypad** (or **trackball**) to position the **+** mark to the bony acetabular rim.

Press the **MARK REF** switch.

A left-down oblique line of about  $45^\circ$  is displayed starting from the mark.

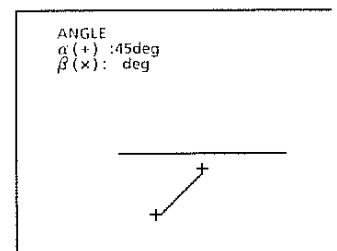

Using the **joypad** (or **trackball**), move the left end of the line to the lower iliac margin.

- g. Select  $\beta$  in the menu.  
 A left-up oblique line of about  $45^\circ$  is displayed starting from the mark.

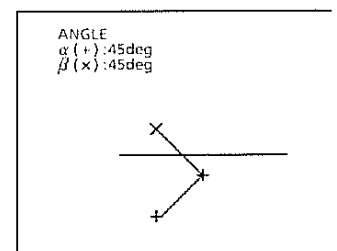

- h. Use the **joypad** (or **trackball**) to position the **x** mark to align the line and the acetabular labrum.

You can move the intersection point by pressing the **MARK REF** switch and using the **joypad** or **trackball**.

When you want to reposition the end of a line, press **MARK REF** switch. Select  $\alpha$  or  $\beta$  for the desired mark.

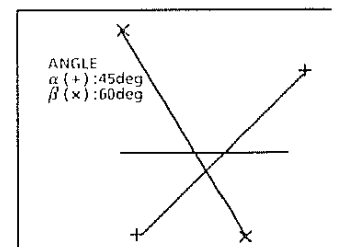

It is possible to extend the lines fully in the image area by selecting the item in the menu that is highlighted.

- i. To terminate the measurement, select **EXIT** or press the **MENU** switch.

**9.6 Ratio**

<Function>

Ratio of two measurement values can be calculated.

<Step>

- a. Measure the necessary parts.
- b. Press the **OB CAL** switch. **OB-MEASURE** menu is displayed.  
Select **NEXT** twice to display **PAGE-3** menu.  
Select **RATIO** in the menu.
- c. Input of numerator:

Measurement value at the top is highlighted.  
If the value is appropriate for the numerator, select **N** in the menu.  
The value is registered as the numerator.

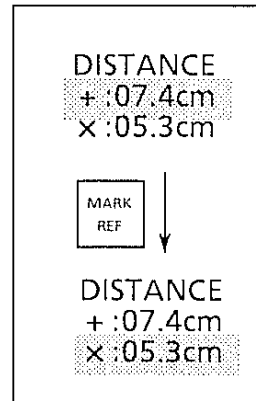

- d. Input of denominator:  
  
Measurement value at the top is highlighted.  
If the value is appropriate for the denominator, select **D** in the menu.  
The value is registered as the denominator.

If the highlighted value is not appropriate for the denominator, press the **MARK REF** switch until an appropriate value is highlighted. Then select **D** in the menu.

- e. Calculated result is displayed.
- f. To terminate measurement, select **EXIT** or press the **MENU** switch.

<b>RATIO</b>	
N/D :	140%
N	07.4
D	05.3

<Note>

When calculation is impossible because of an inappropriate value (e.g. "0.0" for the denominator), "\*\*\*\*%" is displayed.

if there is only one measurement value, the error message "Inv. Mode" is displayed.



---

**Section 10**

**GESTATIONAL AGE CALCULATION**

---



## 10 GESTATIONAL AGE CALCULATION

### 10.1 Introduction

This equipment can calculate an estimated gestational age and delivery date by either of the following two methods:

**Indicator method** (→Sec. 10.2, Page 10-2)

The calculation is done by entering a date which can be an indicator for early stages of pregnancy. Indicators include last menstrual period, basic body temperature and manually entered date.

→See 10.2 Indicator Method.

**Parameter method** (→Sec. 10.3, Page 10-6)

The calculation is done by measuring a parameter that is assumed to indicate growth of an fetus.

The calculation is automatically done based on one of the fetal growth tables incorporated in the unit.

→See 10.3 Gestational Age Calculation by Parameter Method.

#### <Calculation Version>

This unit contains the following five versions for the calculation "b" above and one of them has been set at the factory:

USA version

Europe I version (Hansmann)

Europe II version (Campbell)

Tokyo university version

(The above four provide deviation with date.)

Osaka university version

(The above provides deviation with ratio to the standard deviation.)

Only one of the above versions can be used at one time. The version can be selected by internal switch. However, to change the version, it is necessary to open the unit cover. Since opening cover by the user is prohibited, contact our distributor if you want to change the version.

10. GESTATIONAL AGE CALCULATION  
10.2 Indicator Method

10.2 Indicator Method

Note: When Osaka university method is used, it is necessary to enter basic indexes by the following procedure. For other methods (USA, Europe and Tokyo university ) this entry is not necessary.

<Contents of Indicators>

One of the following three indicators can be selected by the menu for the calculation:

LMP (Last Menstrual Period):

The first day of the last menstrual period is to be entered.

BBT (Basal Body Temperature):

The estimated date of ovulation is to be entered.

MANU (Manual):

Calculation is possible when there is a known gestational age at a known examination date.

<Step>

This calculation is possible in B and B/M modes.

a. Press the **OB-CAL** switch.

<Osaka university method>

The following menu is displayed.

OB-MEASUR				
PAGE-1	CLEAR	CGW/EDC		NEXT

<USA and Europe methods>

OB-MEASUR					
PAGE-1	CLEAR	BPD	CRL	FL	NEXT

Select NEXT twice. The following menu is displayed.

OB-MEASUR				
PAGE-3	CLEAR	CGW/EDC		NEXT

- b. Select "CGW/EDC" in the menu. The menu changes as follows:

CGW/EDC	EXIT	LMP	BBT	MANU	OFF
---------	------	-----	-----	------	-----

- c. Select the desired indicator in the menu.  
The menu changes as follows:  
(LMP is used as an example.)

LMP					
CGW/EDC	EXIT	RETURN			SET

- 1 EXIT: Jumps to the OB MEASUR PAGE-1 menu containing table of gestational week calculation.  
2 RETURN: Returns to the previous menu (in step "b." above).  
5 SET: After the date entry, select this to register the date.

- d. Using the keyboard, enter the date from the keyboard. The date to be entered differs according to the method employed. See ① to ③ below.

GEST. CALC. LMP= /
-----------------------

NOTE: Follow the date display format you have selected. (See PAGE 5-5.)

If the number of month or day is less than 10, enter 0 for the tens digit.

① Last menstrual period (LMP)

Enter the first day of last menstrual period from the keyboard.  
Then select "SET" in the menu.

GEST. CALC	
LMP = 02/15	← The first day of last menstrual period
CGW : 15w 1d	← Calculated Gestational Weeks
EDC : 89/11/22	← Expected Date of Confinement

② Ovulation day (BBT)

Enter the estimated ovulation date based on the basal body temperature.  
Then select "SET" in the menu.

GEST. CALC	
BBT = 02/27	← Estimated ovulation date
CGW : 15w 3d	← Calculated Gestational Weeks
EDC : 89/11/20	← Expected Date of Confinement

## 10. GESTATIONAL AGE CALCULATION

### 10.2 Indicator Method

---

#### ③ Manual input (MANU)

Enter known examination day.

The date is displayed at the item of "KED".

GEST. CALC	
KED = 04/15	← Known examination day
KGW : w d	← Known gestational week

Select "SET" for registration.

Enter known gestational weeks from the keyboard. It is displayed at the item of "KGW".

GEST. CALC	
KED = 04/15	← Known examination day
KGW : 08w 3d	← Known gestational week

Select "SET" for registration.

Today's date, estimated gestational weeks, and expected date of confinement are automatically calculated and displayed.

GEST. CALC	
DATE = 06/01	← Today's date
CGW : 15w 1d	← Calculated Gestational Weeks
EDC : 89/11/22	← Expected Date of Confinement

f. To operate another menu function, select **EXIT**.

OB-MEASUR PAGE-1 menu is displayed.

g. To erase the data display, select **RETURN**, then select **OFF**.

**NOTE:** The displayed data is retained until the following operation is performed.

- ① "OFF" in the menu is selected.
- ② Power of the equipment is turned off.

CGW and EDC are calculated by the following expressions:

When **LMP** is selected:

$$\begin{aligned} \text{CGW} &= (\text{DATE} - \text{LMP}) \div 7 \\ \text{EDC} &= \text{LMP} + \text{PW} \times 7 \end{aligned}$$

**CGW:** Calculated Gestational Week  
**EDC:** Estimated Date of Confinement  
**LMP:** Date of first day of Last Menstrual Period  
**PW:** Pregnancy Week

When **BBT** is selected:

$$\begin{aligned} \text{CGW} &= [(\text{DATE} - \text{BBT}) \div 7] + 2 \\ \text{EDC} &= \text{BBT} + (\text{PW} - 2) \times 7 \end{aligned}$$

When **MANU** is selected.

$$\begin{aligned} \text{CGW} &= \text{B} + (\text{DATE} - \text{A}) \div 7 \\ \text{EDC} &= \text{DATE} + (\text{PW} - \text{CGW}) \times 7 \end{aligned}$$

**A** = Known examination day  
**B** = Gestational weeks at the known examination day

10. GESTATIONAL AGE CALCULATION  
10.3 Parameter Method

10.3 Gestational Age Calculation by Parameter Method.

<Information>

This equipment has five different versions, each with its own fetal growth tables. One of the versions has been set at the factory.  
For the tables, see page 10-12 onward.

Parameters which can be used for each version are as follows:

Version	Parameter (* See below)
USA	BPD, CRL, FL, AC, HC
Europe I	BPD, CRL, FL, HL
Europe II	BPD, FL, AC, HC
Tokyo university	BPD, CRL, GS, LV, F
Osaka university	BPD, CRL, FTA, FL, HL

NOTE: Even if the same parameters are used, the contents of the fetal growth tables differ from each other.

\* The abbreviations are spelt out below:

Parameter	Full spelling
AC	Abdominal Circumference
BPD	Biparietal Diameter
CRL	Crown-Rump Length
F (or FL)	Femur Length
FTA	Fetal Trunk Cross-Sectional Area
GS	Gestational Sac
HC	Head Circumference
HL	Humeral length
LV	Length of Vertebrae



<Reference>  
Part to be measured for the calculation.

BPD (Biparietal Diameter)

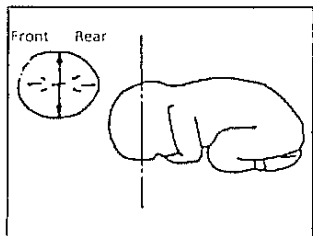

CRL (Crown-Rump Length)

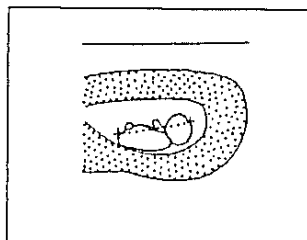

GS (Gestational Sac)

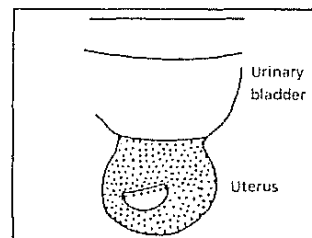

LV (Length of Vertebrae)

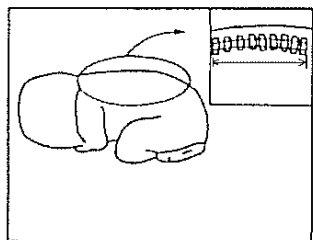

FL (Femur Length)

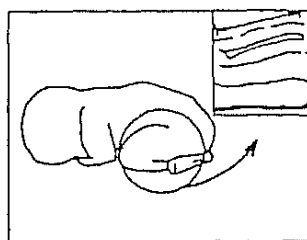

AC (Abdominal Circumference)

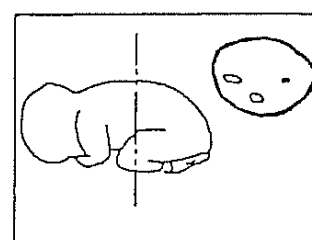

HC (Head Circumference)

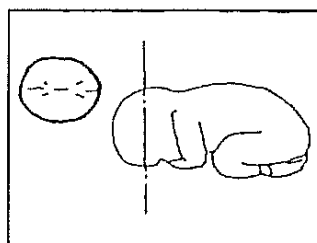

FTA (Fetal Trunk Cross Sectional Area)

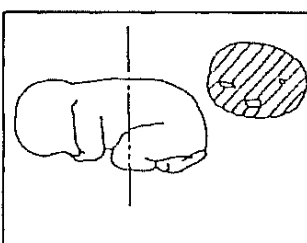

HL (Humerus Length)

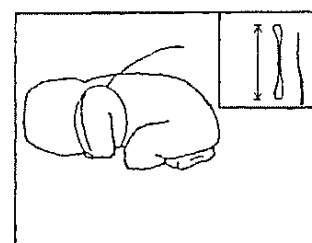

10. GESTATIONAL AGE CALCULATION  
 10.3 Parameter Method

Explanation of deviation

a. Days (Tokyo univ. and USA/Europe method)

Deviation is given as the number of days different from the standard curve.

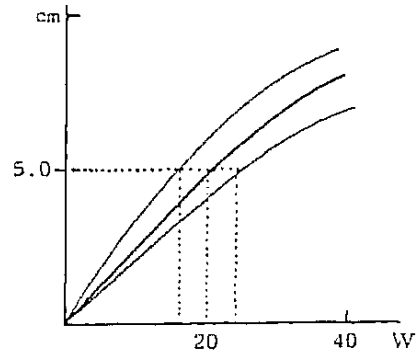

b. Standard deviation (Osaka univ. method)

The figure to the right is given as an example.

The difference is expressed as follows:

(Example)

$$\frac{5.1 \text{ (Measured value)} - 4.8 \text{ (Standard value)}}{0.29 \text{ (SD: standard deviation)}} = +1.03$$

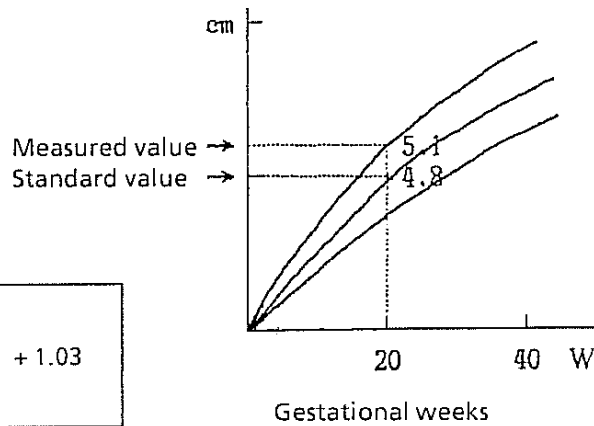

NOTE: The graph is not displayed on the screen.

Step for Calculating Gestational Age

<USA, Europe and Tokyo University version>

(1) When the parameter is selected before measurement

For example when USA version is incorporated and BPD is selected.

- a. Press the **OB CAL** switch.  
The following menu is displayed:

OB-MEASUR					
PAGE-1	CLEAR	BPD	CRL	FL	NEXT

If you want AC and HC, select **NEXT** to display the next page of the menu.

- b. Select **BPD** in the menu. A "+" caliper mark is displayed on the screen.  
And the menu changes as follows:

BPD			
-KURTZ	EXIT		SET

- c. Using the **joypad** (or trackball) and the **MARK REF** switch, measure the BPD in the same way as the distance measurement.
- d. Select **SET** in the menu.  
The measured value and calculated results appear as follows:

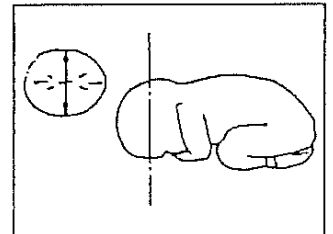

(Example)	Parameter				
	BPD	:	04.7cm		Measurement of the parameter
		:	19W5d		Gestational age in weeks and days
			± 13d		Deviation from standard value in days
		:	89/10/21		Estimated date of confinement
	AVE : 19W5d ± 13d	:	89/10/21		Average of all the parameters. *This appears even if only one calculation is done.

The + mark disappears.

10. GESTATIONAL AGE CALCULATION  
10.3 Parameter Method

---

The menu returns to PAGE-1.

OB-MEASUR					
PAGE-1	CLEAR	BPD	CRL	FL	NEXT

- e. If you want to measure the BPD again, select BPD again. The data is reset.
- f. When you want to measure another parameter, select another parameter in the menu. Up to three parameters can be measured and their average of them displayed.
- g. To terminate the calculation and erase data display, select **CLEAR**.
- h. To erase the menu, press the **OB-CAL** switch.

(2) When the measurement is done before parameter selection

- a. Measure the parameter you desire.  
you can measure multiple parameters at this stage.
- b. Press the **OB-CAL** switch.  
The following menu is displayed:

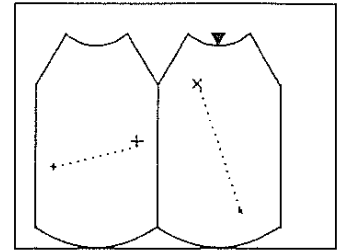

```
OB-MEASUR
PAGE-1    CLEAR    BPD    CRL    FL    NEXT
```

If you want AC and HC, select **NEXT** to display the next page of the menu.

- c. Select a parameter in the menu that corresponds to the parameter you have measured.

The measurement value displayed at the top is highlighted.  
Calculated values of the highlighted parameter are displayed.

```
DISTANCE
+:09.0cm
X:10.5cm
```

- d. If the highlighted value is not the one you want, press the **MARK REF** switch until the appropriate value is highlighted.  
Calculated values of the highlighted parameter are displayed.

```
DISTANCE
+:09.0cm
X:10.5cm
```

**NOTE:** If none of the measurement values are appropriate for the calculation, press the **MARK REF** switch until the highlighting is placed at the bottom, then press it once again. Perform measurement with the displayed caliper mark. Then select **SET** in the menu.

- e. To use another parameter for the calculation, repeat steps c and d.
- f. To terminate the calculation and erase the result display, select **CLEAR**.

(Example)

Parameter		Measurement of the parameter
CRL : 04.5cm	BPD : 04.5cm	
:19W2d	:19W2d	Gestational age in weeks and days
±10d	±10d	Deviation from standard value in days
:89/12/31	:89/12/31	Estimated date of confinement
AVE : 19W2d±10d	:89/12/31	Average of all the parameters. *This appears even if only one calculation is done.

## 10.4 Fetal Growth Tables

### Contents

	Page
USA version	
BPD (Kurtz) .....	10-13
CRL (Robinson) .....	10-13
FL (O'Brien) .....	10-14
AC (Hadlock) .....	10-14
HC (Hadlock) .....	10-15
Europe I version (Hansmann)	
BPD .....	10-16
CRL .....	10-16
FL .....	10-17
HL .....	10-17
Tokyo University version	
BPD .....	10-19
CRL .....	10-19
GS .....	10-19
LV .....	10-20
F .....	10-20
Osaka University version	
BPD .....	10-21
CRL .....	10-21
FTA .....	10-22
FL .....	10-22
HL .....	10-23
Europe II version (Campbell)	
BPD .....	10-25
FL .....	10-25
AC .....	10-26
HC .....	10-26

10. GESTATIONAL AGE CALCULATION  
10.4 Fetal Growth Table

USA Version

USA Version

Crown-Rump Length  
Robinson

Biparietal Diameter  
Kurtz

BPD (cm)	Number of Weeks	Standard Deviation ( $\pm$ days)
2.0	12	
2.3	13	
2.7	14	
3.1	15	
3.4	16	
3.8	17	
4.1	18	
4.5	19	
4.8	20	
5.1	21	
5.4	22	
5.7	23	
6.0	24	
6.3	25	
6.6	26	
6.8	27	
7.1	28	
7.4	29	
7.6	30	
7.8	31	
8.1	32	
8.3	33	
8.5	34	
8.7	35	
8.9	36	
9.1	37	
9.2	38	
9.4	39	
9.6	40	

CRL (cm)	Number of Weeks	Standard Deviation ( $\pm$ days)
0.9	7	5
1.5	8	5
2.2	9	5
3.1	10	5
4.0	11	5
5.2	12	5
6.4	13	5
7.8	14	5

10. GESTATIONAL AGE CALCULATION

10.4 Fetal Growth Table

USA Version

**USA version**

Femur Length  
O'Brien

FL (cm)	Number of Weeks	Standard Deviation (±days)
1.3	13	
1.7	14	
2.0	15	
2.2	16	
2.6	17	
3.0	18	
3.3	19	
3.5	20	
3.8	21	
4.1	22	
4.4	23	
4.6	24	
4.8	25	
5.1	26	
5.3	27	
5.5	28	
5.7	29	
5.9	30	
6.1	31	
6.3	32	
6.5	33	
6.6	34	
6.8	35	
7.0	36	
7.1	37	
7.2	38	
7.4	39	

Abdominal Circumference  
Hadlock

AC (cm)	Number of Weeks	Standard Deviation (±days)
10.4	16	13
11.6	17	13
12.8	18	14
13.9	19	14
15.0	20	14
16.2	21	14
17.3	22	14
18.4	23	14
19.5	24	15
20.6	25	15
21.6	26	15
22.7	27	15
23.8	28	15
24.8	29	15
25.9	30	21
26.9	31	21
27.9	32	21
28.9	33	21
29.9	34	21
30.9	35	21
31.9	36	18
32.9	37	18
33.9	38	18
34.8	39	18
35.8	40	18



USA Version

**USA Version**

Head Circumference  
 Hadlock

HC (cm)	Number of Weeks	Standard Deviation (±days)
9.0	14	9
10.5	15	9
12.1	16	9
13.5	17	9
14.9	18	11
16.3	19	11
17.5	20	11
18.8	21	11
19.9	22	11
21.0	23	11
22.1	24	11
23.1	25	16
24.1	26	16
25.1	27	16
26.0	28	16
26.9	29	16
27.7	30	19
28.5	31	19
29.3	32	19
30.1	33	19
30.9	34	19
31.6	35	19
32.3	36	19
33.0	37	24
33.7	38	24
34.4	39	24
35.0	40	24
35.6	41	24

10. GESTATIONAL AGE CALCULATION

10.4 Fetal Growth Table

Europe I version (Hansmann)

Europe I version (Hansmann)

Biparietal Diameter

BPD (cm)	Number of Weeks	Standard Deviation (±days)
2.9	13	8
3.1	14	8
3.4	15	9
3.7	16	8
4.0	17	9
4.3	18	9
4.6	19	9
5.0	20	10
5.3	21	11
5.6	22	10
5.9	23	10
6.2	24	10
6.5	25	10
6.8	26	10
7.1	27	12
7.4	28	12
7.7	29	13
8.0	30	15
8.2	31	15
8.4	32	17
8.6	33	17
8.8	34	19
9.0	35	19
9.2	36	24
9.3	37	22
9.5	38	22
9.7	39	22
10.3	40	19

Crown-Rump Length

CRL (cm)	Number of Weeks	Standard Deviation (±days)
0.6	6	7
1.0	7	7
1.5	8	7
2.1	9	7
2.8	10	8
3.7	11	8
4.8	12	9
6.3	13	10
7.8	14	11
9.1	15	12
10.3	16	13
11.3	17	14
12.3	18	14
13.2	19	15
14.0	20	16
14.8	21	16

Europe I version (Hansmann)

Europe I version (Hansmann)

Femur Length

FL (cm)	Number of Weeks	Standard Deviation ( $\pm$ days)
1.4	14	7
1.7	15	7
2.0	16	8
2.3	17	9
2.6	18	10
2.9	19	11
3.2	20	11
3.5	21	12
3.8	22	13
4.0	23	13
4.3	24	14
4.5	25	14
4.8	26	15
5.0	27	15
5.3	28	16
5.5	29	17
5.7	30	18
5.9	31	19
6.2	32	20
6.4	33	20
6.6	34	21
6.8	35	22
7.0	36	23
7.2	37	24
7.4	38	25
7.6	39	26

Humerus Length

HL (cm)	Number of Weeks	Standard Deviation ( $\pm$ days)
1.1	13	19
1.4	14	19
1.7	15	19
2.0	16	20
2.3	17	19
2.5	18	19
2.8	19	20
3.0	20	19
3.3	21	19
3.5	22	20
3.7	23	20
3.9	24	19
4.1	25	20
4.3	26	20
4.5	27	20
4.7	28	20
4.9	29	20
5.1	30	20
5.3	31	20
5.5	32	20
5.7	33	20
5.9	34	19
6.1	35	20
6.3	36	19
6.5	37	20
6.7	38	20
6.9	39	19

## 10. GESTATIONAL AGE CALCULATION

### 10.4 Fetal Growth Table

---

Tokyo University Version

Biparietal Diameter

BPD (cm)	Number of Weeks	Standard Deviation (±days)
2.0	12	7
2.4	13	7
2.7	14	7
3.1	15	7
3.4	16	8
3.8	17	8
4.1	18	9
4.4	19	10
4.7	20	10
5.0	21	10
5.3	22	10
5.6	23	11
5.9	24	11
6.2	25	12
6.5	26	13
6.7	27	13
7.0	28	13
7.2	29	14
7.5	30	15
7.7	31	16
7.9	32	16
8.2	33	18
8.4	34	20
8.5	35	25
8.7	36	25
8.8	37	25
8.9	38	25
9.0	39	25
9.1	40	25

Crown-Rump Length

CRL (cm)	Number of Weeks	Standard Deviation (±days)
1.5	8	7
1.9	9	7
2.7	10	7
3.6	11	7
4.6	12	7
5.7	13	7
7.2	14	8
8.7	15	14
9.8	16	14
10.3	17	14

Gestational Sac

GS (cm)	Number of Weeks	Standard Deviation (±days)
1.0	4	7
1.6	5	8
2.2	6	11
2.7	7	12
3.4	8	13
4.1	9	14
4.8	10	15
5.7	11	16
6.7	12	17

10. GESTATIONAL AGE CALCULATION

10.4 Fetal Growth Table

Tokyo University

Tokyo University Version

Length of Vertebrae

LV (cm)	Number of Weeks	Standard Deviation (±days)
3.7	21	7
4.0	22	9
4.4	23	11
4.7	24	12
5.0	25	14
5.4	26	17
5.7	27	19
5.9	28	21
6.2	29	24
6.4	30	25
6.7	31	28
6.9	32	31
7.1	33	34
7.3	34	35
7.5	35	38
7.7	36	40
7.8	37	42
7.9	38	44
8.0	39	46
8.1	40	48

Femur Length

FL (cm)	Number of Weeks	Standard Deviation (±days)
3.1	20	17
3.3	21	18
3.5	22	19
3.8	23	21
4.0	24	22
4.3	25	24
4.6	26	25
4.8	27	25
5.0	28	25
5.2	29	28
5.5	30	30
5.7	31	32
5.9	32	35
6.0	33	38
6.2	34	42
6.4	35	46
6.5	36	50
6.7	37	54
6.8	38	57
6.9	39	60
7.0	40	64

Osaka University Version

Crown-Rump Length

Biparietal Diameter

Gestational Age (weeks)	BPD (cm)	Standard Deviation
10	1.3	0.19
11	1.7	0.20
12	2.1	0.21
13	2.5	0.22
14	2.8	0.23
15	3.2	0.24
16	3.5	0.25
17	3.9	0.26
18	4.2	0.27
19	4.5	0.28
20	4.8	0.29
21	5.2	0.29
22	5.5	0.30
23	5.8	0.31
24	6.1	0.32
25	6.4	0.32
26	6.7	0.33
27	7.0	0.34
28	7.2	0.34
29	7.5	0.35
30	7.7	0.35
31	8.0	0.36
32	8.2	0.36
33	8.4	0.37
34	8.6	0.37
35	8.8	0.37
36	9.0	0.38
37	9.1	0.38
38	9.2	0.38
39	9.3	0.39
40	9.4	0.39

Gestational Age (weeks)	CRL (cm)	Standard Deviation
7	0.9	0.16
8	1.3	0.26
9	2.0	0.37
10	3.0	0.48
11	4.1	0.58
12	5.3	0.69
13	6.5	0.79

10. GESTATIONAL AGE CALCULATION

10.4 Fetal Growth Table

Osaka University

Osaka University Version

Femur Length

Fetal Trunk Area

Gestational Age (weeks)	FTA (cm <sup>2</sup> )	Standard Deviation
14	5.6	1.18
15	7.3	1.37
16	9.2	1.58
17	11.3	1.80
18	13.5	2.03
19	15.8	2.28
20	18.4	2.53
21	21.0	2.81
22	23.8	3.09
23	26.8	3.39
24	29.9	3.70
25	33.1	4.02
26	36.5	4.36
27	39.9	4.71
28	43.4	5.07
29	47.1	5.45
30	50.8	5.83
31	54.5	6.24
32	58.3	6.65
33	62.1	7.08
34	65.8	7.52
35	69.5	7.97
36	73.2	8.44
37	76.8	8.92
38	80.2	9.41
39	83.5	9.92
40	86.6	10.44

Gestational Age (weeks)	FL (cm)	Standard Deviation
13	0.9	0.21
14	1.3	0.22
15	1.6	0.22
16	1.9	0.22
17	2.2	0.23
18	2.5	0.23
19	2.8	0.24
20	3.0	0.24
21	3.3	0.24
22	3.6	0.25
23	3.8	0.25
24	4.1	0.25
25	4.3	0.26
26	4.6	0.26
27	4.8	0.27
28	5.0	0.27
29	5.2	0.27
30	5.4	0.28
31	5.6	0.28
32	5.8	0.29
33	6.0	0.29
34	6.2	0.29
35	6.4	0.30
36	6.5	0.30
37	6.7	0.31
38	6.8	0.31
39	7.0	0.31
40	7.1	0.32



Osaka University Version

Humeral Length

Gestational Age (weeks)	HL (cm)	Standard Deviation
13	1.0	0.20
14	1.3	0.21
15	1.6	0.21
16	1.9	0.21
17	2.1	0.22
18	2.4	0.22
19	2.7	0.22
20	2.9	0.23
21	3.2	0.23
22	3.4	0.23
23	3.6	0.24
24	3.8	0.24
25	4.0	0.24
26	4.2	0.25
27	4.4	0.25
28	4.6	0.25
29	4.8	0.26
30	4.9	0.26
31	5.1	0.26
32	5.3	0.27
33	5.4	0.27
34	5.5	0.27
35	5.7	0.28
36	5.8	0.28
37	5.9	0.28
38	6.0	0.29
39	6.1	0.29
40	6.2	0.29



Europe I version (Campbell)

Europe II version (Campbell)

Biparietal Diameter

BPD (cm)	Number of Weeks	Standard Deviation ( $\pm$ days)
2.3	13	4
2.8	14	5
3.2	15	6
3.7	16	7
4.0	17	7
4.3	18	7
4.7	19	7
5.1	20	8
5.4	21	8
5.8	22	8
6.1	23	8
6.4	24	8
6.7	25	8
7.0	26	9
7.3	27	10
7.5	28	11
7.8	29	12
8.0	30	13
8.2	31	14
8.5	32	14
8.7	33	15
8.9	34	15
9.1	35	16
9.3	36	17
9.5	37	18
9.7	38	19
9.8	39	20
10.0	40	21
10.2	41	22

Femur Length

FL (cm)	Number of Weeks	Standard Deviation ( $\pm$ days)
1.5	14	6
1.8	15	6
2.2	16	6
2.5	17	6
2.7	18	6
3.0	19	6
3.3	20	7
3.6	21	7
3.9	22	8
4.2	23	8
4.5	24	8
4.7	25	9
4.9	26	10
5.2	27	11
5.4	28	12
5.6	29	13
5.8	30	14
6.0	31	15
6.2	32	16
6.4	33	18
6.6	34	20
6.8	35	22
7.0	36	26
7.1	37	28
7.2	38	30
7.4	39	32
7.5	40	32

10. GESTATIONAL AGE CALCULATION

10.4 Fetal Growth Table

Europe I version (Campbell)

**Europe II version (Campbell)**

Abdominal Circumference

AC (cm)	Number of Weeks	Standard Deviation (±days)
9.1	14	14
10.1	15	15
11.2	16	15
12.3	17	16
13.3	18	16
14.4	19	17
15.5	20	17
16.6	21	18
17.7	22	18
18.8	23	19
19.9	24	19
21.0	25	20
22.0	26	20
23.1	27	21
24.2	28	21
25.3	29	22
26.4	30	23
27.5	31	25
28.6	32	35
29.7	33	35
30.8	34	35
31.6	35	35
32.4	36	35
33.1	37	35
33.8	38	35
34.4	39	35
35.0	40	35

Head Circumference

HC (cm)	Number of Weeks	Standard Deviation (±days)
11.6	14	12
12.6	15	12
13.7	16	12
14.8	17	12
15.9	18	12
17.0	19	12
18.1	20	13
19.2	21	14
20.4	22	15
21.5	23	16
22.6	24	17
23.7	25	18
24.8	26	19
26.0	27	20
27.1	28	21
28.1	29	22
29.0	30	25
29.9	31	28
30.7	32	35
31.4	33	35
32.0	34	35
32.5	35	35
33.0	36	35
33.5	37	35
34.0	38	35
34.2	39	35
34.3	40	35

**Section 11**

**FETAL WEIGHT ESTIMATION**



## 11. FETAL WEIGHT ESTIMATION

### 11.1 Introduction

The fetal weight is estimated from such measured values as biparietal diameter (BPD), anteroposterior trunk diameter (APTD), and transverse trunk diameter (TTD).

For fetal weight estimation, one of the following four expressions is available. Units are cm for length and cm<sup>2</sup> for area.

<USA version>

(Shepard method)

$$FW (g) = 10EXP [(AC \times 0.046) - (BPD \times AC \times 0.002646) + (BPD \times 0.166) + 1.2508]$$

(Hadlock method '85)

$$FW (g) = 10EXP [1.304 + (AC \times 0.05281) + (FL \times 0.1938) - (AC \times FL \times 0.004)]$$

<Europe version>

(Shepard method)

$$FW (g) = 10EXP [(AC \times 0.046) - (BPD \times AC \times 0.002646) + (BPD \times 0.166) + 1.2508]$$

<Tokyo University version>

$$FW (g) = 1.07 \times (BPD)^3 + 3.42 \times APTD \times TTD \times F$$

<Osaka University version>

$$FW (g) = 1.25647 \times (BPD)^3 + 3.50665 \times FTA \times FL + 6.3$$

#### List of abbreviations

BPD: Biparietal Diameter

APTD: Anteroposterior Trunk Diameter

FTA: Fetal Trunk Cross-Sectional Area

F (FL): Femur Length

TTD: Transverse Trunk Diameter

AC: Abdominal Circumference

# 11. FETAL WEIGHT ESTIMATION

## 11.1 Introduction

### <Reference>

#### Parts to be measured for fetal weight estimation

The figures below shows the measurement part necessary for the above expression.

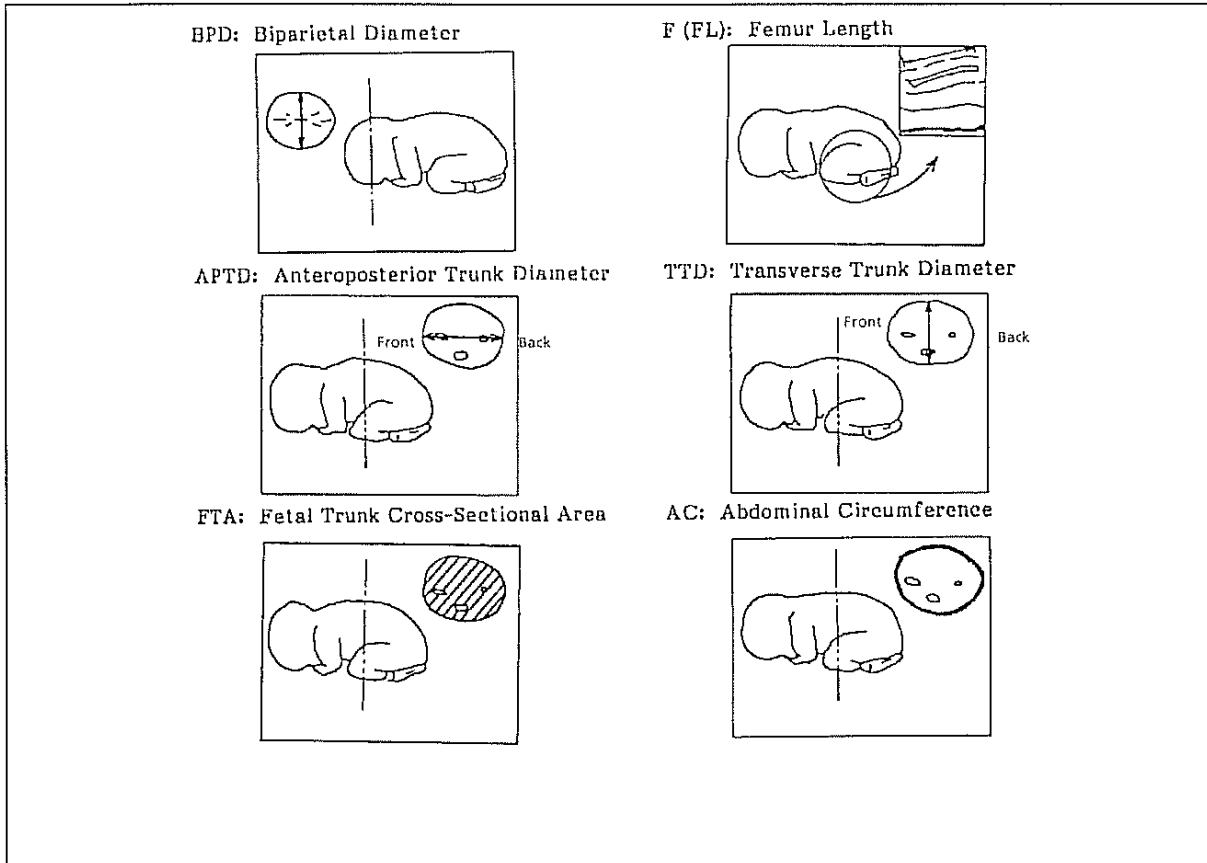



## 11.2 Shepard Method

**(1) Calculation method is selected before measurement.**

<Step>

- a. Press the **FETAL WEIGHT** switch.

The following menu is displayed:

(USA version)

SHEPRD	HADLOC	SET
--------	--------	-----

Select **SHEPRD**.

A + caliper mark appears at the center of the screen.

AC is highlighted.

BPD:000.0cm	AC:	cm
	F-W	g

- b. Measure the BPD with the + caliper mark in the same manner as the distance measurement.

- c. Select **SET**. The BPD value is registered.

A area measurement mark appears on the screen.

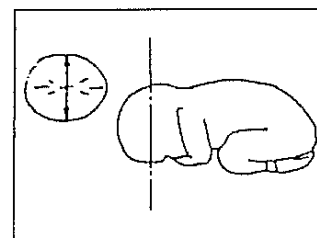

BPD:XXX.Xcm	AC:00.0cm	
	F-W	g

- d. Measure the **AC** in the same manner as area measurement.

- e. Select **SET**. The AC value is registered.

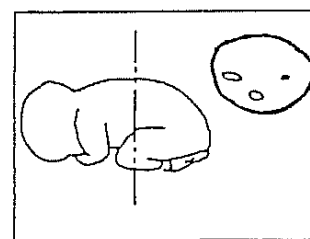

- f. Fetal weight is calculated and the result is displayed at F-W in grams.

BPD:XXX.Xcm	AC: XX.Xcm	
	F-W	XXXXg

- g. When you want to repeat the calculation, select **HADLOC**. The data is reset.

- h. To terminate the calculation and erase data display, press the **FETAL WEIGHT** switch.

# 11. FETAL WEIGHT ESTIMATION

## 11.2 Shepard Method

(2) Measurement is done before calculation method selection.

<Step>

- a. Measure parameters necessary for the calculation.
- b. Press the **FETAL WEIGHT** switch.  
The following menu is displayed.

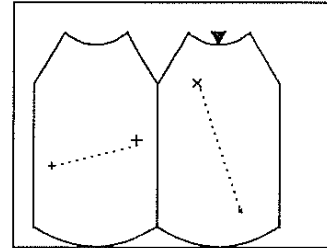

SHEPRD HADLOC SET

- c. Select **SHEPRD**.

The measured value at the top is highlighted.  
The highlighted value is put into BPD.

BPD:XXX.Xcm AC:00.0cm  
F-W g

- d. If the value is not suited to BPD, press the **MARK REF** switch to lower the highlighting till an appropriate value is highlighted.
- e. Select **SET**. The BPD value is registered.

The measured value at the top is highlighted.  
The highlighted value is put into AC.

BPD:XXX.Xcm AC:XX.Xcm  
F-W g

- f. If the value is not suited to AC, press the **MARK REF** switch to lower the highlighting till an appropriate value is highlighted.
- g. Select **SET**. The AC value is registered.
- h. Fetal weight is calculated and the result is displayed at F-W in grams.
- i. To terminate the calculation and erase data display, press the **FETAL WEIGHT** switch.

BPD:XXX.Xcm AC:XX.Xcm  
F-W XXXXg

### 11.3 Hadlock Method (USA version)

(1) Calculation method is selected before measurement.

<Step>

- a. Press the **FETAL WEIGHT** switch.  
The following menu is displayed.  
(USA version)

SHEPRD	HADLOC	SET
--------	--------	-----

Select **HADLOC**.

A + caliper mark appears at the center of the screen.  
AC is highlighted.

AC :000.0cm	FL:	cm
	F-W	g

- b. Measure the **AC** in the same manner as area measurement.
- c. Select **SET**. The AC value is registered.

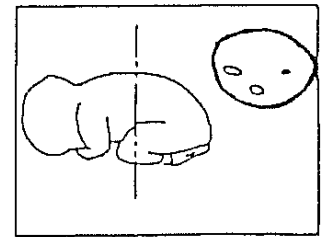

A + caliper mark appears on the screen.

AC :XXX.Xcm	FL:	cm
	F-W	g

- d. Measure the **FL** with the + caliper mark in the same manner as the distance measurement.
- e. Select **SET**. The FL value is registered.
- f. Fetal weight is calculated and the result is displayed at F-W in grams.

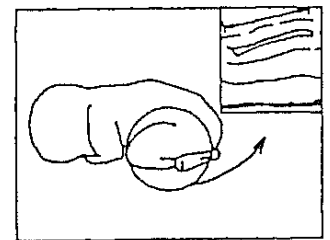

AC :XXX.Xcm	FL:XX.Xcm
F-W	XXXXg

- g. When you want to repeat the calculation, select **HADLOC**. The data is reset.
- h. To terminate the calculation and erase data display, press the **FETAL WEIGHT** switch.

11. FETAL WEIGHT ESTIMATION  
 11.3 Hadlock Method

(2) Measurement is done before calculation method selection.

<Step>

- a. Measure parameters necessary for the calculation.
- b. Press the **FETAL WEIGHT** switch.  
The following menu is displayed.

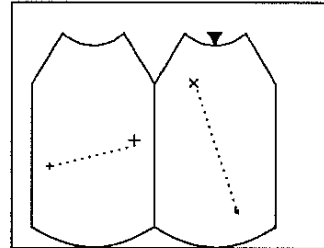

SHEPRD	HADLOC	SET
--------	--------	-----

- c. Select the method you want.

(When HADLOC is selected.)

Measured value at the top is highlighted.  
The highlighted value is put into AC.

AC :XXX.Xcm	FL:00.0cm
F-W	g

- d. If the value is not suited to AC, press the MARK REF switch to lower the highlighting till an appropriate value is highlighted.

- e. Select **SET**. The AC value is registered.

AC :XXX.Xcm	FL:XX.Xcm
F-W	g

Measured value at the top is highlighted.  
The highlighted value is put into FL.

- f. If the value is not suited to AC, press the MARK REF switch to lower the highlighting till an appropriate value is highlighted.

- g. Select **SET**. The FL value is registered.

- h. Fetal weight is calculated and the result is displayed at F-W in grams.

AC :XXX.Xcm	FL:XX.Xcm
F-W	XXXXg

- i. To terminate the calculation and erase data display, press the **FETAL WEIGHT** switch.

**Section 12**

**CHARACTER DISPLAY**



---

## 12. CHARACTER DISPLAY

### <Introduction>

The screen is divided into several display areas. (See the figure below.) Characters can be entered in the ID area and the image area.

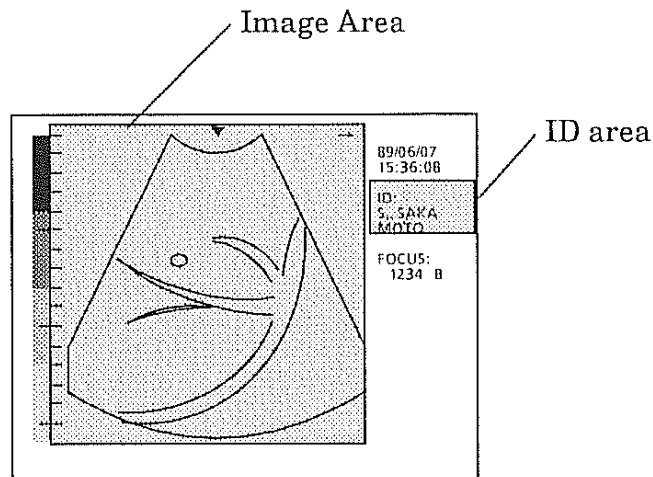

---

### Input area selection

---

1. ID area

- a. When the power is applied to the system, the character cursor (■) is displayed in the ID area.
- b. When the cursor is in the image area, press the ID switch on the keyboard. The cursor shifts to the ID area.

2. Image area

Press the **COMMENT** switch on the keyboard.

**NOTE:** The text in the first line in the image area is retained even after the power is turned off. The retained text is displayed when power is applied to the unit again.

## 12. CHARACTER DISPLAY

### 12.1 Introduction

---

#### Moving the character cursor

- a. The cursor (■) can be moved by the joypad (or trackball).
- b. The ← and → keys of the keyboard can shift the cursor to the left or right.
- c. To change line, press the RTN key.

#### How to use the keyboard

<To enter upper case symbols or European characters>

While you hold down the **SHIFT** key, press the key you want.

<To correct a displayed character>

- a. Press the **BS** (back space) key.
- b. Move the cursor onto the character to be corrected. Then press the correct key.

<To erase all the characters in the area>

Press the **AC** (all clear) key.

<To erase all the entered characters and reset the equipment parameters>

Press the **NEW PATIENT** key.

When the **NEW PATIENT** key is pressed, the equipment parameters are reset to those when the power is turned on. For the parameters that are controlled by this switch, see page 6-4.

#### Text retention

The text in the first line in the image area is retained even after the power is turned off.



**Section 13**

**RECORDING IMAGES**



## 13.1 VCR Recording

We recommend model AG-6400 as an optional video cassette recorder.

### (1) Connection

Connect the cables as follows:

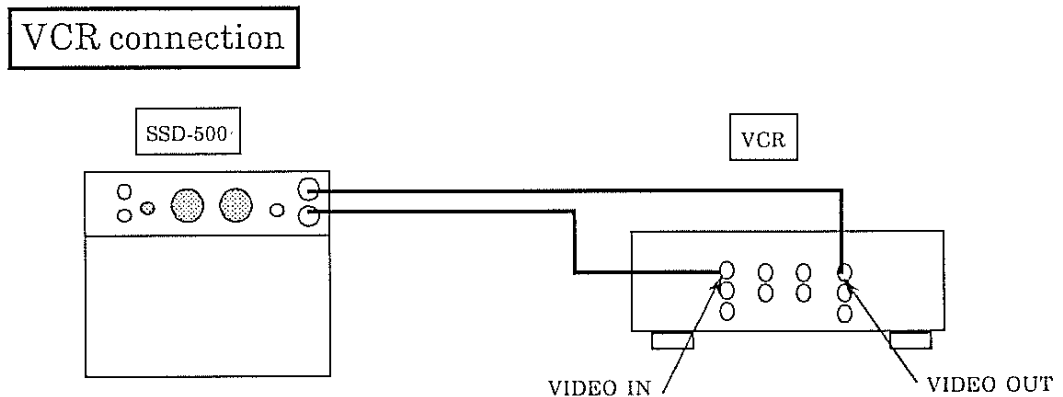

\* The connectors on the SSD-500 side accept BNC type connectors.

### (2) Step for Recording

- a. Turn on the power of VCR.  
Press the recording switch and pause switch. The VCR is in pause condition.
- b. Display ultrasound image on the scanner (SSD-500).  
Start recording of VCR.
- c. To observe playback image on the scanner screen, set the Video Source selector to EXT (up position).

**NOTE:** When you wish to use a VCR and a thermal printer, use Aloka thermal printer SSZ-300S. When a thermal printer or another type of printer does not have a VIDEO OUT connector, playback image cannot be seen on the scanner screen.

13. RECORDING IMAGES  
13.2 Thermal Printer (SSZ-300S)

---

## 13.2 Thermal Printer (SSZ-300S)

### (1) Connection

Connect the cables as follows:

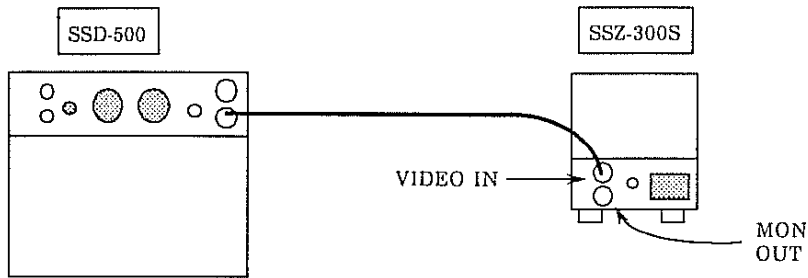

### (2) Step for Recording

- a. Turn on the power of the SSZ-300S.
- b. Display an ultrasound image on the scanner screen.  
Freeze the image with the **FREEZE** switch.
- c. Press the **PRINT** button of the printer.  
When the remote cable is connected, the **PRINT** switch on the SSD-500 operation panel performs the same function.

For details of operation of the SSZ-300S, see its operation manual.

To use a VCR or external monitor together with the SSZ-300S, make connections as illustrated on the next page.

13. RECORDING IMAGES  
13.2 Thermal Printer (SSZ-300S)

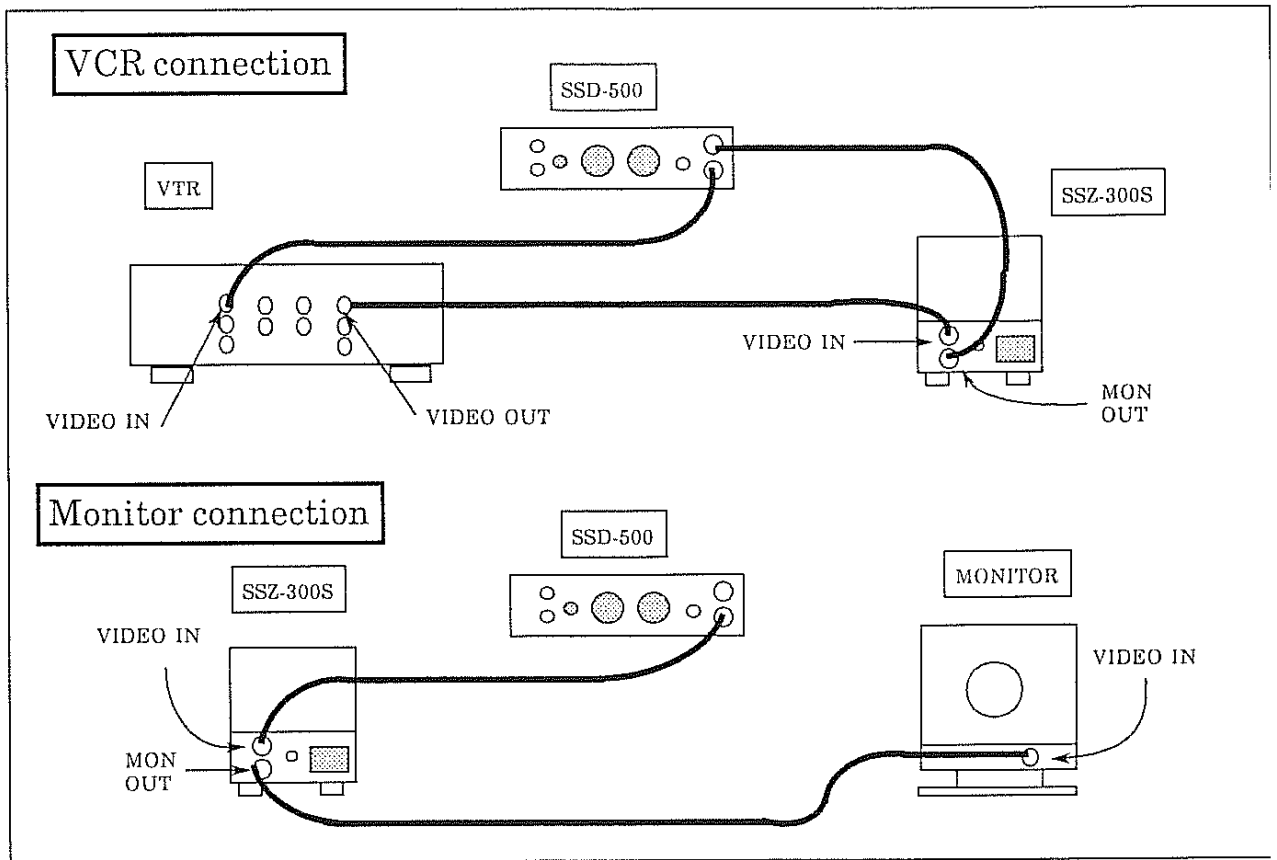

## 13. RECORDING IMAGES

### 13.3 Polaroid Camera Unit (SSZ-108U-P)

---

## 13.3 Polaroid Camera Unit (SSZ-108U-P)

#### (1) Connection

Connect the cables as follows:

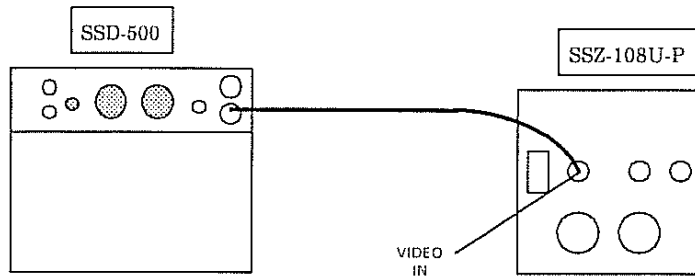

#### (2) Step for Recording

- a. Turn on the power of the SSZ-108U-P.  
Wait for several minutes until the SSZ-108U-P becomes stable.

**NOTE:** Pictures taken before the SSZ-108U-P is stable may be brighter or darker than the set condition.

- b. Display an ultrasound image on the scanner screen.  
Open the side door of the SSZ-108U-P and confirm that the image is displayed.

Freeze the image with the **FREEZE** switch.

Press the shutter button of the SSZ-108U-P. Pull the white tab of the Polaroid film.

Pull the yellow tab at a constant speed.

A few minutes later, peel off the film. (For the development time of the film, see the instructions of the film.)

If the picture is not taken in a good condition, see the operation manual of SSZ-108U-P and readjust the conditions.

**NOTE:** VCR or external monitors cannot be connected together with SSZ-108U-P.

## 13.4 SLR Camera Unit (SSZ-108U-35)

### (1) Connection

Connect the cables as follows:

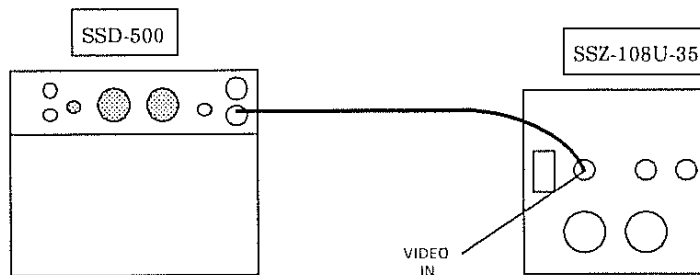

### (2) Step for Recording

- a. Turn on the power of the SSZ-108U-35.  
Wait for several minutes until the SSZ-108U-35 becomes stable.

NOTE: Pictures taken before the SSZ-108U-35 is stable may be brighter or darker than the set condition.

- b. Display an ultrasound image on the scanner screen.  
Open the side door of the SSZ-108U-35 and confirm that the image is displayed.

Freeze the image with the **FREEZE** switch.

Press the shutter button of the camera.

- c. If the picture is not taken in a good condition, see the operation manual of SSZ-108U-35 and readjust the condition.

NOTE: VCR or external monitors cannot be connected together with SSZ-108U-35.





**Section 14**

**TROUBLE SHOOTING**



## 14.1 Error Message

When an operation that cannot be accepted by the system is performed, the following messages appear. Take the appropriate countermeasure.

	Error message	Meaning	Countermeasure
1	No Probe	No probe is connected.	Connect a probe.
2	Inv.Probe	Invalid probe is connected.	Connect an appropriate probe for the system.
3	FRZ Req.	Freezing is requested.	This appears when you try to take a picture by pressing the PRINT switch without freezing the image. Freeze the image first.
4	Inv. Mode	Invalid operation.	This appears when ID or COMMENT key is pressed during "CGW/EDC" operation. (See PAGE10-2)
5	Inv. Mode	Invalid operation	During a measurement, SET is selected when not required.
6	Over Rng.	No space for measurement result display.	This appears when no more space for displaying measurement result is left.
7	Inv. Data	Invalid data	This appears when inappropriate date is entered for "CGW/EDC" operation. (See PAGE10-3) Enter correct date.

## 14. TROUBLE SHOOTING

### 14.2 How to Cope with Troubles

---

#### 14.2 How to Cope with Troubles

Phenomenon	Check point	Action
Nothing appears on the screen even if the power switch is turned on. (Power indicator does not light.)	Is power cord correctly connected between the unit and the outlet?	Connect the power cord.
	Does the outlet provide power?	Turn on the circuit breaker of the room.
Nothing appears on the screen. (Power indicator lights.)	Is the Video Source selector on the rear panel set to INT (down position)?	Set the Video Source selector to INT (down position).
Ultrasound image does not appear.	Is probe connected correctly?	Reconnect the probe, referring to page 6-2.

### 14.3 Calling Service Person

If your unit still doesn't work properly, check the serial number of your unit and call our distributor.

See the nameplate on the rear panel for the serial number.

The number is needed because parts, drawings and tools to be prepared for repair differ from version to version.

### CAUTIONS

Do not try to open the covers.

Do not loosen any screws.

If any cracks are found on the patient contact area or the cable of the probe, do not use the probe.

If the unit smells like burning or smoke is seen, immediately turn off the power switch, disconnect the power cord, and call a service person. Stick a paper on the unit saying "Out of order. Do not use."



## INDEX

+ switch 4-9, 9-1  
× switch 4-9, 9-1

### A

AC key 4-8, 12-2  
Area measurement data reading 9-5  
Area 9-3

### B

B mode 4-7, 7-1  
B/B mode 4-7, 7-12  
B/M mode 4-7, 8-1  
Back space 4-8, 12-2  
Battery 5-6  
BDY-MK 5-4, 7-10  
Body mark group 5-4, 7-10  
BODY MARK menu switch 4-7  
BODY MARK switch 4-4  
Brightness adjuster 4-10  
BRIGHTNESS control 4-2  
Brightness 7-3  
BS key 4-8, 12-2

### C

CALIPER MARK switches 4-5  
Caliper mark 9-1  
Camera hood 4-2  
Camera 13-4, 13-5  
Cardiac cycles 9-8  
Cautions 2-1, 14-3  
Character cursor 12-2  
Circumference 9-3  
Cleaning 2-3  
Clock 5-6  
COMMENT key 4-8  
CONNECTORS  
    footswitch 4-10  
    power cord 4-10  
    printer 4-10

trackball 4-10  
video signal 4-10  
Contrast adjuster 4-10  
CONTRAST control 4-2  
CONTROLS  
    BRIGHTNESS 4-2  
    CONTRAST 4-2  
    GAIN 4-2

### D

Data display 5-7  
DATE 5-5  
Dimension 9-6  
Dimensions of units 6-1  
Dots 8-1  
Dotted lines 8-1  
DT-DSP 5-7  
Dual B mode 4-7, 7-12

### E

Ellipse 9-5  
Elliptical mark 9-3  
Environment 6-1  
Equipment parameters 5-7, 7-1  
Error message 14-1  
EXT 4-10

### F

FAR GAIN switches 4-5  
FETAL WEIGHT switch 4-6  
Focal points 7-9  
FOCUS control 7-8  
FOCUS switch 4-6  
Footswitch connector 4-10  
Frame correlation 5-8  
FREEZE switch 4-8, 7-6, 8-6  
FRM-CO 5-8  
Frozen image 7-12

## INDEX

### G

GAIN control 4-2, 7-3, 8-3  
Gel 6-4

### H

H-RATE measurement data reading 9-9  
H-RATE 9-8  
Hadlock method 11-5  
Heart rate 9-8  
Heart 2-1  
Humidity 6-1

### I

ID area 12-1  
ID input 6-3  
ID switch 4-8  
Image area 12-1  
IMAGE DIRECTION switch 4-7, 7-5  
Image polarity 5-10  
IMG-DI 5-9  
IMG-PO 5-10  
Initial settings 6-5  
Input area selection 12-1  
Installation 6-1  
INT 4-10  
Inverted image 5-9

### J

Joypad 4-4

### K

Keyboard 4-8, 12-2

### M

M mode 4-7, 8-1  
M-CURS 5-11

M-mode cursor 5-11

MAGNIFICATION control 7-5, 8-5  
MAGNIFICATION switch 4-6  
MARK REF switch 4-5, 9-1  
MEASUREMENT switches 4-4  
Menu selection switches 4-2  
MENU switch 4-6  
MODE selection switches 4-7  
Monitor connection 13-3

### N

NEAR GAIN switches 4-5  
Negative image 5-10  
NEW PATIENT key 4-8, 12-2  
NEXT 5-2

### O

OB CAL switch 4-6

### P

Photography hood 4-2  
Polaroid camera 13-4  
POSITION switch 4-4, 7-6  
Power cord connection 6-2  
Power cord connector 4-10  
Power indicator 4-2  
Power on 6-3  
Power switch 4-10  
PRINT Switch 4-6  
Printer connector 4-10  
Printer 13-2  
Probe connection 6-2  
Probe mark rotation switches 4-5, 7-11  
Pulse 9-8  
PUNC 5-12  
Puncture guide line 5-12



## INDEX

### R

Real-time image 7-12  
Recording 13-1  
RTN 4-8

### S

Sampling line 8-1  
Scrolling 7-6  
Sensitivity time control 7-3, 8-3  
Serial number 14-3  
Shepard method 11-3  
SHIFT key 4-8, 12-2  
Size of unit 6-1  
SLR camera 13-5  
SPACE key 4-8  
STC control 7-3, 8-3

### SWITCHES

BODY MARK menu 4-7  
BODY MARK 4-4  
CALIPER MARK 4-5  
FAR GAIN 4-5  
FETAL WEIGHT 4-6  
FOCUS 4-6  
FREEZE 4-8  
ID 4-8  
IMAGE DIRECTION 4-7  
MAGNIFICATION 4-6  
MARK REF 4-5  
MEASUREMENT 4-4  
menu selection 4-2  
MENU 4-6  
NEAR GAIN 4-5  
OB CAL 4-6  
POSITION 4-4  
PRINT 4-6  
probe mark rotation 4-5

### T

Temperatur 6-1  
Thermal printer 13-1  
Time interval 9-6, 9-9  
Time 5-5  
Trackball connector 4-10  
Transportation 6-1  
Troubleshooting 14-1

### U

Ultrasound gel 6-4  
Uppercase 12-2  
Upside-down image 5-9

### V

VCR connection 13-3  
VEL measurement data reading 9-7  
Velocity 9-6  
Video signal connectors 4-10  
Video source selector 4-10  
VTR 4-10

