

SERVICE MANUAL

Nellcor Intouch

Remote Oximetry Notification System

Windows® and *Windows® CE* are registered trademarks of the Microsoft Corporation.

To obtain information about a warranty, if any, contact Nellcor Technical Services Department, 1.800.635.5267, or your local Nellcor representative.

Nellcor Puritan Bennett Inc. is an affiliate of Tyco Healthcare. *Nellcor* and *Intouch* are trademarks of Nellcor Puritan Bennett Inc.

TABLE OF CONTENTS

List of Figures

List of Tables

List of Figures	ii
List of Tables	iii
Section 1: Introduction	1-1
1.1 Manual Overview	1-1
1.2 Description of Intouch Remote Oximetry Notification System.....	1-1
1.3 Related Documents	1-5
Section 2: Routine Maintenance	2-1
2.1 Cleaning.....	2-1
2.2 Periodic Safety and Functional Checks.....	2-1
2.3 Battery	2-2
Section 3: Performance Verification.....	3-1
3.1 Introduction	3-1
3.2 Equipment Needed	3-1
3.3 Performance Verification	3-1
3.4 Safety Test.....	3-3
Section 4: Installation	4-1
4.1 Introduction	4-1
4.2 Intouch Transmitter Installation	4-1
4.3 Turning on the Intouch Transmitter	4-5
4.4 Pager and Bed Number Assignments	4-7
4.5 Testing Transmitter Range	4-13
Section 5: Troubleshooting	5-1
5.1 Introduction	5-1
5.2 How to Use This Section	5-1
5.3 Who Should Perform Repairs.....	5-1
5.4 Replacement Level Supported	5-1
5.5 Returning the Intouch Remote Oximetry Notification System	5-1
5.6 Obtaining Replacement Parts.....	5-2
5.7 Troubleshooting Guide	5-2
5.8 Restoring the Intouch Software on the Compaq Programmer	5-2
5.9 Error Messages	5-6
5.10 EMI (Electromagnetic Interference).....	5-7
Section 6: Site Survey And Installation Program.....	6-1
6.1 Introduction	6-1
6.2 Initial Installation Procedure	6-2
6.3 Intouch Install Program.....	6-5
Section 7: Spare Parts	7-1
7.1 Introduction	7-1
Section 8: Packing For Shipment	8-1
8.1 Introduction	8-1
8.2 General Instructions	8-1
Section 9: Specifications	9-1
9.1 System Specifications	9-1
9.2 Electrical	9-1
9.3 Environmental.....	9-3
9.4 Physical	9-3
Section 10: Technical Supplement	10-1
10.1 Introduction	10-1
10.2 Block Diagram	10-1
Section 11: Index.....	11-1

LIST OF FIGURES

Figure 1-1: Intouch Remote Oximetry Notification System..... 1-3
Figure 1-2: Transmitter Top View 1-3
Figure 1-3: Transmitter Front View 1-4
Figure 1-4: Transmitter Rear View..... 1-4
Figure 1-5: Pager Front View..... 1-4
Figure 1-6: Programmer Front View 1-5
Figure 1-7: Programmer Side View 1-5
Figure 3-1: Intouch Transmitter 3-2
Figure 3-2: Communication OK Page..... 3-3
Figure 3-3: Test Page 3-3
Figure 4-1: Intouch Transmitter Front View 4-2
Figure 4-2: Intouch Components 4-3
Figure 4-3: Transmitter Placement – N-395/595 4-4
Figure 4-4: Transmitter Rear View..... 4-4
Figure 4-5: Transmitter Top View 4-5
Figure 4-6: Transmitter Front View 4-6
Figure 4-7: Test Page 4-7
Figure 4-8: Programmer 4-8
Figure 4-9: 3-button Screen..... 4-8
Figure 4-10: Assignment Program Main Screen 4-9
Figure 4-11: Transmitter Data Loaded..... 4-9
Figure 4-12: Programming Successful 4-11
Figure 4-13: Start Button 4-11
Figure 4-14: Transmitter Program Main Screen 4-12
Figure 4-15: Transmitter Program Main Screen 4-12
Figure 4-16: Transmitter Programming Successful 4-13
Figure 4-17: Programmer On/Off Button 4-14
Figure 4-18: 3-button Screen..... 4-15
Figure 4-19: Transmitter Program Main Screen 4-15
Figure 4-20: Survey Page Display 4-16
Figure 5-1: Removing the Flash Card Slot Cover..... 5-2
Figure 5-2: Inserting the Flash Card 5-3
Figure 6-1: Programmer Power Switch..... 6-5
Figure 6-2: Start Button 6-6
Figure 6-3: Password Screen 6-6
Figure 6-4: Installation Program Alarms Screen..... 6-7
Figure 6-5: Transmitter Data Loaded Status Message..... 6-8
Figure 6-6: Pagers Selection Page Display 6-9
Figure 6-7: Alarms Screen 6-10
Figure 6-8: Pagers Configuration Screen 6-11
Figure 6-9: Monitor Configuration Screen..... 6-12
Figure 6-10: Sending Program Data Status Screen 6-13
Figure 6-11: Programming Successful Status Screen..... 6-13
Figure 6-12: Survey Paging Started Status Screen..... 6-14
Figure 6-13: Transmitter Top View 6-15
Figure 6-14: Programmer Power On/Off Button 6-16
Figure 6-15: Password Screen 6-16
Figure 6-16: Enter Current Password Screen 6-17
Figure 6-17: Installation Program Password Screen 6-17
Figure 7-1: Intouch Remote Oximetry Notification System..... 7-2
Figure 10-1: Intouch Block Diagram 10-1

LIST OF TABLES

Table 3-1: Enclosure Leakage Current Limits..... 3-4
Table 4-1: POST Light Sequence 4-6
Table 5-1: Transmitter Error Messages 5-6
Table 6-1: Survey Pages Intervals..... 6-12
Table 6-2: Number of Survey Pages..... 6-12
Table 7-1: Parts List..... 7-1

Blank Page

SECTION 1: INTRODUCTION

1.1 Manual Overview.....	page 1-1
1.2 Description of Intouch Remote Oximetry Notification System	page 1-1
1.3 Related Documents.....	page 1-5

1.1 MANUAL OVERVIEW

The most recent revision of the *Intouch* manuals is available on the Internet at:

http://www.mallinckrodt.com/respiratory/resp/Serv_Supp/ProductManuals.html

This manual contains information for servicing the Intouch remote oximetry notification system. Only qualified service personnel should service this product. Before servicing the Intouch remote oximetry notification system, read the operator's manual carefully for a thorough understanding of operation.

WARNING: Explosion hazard. Do not use the Intouch remote oximetry notification system in the presence of flammable anesthetics.
--

1.2 DESCRIPTION OF INTOUCH REMOTE OXIMETRY NOTIFICATION SYSTEM

Caution: When connecting the Intouch remote oximetry notification system to any monitor, verify proper operation before clinical use. Both the Intouch remote oximetry notification system transmitter and the monitor connected to it must be connected to a grounded outlet. Accessory equipment connected to the monitor's data interface must be certified according to IEC Standard 950 for data-processing equipment or IEC Standard 60601-1 for electromedical equipment. All combinations of equipment must be in compliance with IEC Standard 60601-1-1 systems requirements. Anyone who connects additional equipment to the oximeter signal input port or signal output port configures a medical system and is therefore responsible that the system complies with the requirements of system standard IEC Standard 60601-1-1 and the electromagnetic compatibility system standard IEC Standard 60601-1-2.

Caution: Whenever an Intouch remote oximetry notification system transmitter is moved, perform the performance verification procedures in paragraph 3.3 to ensure there are no interference problems. Whenever transmitting equipment is installed near an Intouch remote oximetry notification system transmitter, perform the performance verification procedures in paragraph 3.3 while the other transmitter is transmitting to ensure there are no interference problems.

The Intouch remote oximetry notification system is an alarm notification system intended for use in real-time monitoring of routine patient status and alarm events from the Nellcor NPB-290, NPB-295, N-395, and N-595¹ pulse oximetry monitors. It serves as a parallel, redundant mechanism to inform the clinical staff of patient events. It is intended to supplement and not to replace any part of the current device monitoring procedures.

The intended patient population comprises adult, pediatric, and neonatal patients. The intended environments of use are hospitals and hospital-type facilities. Hospital use typically covers such areas as general care floors, operating rooms, special procedure areas, intensive and critical care areas, within the hospital plus hospital-type facilities such as surgicenters, sub-acute centers, special nursing facilities, and sleep labs, outside of the hospital. The Intouch is for prescription use only.

The Intouch remote oximetry notification system is not considered to be diagnostic without skilled interpretation and does not replace physician's care.

The Intouch remote oximetry notification system (Figure 1-1) is comprised of three basic components:

- Intouch Transmitter, Figure 1-2 through Figure 1-4
- Intouch Pager, Figure 1-5
- Intouch Programmer, Figure 1-6 and Figure 1-7

The Intouch transmitter connects to an NPB-290, NPB-295, N-395, or N-595¹ pulse oximeter with the appropriate cable. When the pulse oximeter goes into alarm, the transmitter transmits that alarm to a designated pager or pagers.

WARNING: An Intouch system must always consist of at least two pagers, so that if one pager is temporarily not receiving messages (for example, because batteries are exhausted or the user is out of range) and no one silences the alarm at the monitor, the second pager will be notified via a reminder page.

The Intouch pager is worn by a caregiver. When the pager receives an alarm page it beeps or vibrates and displays the patient bed number, alarm type, and patient monitored parameters. Pagers must be separated from each other, by at least 4 inches, to eliminate interference between pagers.

The Intouch programmer is used to set up the Intouch remote oximetry notification system.

Note: Your programmer (see Figure 1-6) may look somewhat different than the one illustrated here. However, the only buttons you will need when using it with the Intouch transmitter are the Power button, the far left Application button, and the Q button on the side (see Figure 1-7). The other three application buttons are not used with the Intouch system.

¹ The N-595 must have software version 2.4.6 or lower to work with the Intouch system.

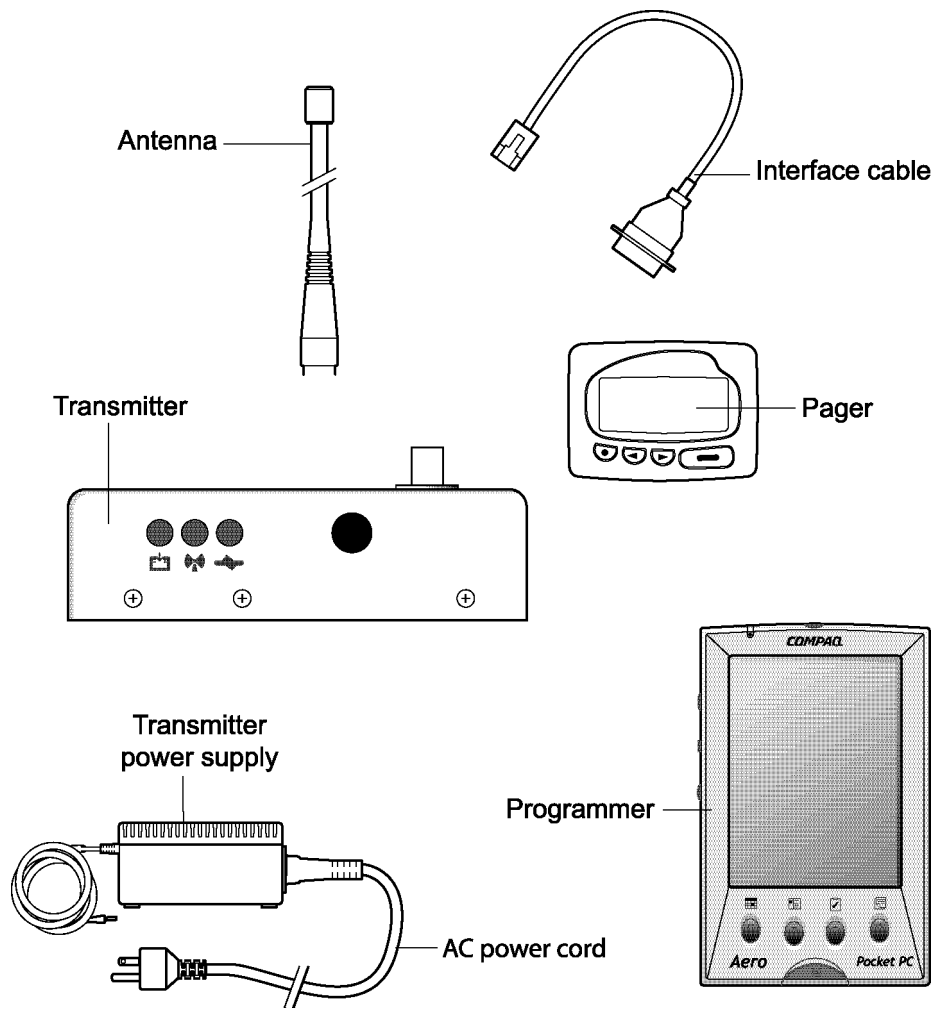

Figure 1-1: Intouch Remote Oximetry Notification System

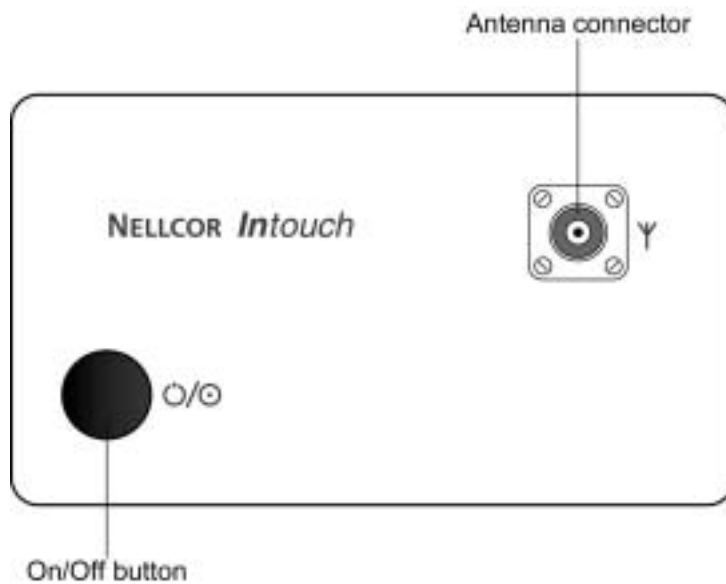

Figure 1-2: Transmitter Top View

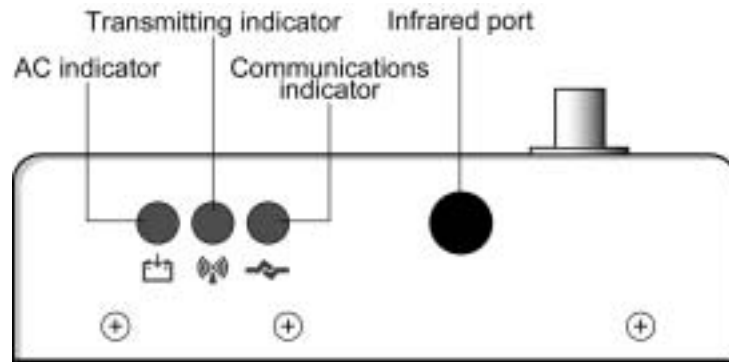

Figure 1-3: Transmitter Front View

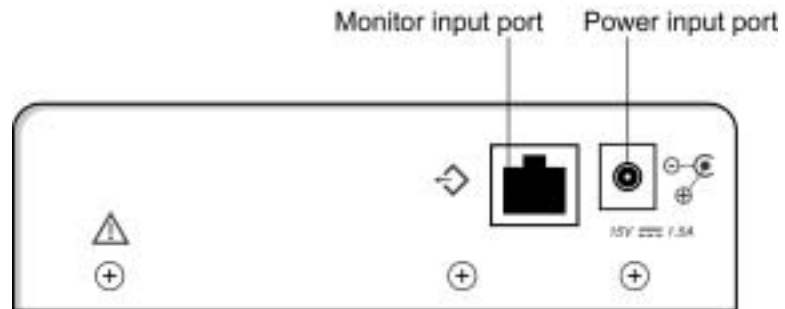

Figure 1-4: Transmitter Rear View

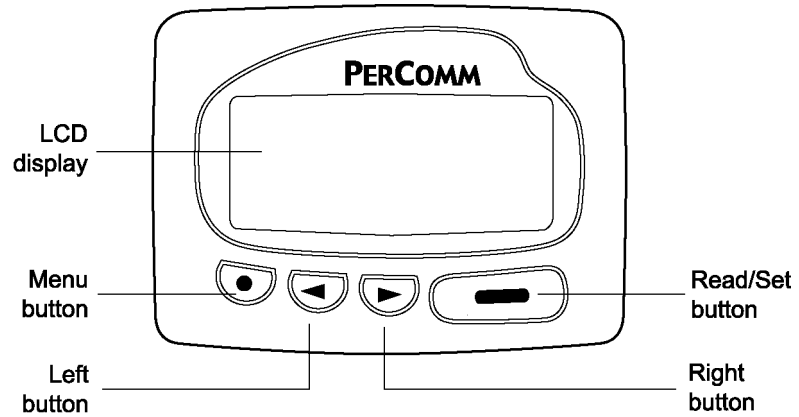

Figure 1-5: Pager Front View

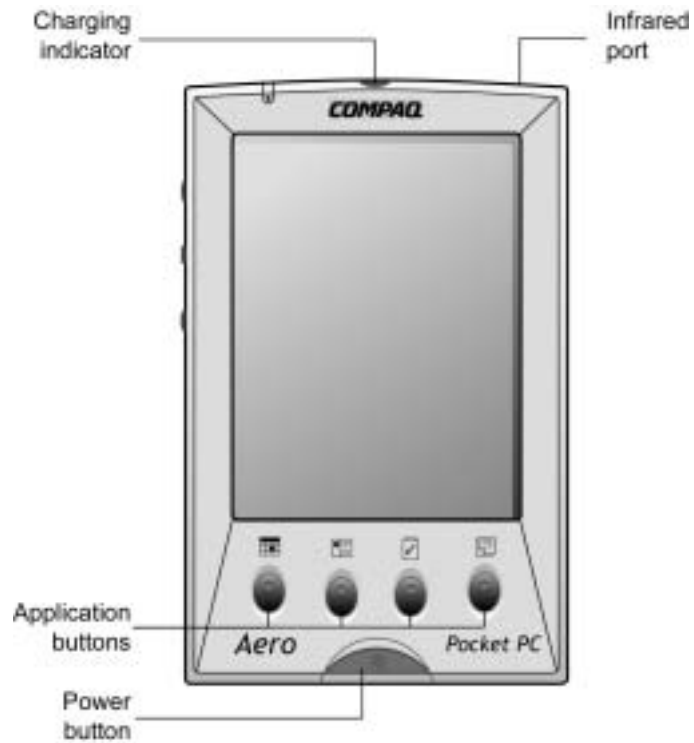

Figure 1-6: Programmer Front View

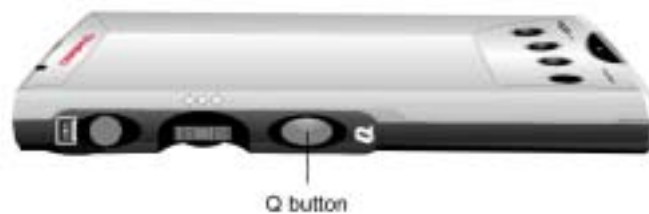

Figure 1-7: Programmer Side View

1.3 RELATED DOCUMENTS

To perform test and troubleshooting procedures, and to understand the principles of operation and circuit analysis sections of this manual, you must know how to operate the Intouch remote oximetry notification system. Refer to the Intouch remote oximetry notification system operator's manual. The most recent copy of the operator's manual is available on the Internet at:

http://www.mallinckrodt.com/respiratory/resp/Serv_Supp/ProductManuals.html

Blank Page

SECTION 2: ROUTINE MAINTENANCE

2.1 Cleaning page 2-1
2.2 Periodic Safety and Functional Checks page 2-1
2.3 Battery page 2-2

2.1 CLEANING

Caution: Do not spray, pour, or spill any liquid on any of the Intouch components, its accessories, connectors, switches, or openings in the chassis.

Caution: Do not immerse the components of the Intouch remote oximetry notification system in liquid or clean with caustic or abrasive cleaners. Do not spray or pour any liquid on the components of the Intouch remote oximetry notification system.

2.1.1 Transmitter

For surface-cleaning and disinfecting follow your institution’s procedures or:

- The transmitter may be surface-cleaned by using a soft cloth dampened with either a commercial, nonabrasive cleaner or a solution of 70% alcohol in water, and lightly wiping the surfaces of the transmitter.
- The transmitter may be disinfected using a soft cloth saturated with 10% chlorine bleach in tap water solution.

2.1.2 Programmer

To clean the programmer screen, use a clean cloth designed for use on lenses or touch-sensitive screens. To clean the casing, use a clean damp cloth. Wipe dry with a dry cloth.

2.1.3 Pager

To clean the pager screen, use a clean cloth designed for use on lenses or touch-sensitive screens. To clean the casing, use a clean damp cloth. Wipe dry with a dry cloth.

2.2 PERIODIC SAFETY AND FUNCTIONAL CHECKS

The following checks should be performed at least every 2 years by qualified service technicians.

1. Inspect the exterior of the Intouch equipment for damage.
2. Inspect the safety labels for legibility. If the labels are not legible, contact Nellcor Technical Services Department or your local Nellcor representative.
3. Verify that the units perform properly as described in paragraph 3.3.
4. Perform the electrical safety tests detailed in paragraph 3.4. If the unit fails these electrical safety tests, do not attempt to repair the unit. Contact Nellcor Technical Services Department or your local Nellcor representative.

2.3 BATTERY

2.3.1 Transmitter

The transmitter needs to be returned to Nellcor for battery replacement. Refer to *Returning the Intouch Remote Oximetry Notification System*, paragraph 5.5. The transmitter batteries should be replaced every 24 months.

2.3.2 Pager

Refer to the Intouch remote oximetry notification system operator's manual for battery replacement procedures. The most recent copy of the operator's manual is available on the Internet at:

http://www.mallinckrodt.com/respiratory/resp/Serv_Supp/ProductManuals.html

2.3.3 Programmer

Refer to the Intouch remote oximetry notification system operator's manual for battery charging and replacement procedures.

SECTION 3: PERFORMANCE VERIFICATION

3.1 Introduction..... page 3-1
3.2 Equipment Needed..... page 3-1
3.3 Performance Verification page 3-1
3.4 Safety Tests page 3-3

3.1 INTRODUCTION

Caution: Whenever an Intouch remote oximetry notification system transmitter is moved, perform the performance verification procedures in paragraph 3.3 to ensure there are no interference problems. Whenever transmitting equipment is installed near an Intouch remote oximetry notification system transmitter, perform the performance verification procedures in paragraph 3.3 while the other transmitter is transmitting to ensure there are no interference problems.

This section discusses the tests used to verify performance following repairs or during routine maintenance. All tests can be performed without disassembling the units of the Intouch remote oximetry notification system. All tests must be performed as the last operation before the Intouch remote oximetry notification system is returned to use.

If the Intouch remote oximetry notification system fails to perform as specified in any test, repairs must be made to correct the problem before the Intouch remote oximetry notification system is returned to use.

3.2 EQUIPMENT NEEDED

Equipment	Description
Safety Analyzer	Must meet CAN/CSA C22.2 No. 60601.1, and UL 2601-1 specifications. Bio-Tek Instruments, Inc. or compatible.

3.3 PERFORMANCE TESTS

3.3.1 Intouch Transmitter Communicating with Monitor

This procedure verifies that the Intouch transmitter is communicating with the patient monitoring equipment (NPB-290, NPB-295, N-395, and N-595¹) and the applicable pager(s).

¹ The N-595 must have software version 2.4.6 or lower to work with the Intouch system.

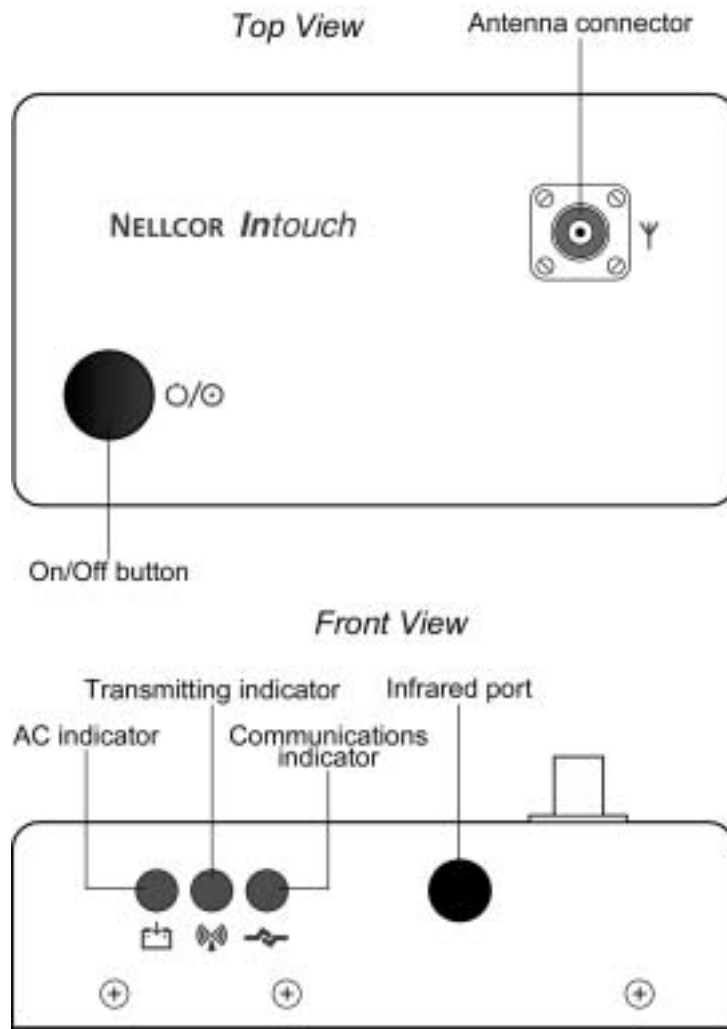

Figure 3-1: Intouch Transmitter

1. Connect the monitor to AC power and turn on the monitor.

Caution: The antenna must be connected to the transmitter before the transmitter is turned on. Turning on the transmitter without the antenna connected may damage the transmitter.

2. Connect the transmitter power supply cable to the transmitter.
3. Connect the transmitter power supply AC power cable to the power supply and to AC power.
4. Connect the transmitter to the monitor with the applicable interface cable.
5. Press On/Off button to turn on the transmitter.
6. The Communications indicator will be amber while the transmitter is turned on, but not communicating with the NPB-290, NPB-295, N-395, or N-595¹ oximeter.

¹ The N-595 must have software version 2.4.6 or lower to work with the Intouch system.

7. The Communications indicator turns green when communication is established with the monitor.
8. The transmitter will transmit a page to the associated pager(s) when communication is established. See Figure 3-2.

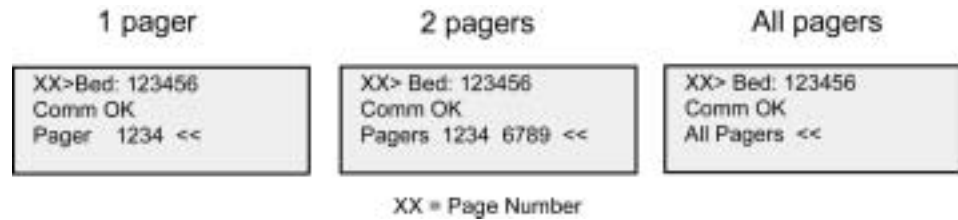

Figure 3-2: Communication OK Page

3.3.2 Test Page

This procedure verifies that the transmitter is communicating with the monitor and the applicable pager(s). This procedure also verifies that patient data is being transmitted.

1. Complete Intouch Transmitter Communicating with Monitor in paragraph 3.3.1.
2. Press transmitter On/Off button. See Figure 3-1.
3. The transmitter should transmit a test page to the assigned pager(s). See Figure 3-3.

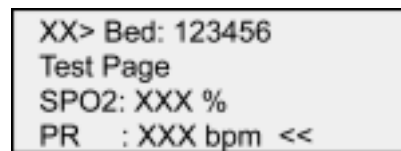

Figure 3-3: Test Page

Note: Refer to the Intouch operator's manual for a complete description of alarm notification messages. The most recent copy of the operator's manual is available on the Internet at:

http://www.mallinckrodt.com/respiratory/resp/Serv_Supp/ProductManuals.html

3.4 SAFETY TEST

Intouch safety tests meet the standards of, and are performed in accordance with, CAN/CSA-C22.2 No. 601.1 and UL 2601-1, Medical Electrical Equipment – Part 1: General Requirements for Safety, for instruments classified as Class 1 and Type "Not Classified."

3.4.1 Ground Integrity

Caution: Do not perform a ground integrity test. Disable the ground integrity test on your automatic tester. The ground integrity test is not required for the Intouch system and may damage the equipment.

3.4.2 Enclosure Leakage Current

This test is in compliance with UL 2601-1 (earth leakage current). The applied voltage for UL 2601-1, CSA 601.1, and UL 2601-1 is 120 volts AC, 60 Hz. All measurements shall be made with the power both "On" and "Off".

1. Connect the Intouch transmitter power supply AC plug to the electrical analyzer as recommended by the analyzer operating instructions.
2. Connect the Intouch transmitter power supply DC plug to the Intouch transmitter DC input connector.
3. The equipotential terminal on the analyzer is not connected to any metal on the Intouch transmitter.
4. The analyzer leakage indication must not exceed the values listed in Table 3-1.

Table 3-1: Enclosure Leakage Current Limits

AC Polarity	Neutral Wire (L2)	Leakage Current
Normal	Closed	300 μ A
Reversed	Closed	300 μ A
* Reversed	Open	1000 μ A
Normal	Open	1000 μ A
* = With AC polarity reversed and neutral wire (L2) open, the line wire (L1) is actually open		

SECTION 4: INSTALLATION

- 4.1 Introduction..... page 4-1
- 4.2 Intouch Transmitter Installation page 4-1
- 4.3 Turning On the Intouch Transmitter page 4-5
- 4.4 Pager and Bed Number Assignments..... page 4-7
- 4.5 Testing Transmitter Range..... page 4-13

4.1 INTRODUCTION

This section discusses how to configure the components of the Intouch remote oximetry notification system.

Caution: When connecting the Intouch remote oximetry notification system to any monitor, verify proper operation before clinical use. Both the Intouch remote oximetry notification system transmitter and the monitor connected to it must be connected to a grounded outlet. Accessory equipment connected to the monitor’s data interface must be certified according to IEC Standard 950 for data-processing equipment or IEC Standard 60601-1 for electromedical equipment. All combinations of equipment must be in compliance with IEC Standard 60601-1-1 systems requirements. Anyone who connects additional equipment to the oximeter signal input port or signal output port configures a medical system and is therefore responsible that the system complies with the requirements of system standard IEC Standard 60601-1-1 and the electromagnetic compatibility system standard IEC Standard 60601-1-2.

Caution: Whenever an Intouch remote oximetry notification system transmitter is moved, perform the performance verification procedures in paragraph 3.3 to ensure there are no interference problems. Whenever transmitting equipment is installed near an Intouch remote oximetry notification system transmitter, perform the performance verification procedures in paragraph 3.3 while the other transmitter is transmitting to ensure there are no interference problems.

4.2 INTOUCH TRANSMITTER INSTALLATION

To minimize the likelihood of the transmitter creating interference with the monitor, place the transmitter on top of the monitor towards the rear. For best results with the N-395 and N-595¹, place the transmitter on top of the monitor towards the right rear.

WARNING: In the USA, do not connect the Intouch transmitter to an electrical outlet controlled by a wall switch because the AC power may be accidentally turned off.

WARNING: To ensure patient safety, do not place the Intouch transmitter in any position that might cause it to fall on the patient.

WARNING: Do not lift the monitor by the sensor cable or power cord because the cable or cord could disconnect from the monitor, causing the monitor to drop on the patient.

¹ The N-595 must have software version 2.4.6 or lower to work with the Intouch system.

Caution: The antenna must be connected to the transmitter before the transmitter is turned on. Turning on the transmitter without the antenna connected may damage the transmitter.

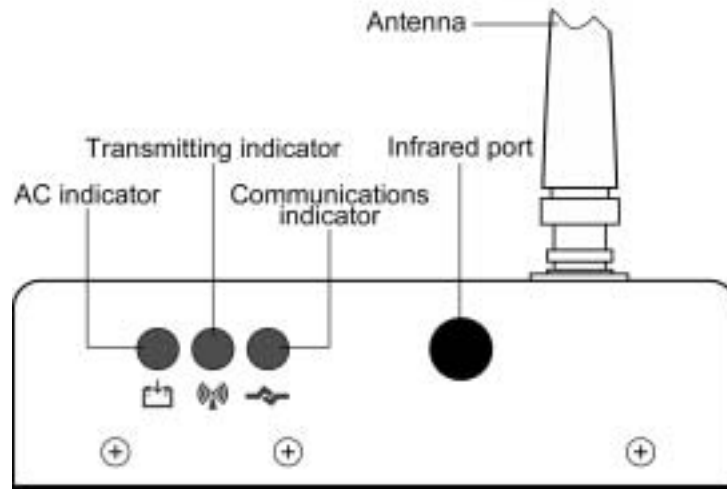

Figure 4-1: Intouch Transmitter Front View

1. Connect antenna to transmitter. See Figure 4-1.
2. Place transmitter on top of the NPB-290, NPB-295, N-395, or N-595¹ pulse oximeter. See Figure 4-3, Transmitter placement.

Note: To minimize the likelihood of the transmitter creating interference with the monitor, place the transmitter at the rear of the monitor. For best results with the N-395 or N-595¹ monitor, place the transmitter at the right rear of the monitor, as indicated in Figure 4-3.

¹ The N-595 must have software version 2.4.6 or lower to work with the Intouch system.

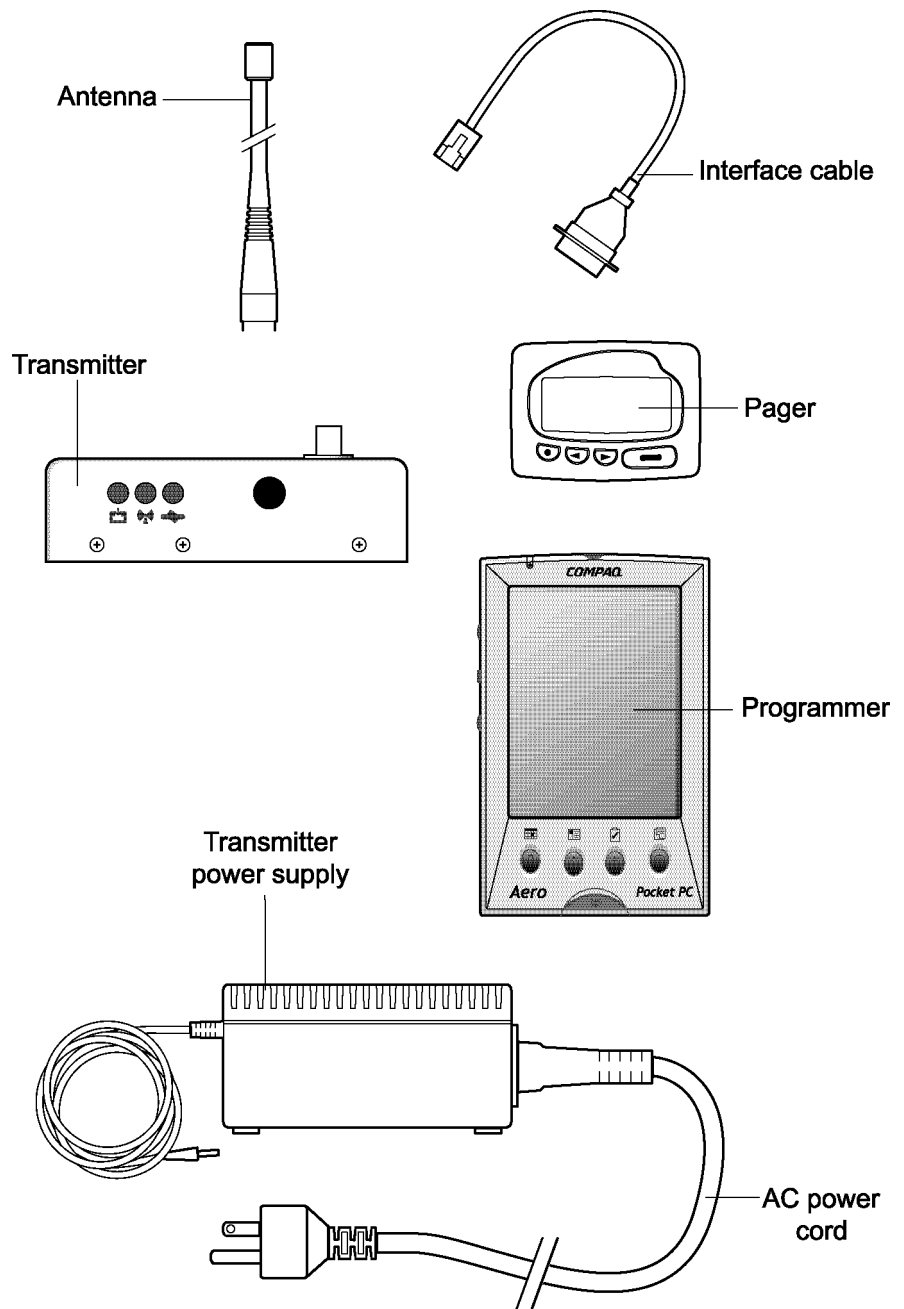

Figure 4-2: Intouch Components

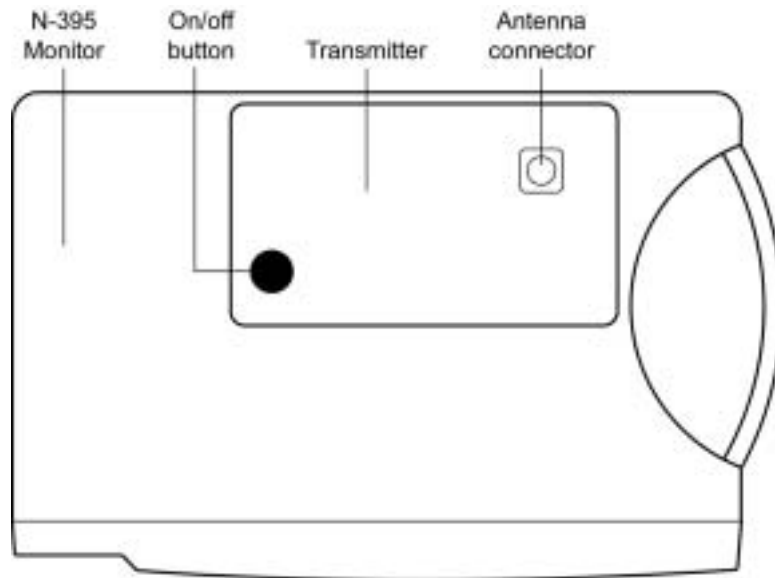

Figure 4-3: Transmitter Placement – N-395/595

3. Connect Intouch transmitter power supply to AC outlet.

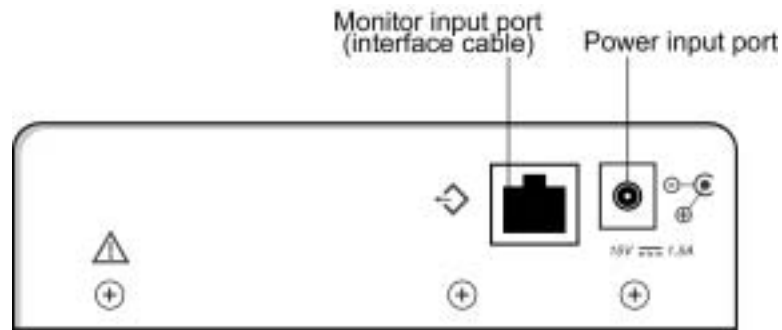

Figure 4-4: Transmitter Rear View

4. Connect Intouch power supply cable to Intouch transmitter power input port. See Figure 4-4.
5. Connect interface cable to the monitor input port of the Intouch transmitter.
6. Connect interface cable to NPB-290, NPB-295, N-395, or N-595¹ pulse oximeter. Refer to applicable pulse oximeter operator's or service manual. The most recent copy of the operator's manual is available on the Internet at: http://www.mallinckrodt.com/respiratory/resp/Serv_Supp/ProductManuals.html
7. Configure the pulse oximeter data port to ASCII mode at a baud rate of 9600. Refer to applicable pulse oximeter operator's manual.
8. Ensure that the monitor is operating on AC power.

¹ The N-595 must have software version 2.4.6 or lower to work with the Intouch system.

WARNING: NPB-290 and NPB-295 monitors must be connected to AC power to communicate with the transmitter. The monitor's data port is disabled when it is operating on battery power. Monitor alarms cannot be transmitted while the monitor is operating on battery power.

WARNING: N-395 and N-595¹ monitors should always be connected to AC power when used with an Intouch transmitter. Operating a monitor on battery power is not recommended due to limited battery life; moreover, if a monitored, mobile patient leaves the Intouch designated coverage area, the pager might not receive an alarm.

4.3 TURNING ON THE INTOUCH TRANSMITTER

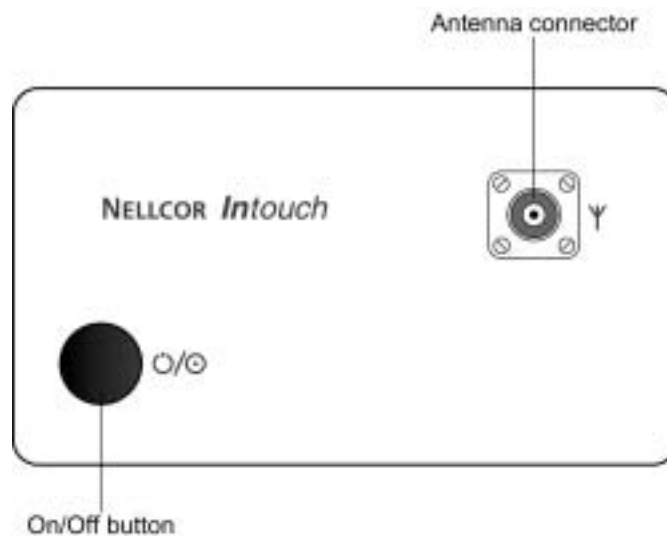

Figure 4-5: Transmitter Top View

Caution: The antenna must be connected to the transmitter before the transmitter is turned on. Turning on the transmitter without the antenna connected may damage the transmitter.

1. Press transmitter On/Off button. See Figure 4-5.
2. Transmitter performs Power-On Self-Test (POST). See Figure 4-6 and Table 4-1.

¹ The N-595 must have software version 2.4.6 or lower to work with the Intouch system.

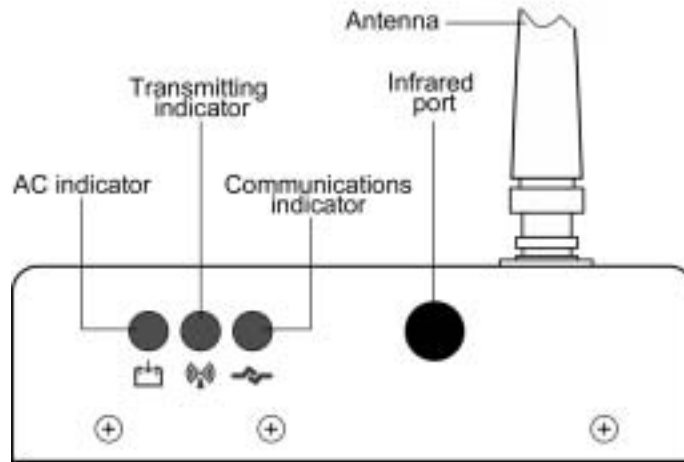

Figure 4-6: Transmitter Front View

Table 4-1: POST Light Sequence

Stage	Stage Indication	Test	Failure Indication
1	Green Transmitter LED	Transmitter program flash memory check	Simultaneously flashing Transmitter and Communications LED's
2	Green Communications LED	External SRAM	Simultaneously flashing Transmitter and Communications LED's
3	Amber Transmitter LED	Operation of the IrDA UART	Simultaneously flashing Transmitter and Communications LED's
4	Amber Communications LED	RF board synch lock	Alternately flashing Transmitter ¹ , Communications ¹
5	Amber Communications LED	Transmitter ID flash read	Alternately flashing Transmitter ² , Communications ²
6	Amber Communications LED	Setup flash read	Alternately flashing Transmitter ³ , Communications ³

Table 4-1: POST Light Sequence**Notes:**

1. Flashing rate is approximately 2.2 Hz.
2. Flashing color is amber.
3. If the transmitter has just been reprogrammed and a Stage 6 Failure occurs, the transmitter will attempt to recover, by reverting to the default setup values and writing these to flash memory. To alert the installer that the transmitter has reverted to the default values and will need to be reprogrammed with the appropriate system parameters, the transmitter will start to flash its Transmitter and Communications LEDs. If the transmitter is turned off and on again, and now seems to function properly, the transmitter will have been reset to the default values and needs to be reprogrammed with the appropriate frequency, baud rate, and global cap code as well as any other user setup.
Otherwise, it is an indication of a hardware failure, even if the transmitter seems to recover.

3. After POST is complete, the transmitter will transmit a Comm OK page. See Figure 4-7.

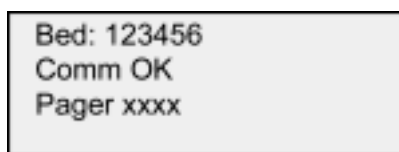
**Figure 4-7: Test Page****4.4 PAGER AND BED NUMBER ASSIGNMENTS**

During initial installation, each transmitter is programmed with its assigned bed number assigned and 1, 2, or all pagers assigned. These assignments will change as transmitters are moved to different beds, as the transmitters are moved around the facility, as pagers are changed, or as pager assignments and requirements are changed.

Note: You should become familiar with the operation of the programmer before completing these procedures. Refer to the Intouch operator's manual. You will be required to enter/change data in the programmer during these procedures. The most recent copy of the operator's manual is available on the Internet at: http://www.mallinckrodt.com/respiratory/resp/Serv_Supp/ProductManuals.html

The programmer is used to program the Intouch transmitters. The programmer is configured for your specific site during initial installation.

4.4.1 Determining the Current Transmitter Settings

This procedure allows you to determine the current transmitter settings.

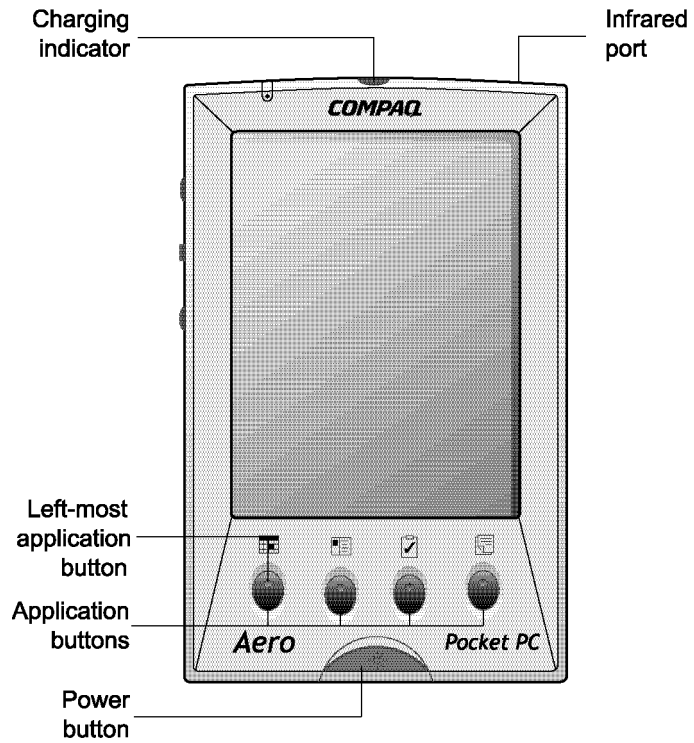



Figure 4-8: Programmer

1. Click the programmer Power button. See Figure 4-8.

Note: The programmer will display the screen that was in use when it was turned off. If necessary, click the Exit button  or press the left-most application button to return to the 3-button screen.

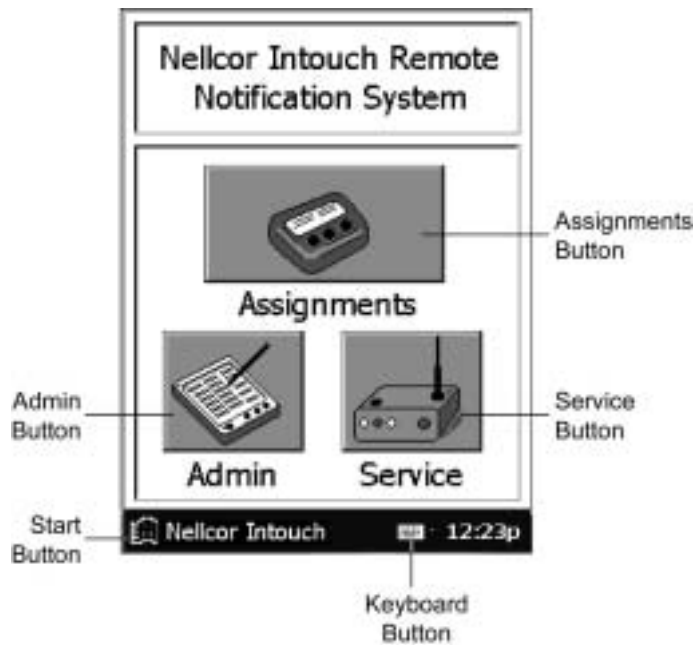

Figure 4-9: 3-button Screen

- Click the Assignments button. The Assignment Program Main Screen will appear. See Figure 4-10.

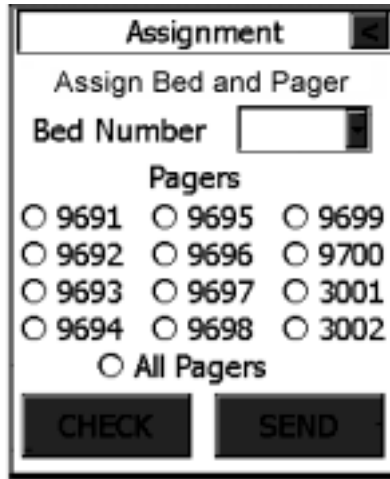

Figure 4-10: Assignment Program Main Screen

This program is used to view, set, or change the transmitter's setup of bed numbers and cap codes.

Note: When communicating between the programmer and the Intouch transmitter, the IR ports of the two units must be aligned. The IR ports must be within 4 feet (1.2 meters) of each other. This position must be maintained during communications between units.

- Hold the programmer with the IR port pointing at the transmitter IR port and click the Check button.

Note: Error Messages: When there is a communications problem between the programmer and the transmitter, an error message or an advisory message will appear. Refer to paragraph 5.9, page 5-6.

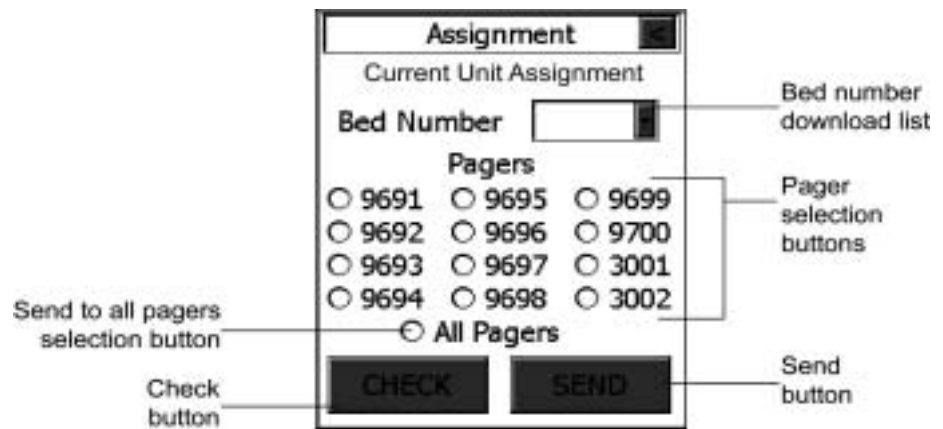

Figure 4-11: Transmitter Data Loaded

4.4.2 Changing Bed Numbers or Pager Assignments

Bed numbers are usually assigned by the location of the room in the care unit. As a transmitter is moved around the care unit, the bed number should be changed to identify the location of the room. Pagers are assigned to medical personnel responsible for the patient and are identified by their Cap Codes. Pagers must be separated from each other by four or more inches to eliminate interference between pagers.

Note: Cap codes are 7-digit numbers unique to a specific pager. A pager's cap code corresponds to the last six digits of the pager's serial number (located on the back of the pager) plus a zero in front. For example, if a pager's serial number is 019691, its cap code is 0019691.

1. Retrieve the transmitter settings by completing procedure 4.4.1, page 4-7.
2. Select patient bed number. Click "Bed Number" download list and click applicable bed number. See Figure 4-11.

Note: One, two, or all pagers may be selected for each bed.

3. Selecting one or two pagers - Click the applicable Pager Selection button or buttons. These Pager Selection button numbers represent the last four digits of the pager serial number.
4. Selecting all pagers - Click the All Pagers Selection button.
5. Hold the programmer with the IR port pointing at the transmitter IR port and click the Send button to program the transmitter with the newly selected values.

Note: Error Messages: When there is a communications problem between the programmer and the transmitter, an error message or an advisory message will appear. Refer to paragraph 5.9, page 5-6.

6. When transmitter programming is complete, the programmer will display a Programming Successful status. See Figure 4-12.
7. A "Confirmation" page will also be sent to the newly selected pager(s), displaying the newly selected bed number.

Note: If the "Confirmation" page was not sent, transmitter programming was not successful. Receiving the "Confirmation" page is confirmation of successful transmitter programming.

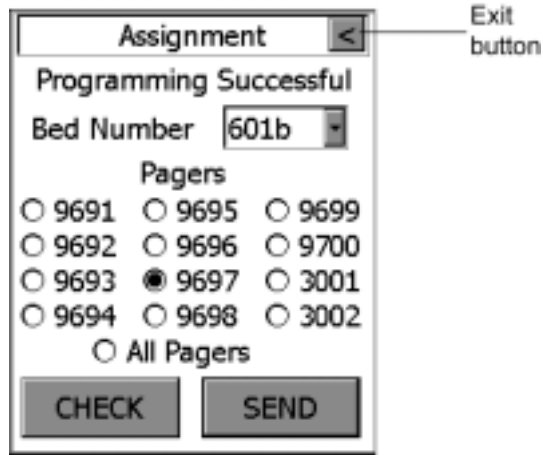

Figure 4-12: Programming Successful

8. Repeat this procedure for each bed in your system. Ensure that the "Confirmation" page is sent for each transmitter.

4.4.3 Setting Delay Time for Reminder Page

The reminder page is transmitted whenever an alarm page is sent and the alarm is not silenced at the monitor within a preset time. This procedure allows you to set the time between the alarm and the sending of a reminder page.

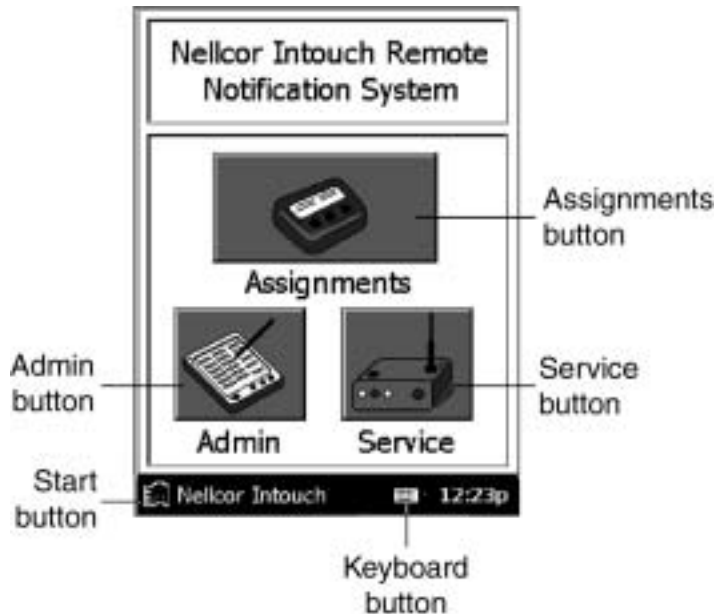

Figure 4-13: Start Button

1. Click the programmer Power button.

Note: The programmer will display the screen that was in use when it was last turned off. Click the Exit button  or press the left-most application button to return to the 3-button screen.



Figure 4-14: Transmitter Program Main Screen

Note: Error Messages: When there is a communications problem between the programmer and the transmitter, an error message or an advisory message will appear. Refer to paragraph 5.9, page 5-6.

2. Click the Service button to display the Controls page of the transmitter's setup information.
3. Point the programmer IR port at the transmitter IR port and click the Check button to obtain the current configuration programmed into the transmitter. See Figure 4-14.
4. To set the Send the Reminder page delay, click the Down arrow. See Figure 4-15.

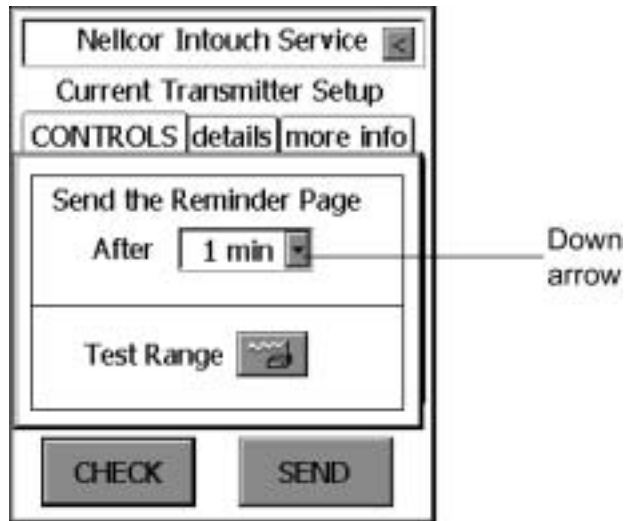

Figure 4-15: Transmitter Program Main Screen

5. Click the reminder time you wish to store in the transmitter.

Note: The same reminder time should be used for all transmitters within the care unit Intouch system. If your facility has more than one Intouch system, the

reminder time should be the same for all transmitters within a system. The reminder time between two or more Intouch systems may vary with each system.

Note: When the reminder time is changed on the programmer, it will change the reminder time on all subsequent transmitters as they are programmed.

6. Point the programmer IR port at the transmitter IR port and click the Send button to update the "Send Reminder Page After" delay in the current configuration program in the transmitter.
7. The Service Program screen will display "Sending Program Data" if communication is established.
8. When transmitter programming is complete, the Service Program screen will display "Programming Successful." See Figure 4-16.



Figure 4-16: Transmitter Programming Successful

9. A "Confirmation" page will also be sent to the newly selected pager(s), displaying the newly selected bed number.

Note: If the "Confirmation" page was not sent, transmitter programming was not successful.

4.5 TESTING TRANSMITTER RANGE

The Test Range Mode is a mode in which frequent periodic pages are sent from the Intouch transmitter to the assigned pager(s). This mode can be used to determine the area of coverage of your system. While in the Test Range Mode, someone should walk around the care unit with a pager ensuring that all pages are received. This procedure should be performed using the two transmitters that are farthest apart. You should determine that all pages are received and that the two transmitters are detecting each other.

When the transmitters are detecting each other. The transmitter Transmitting Indicator will be green when the transmitter is transmitting the survey and will remain lit for approximately 1 second. The transmitter Transmitting Indicator will

turn amber when the transmitter detects another transmitter transmitting on the same frequency.

The time between pages and the number of pages to be sent are determined during initial installation. Refer to paragraph 6.3.7, page 6-11.

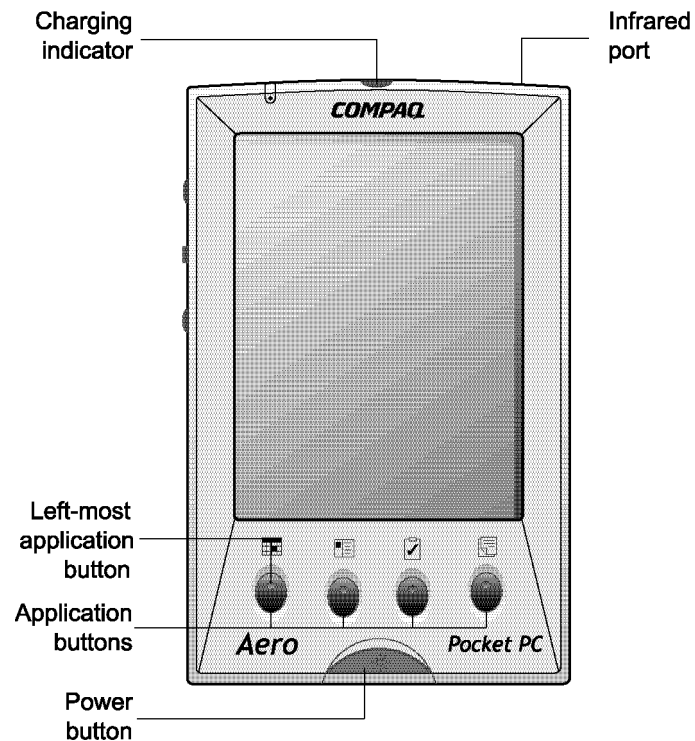



Figure 4-17: Programmer On/Off Button

1. Click the programmer Power button. See Figure 4-17.

Note: The programmer will display the screen that was in use when it was turned off. Click the Exit button  or press the left-most application button to return to the 3-button screen.

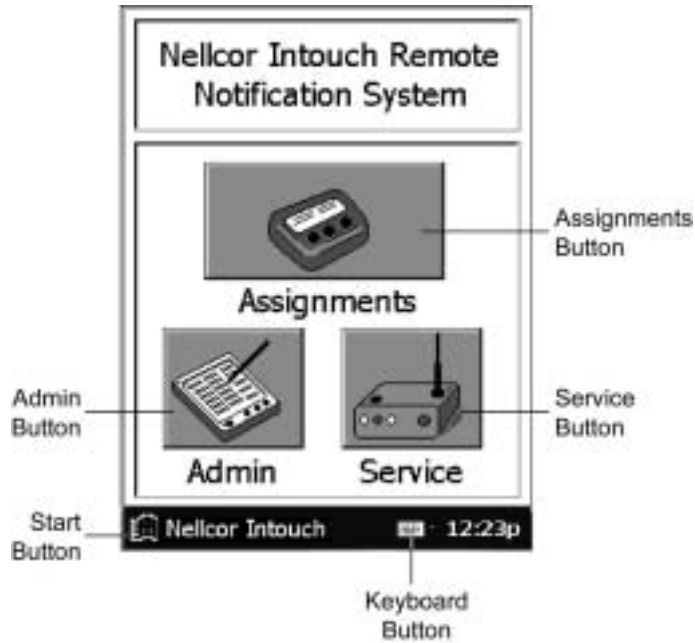

Figure 4-18: 3-button Screen

2. Click the Service button (Figure 4-18). The Service Program main screen will be displayed. See Figure 4-19.

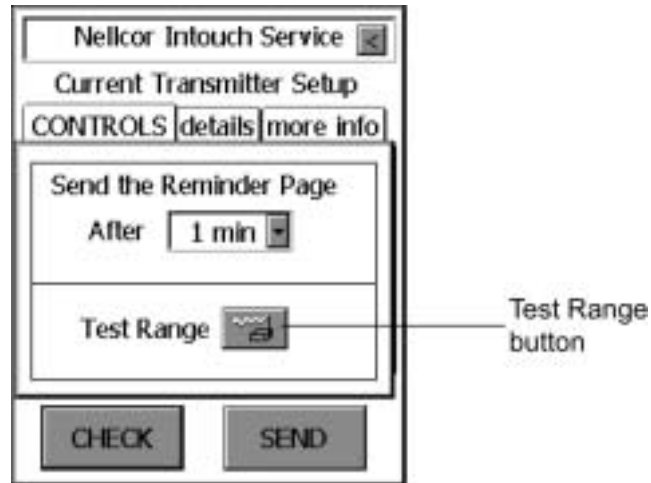

Figure 4-19: Transmitter Program Main Screen

Note: When initiating a range study (survey page), the transmitter cannot be actively communicating with the patient monitor.

3. Point the programmer IR port at the transmitter IR port and click the Test Range button.

Note: The transmitter will transmit numbered survey pages. Momentarily click the transmitter ON/OFF button to stop the transmitter from sending survey pages.

4. Ensure that the appropriate pager is receiving the sequential pages (Figure 4-20) as you walk around your care unit with the appropriate pager. This will identify any areas of no reception in your coverage area. Check for missing page numbers as an indication of areas of no reception or out-of-range conditions.

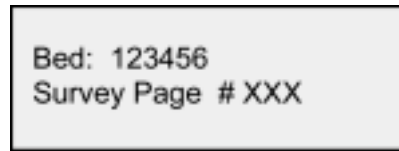

Figure 4-20: Survey Page Display

5. Repeat this procedure as required to cover your entire care unit.

If areas of no or incomplete reception are identified and they present a problem to the functioning of your facility, contact Nellcor's Technical Services Department or your local Nellcor representative.
6. Turn off the programmer.
7. Inform clinical staff of any known areas of no or incomplete reception.
8. Turn off transmitter.

SECTION 5: TROUBLESHOOTING

- 5.1 Introduction..... page 5-1
- 5.2 How to Use this Section page 5-1
- 5.3 Who Should Perform Repairs page 5-1
- 5.4 Replacement Level Supported..... page 5-1
- 5.5 Returning the Intouch Remote Oximetry Notification System..... page 5-1
- 5.6 Obtaining Replacement Parts page 5-2
- 5.7 Troubleshooting Guide page 5-2
- 5.8 Restoring the Intouch Software on the Compaq Programmer..... page 5-2
- 5.9 Error Codes page 5-6
- 5.10 EMI (Electromagnetic Interference) page 5-7

5.1 INTRODUCTION

Caution: Whenever an Intouch remote oximetry notification system transmitter is moved, perform the performance verification procedures in paragraph 3.3 to ensure there are no interference problems. Whenever transmitting equipment is installed near an Intouch remote oximetry notification system transmitter, perform the performance verification procedures in paragraph 3.3 while the other transmitter is transmitting to ensure there are no interference problems.

This section explains how to troubleshoot the Intouch remote oximetry notification system if problems arise. Tables are supplied that list possible Intouch remote oximetry notification system difficulties, along with probable causes, and recommended actions to correct the difficulty.

5.2 HOW TO USE THIS SECTION

Use this section in conjunction with [Section 3, Performance Verification](#), and [Section 7, Spare Parts](#).

5.3 WHO SHOULD PERFORM REPAIRS

The Intouch remote oximetry notification system transmitter, programmer, and pager should be returned to Nellcor Technical Services for repair.

5.4 REPLACEMENT LEVEL SUPPORTED

The replacement level supported for this product is to the transmitter, programmer, and pager level. Refer to the next paragraph for returning a transmitter, programmer, or pager.

5.5 RETURNING THE INTOUCH REMOTE OXIMETRY NOTIFICATION SYSTEM

Contact Nellcor Technical Services Department or your local Nellcor representative for shipping instructions including a Returned Goods Authorization (RGA) number. Pack the Intouch remote oximetry notification system transmitter, programmer, or pager in its original shipping carton. If the original carton is not available, use a suitable carton with appropriate packing material to protect it during shipping. Refer to [Section 8, Packing for Shipment](#) for packing instructions.

Return the Intouch remote oximetry notification system by any shipping method that provides proof of delivery.

5.6 OBTAINING REPLACEMENT PARTS

Nellcor's Technical Services provides technical assistance information and replacement parts. To obtain replacement parts, contact Nellcor or your local Nellcor representative. Refer to parts by the part names listed in [Section 7, Spare Parts](#).

5.7 TROUBLESHOOTING GUIDE

Problems with the Intouch transmitter detected during power-on self-test (POST) are documented in Table 4-1, page 4-6.

Problems with the Intouch remote oximetry notification system are categorized in Table 5-1 and Table 5-2.

Note: Taking the recommended corrective actions discussed in this section will correct the majority of problems you may encounter. However, problems not covered here can be resolved by calling Nellcor Technical Services Department or your local Nellcor representative.

5.8 RESTORING THE INTOUCH SOFTWARE ON THE COMPAQ PROGRAMMER

If both the main and the backup batteries of the Compaq programmer have become depleted or have been removed simultaneously, the Intouch software may not appear when both batteries are reinstalled.

The Compaq programmer contains a Flash card located on the top edge of the programmer that allows you to reinstall the Intouch software if it should inadvertently become uninstalled. If your flash card is not already installed, use the following procedure to install it.

1. Remove the Flash card slot cover by placing your thumbnail against the cover indentation on the rear of the programmer and sliding it out.



Figure 5-1: Removing the Flash Card Slot Cover

2. Insert the Flash card into the slot, label side up.



Figure 5-2: Inserting the Flash Card

3. Slide the flash card into the slot until it docks with the connector inside the slot.

Use the following procedure to restore the Intouch program:



1. If the programmer is not already on, click the Power button to turn it on.



2. Click the Q button on the side of the programmer.
3. Select “QUtilities.” (Your menu may look somewhat different than the one illustrated below.)



4. Click on the CF Backup tab.

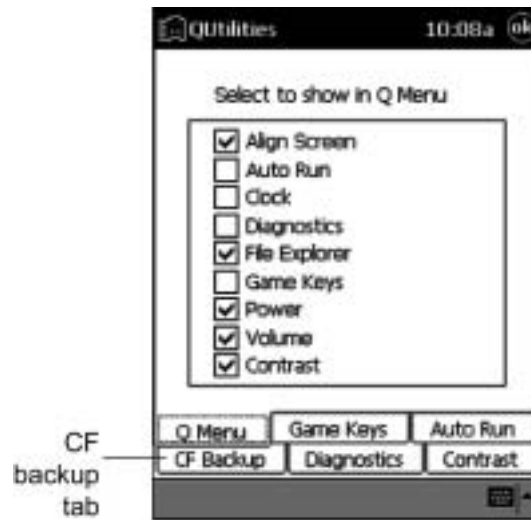

-  5. Click on the Restore button to access the restore program.

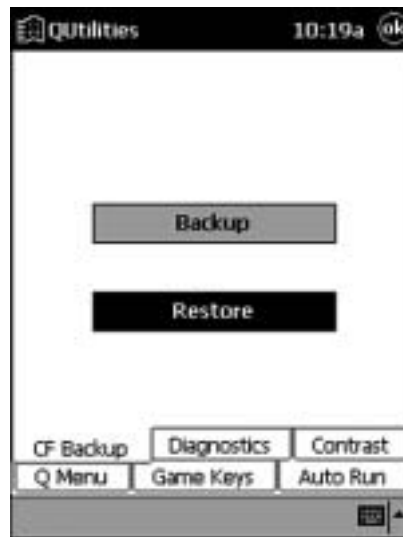

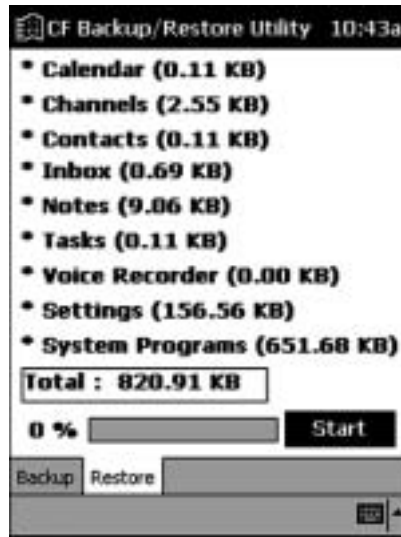

-  6. Click on the Start button to initiate the restore process.

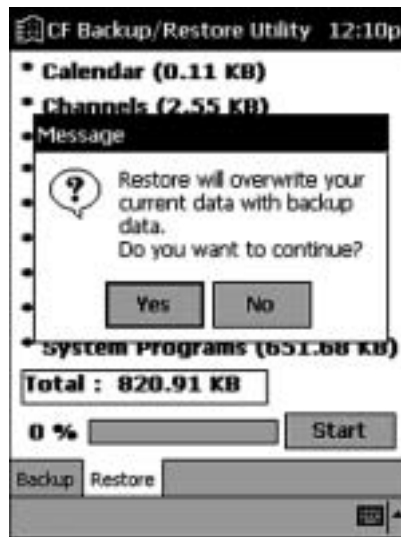

7. A message asks you if you are sure you want to continue. Click Yes.



8.  A warning box appears, reminding you not to try to use the device or remove the flash card while the programmer is being restored. Click on “OK.”
9.  A status bar reporting the activity until the function is complete (the status bar may stay on 99% for several minutes). When the process is complete, a message appears telling you to click the Reset button to resume operation. Click on “OK” and press the Reset button on the back of the programmer
10. Click the Left-most application button to display the Intouch 3-button screen.



5.9 ERROR MESSAGES

If possible, the Intouch transmitter will send error messages to the pager(s) when errors occur. Refer to Table 5-1 for transmitter error messages and Table 5-2 for programmer error messages.

Table 5-1: Transmitter Error Messages

Error Message	Possible Cause	Corrective Action
<i>Comm Fail Retrying</i>	<ol style="list-style-type: none"> 1. Communications between transmitter and pulse oximeter monitor has failed. 2. Monitor operating on battery power. 3. Monitor turned off but Intouch transmitter is on. 	<ol style="list-style-type: none"> 1. Check serial cable and cable connections between transmitter and monitor. Replace or reconnect cable as required. 2. Connect monitor to AC power. 3. Check monitor performance. Refer to NPB-290, NPB-295, N-395, or N-595¹ service manual. 4. Turn on transmitter.
<i>Comm Fail Tx Shut Down Or Low TX Battery Tx Shut Down</i>	One hour has passed since communications between transmitter and pulse oximeter monitor failed or the battery is too low for normal operation, the transmitter is shutting down.	<ol style="list-style-type: none"> 1. Check serial cable and cable connections between transmitter and monitor. Replace or reconnect cable as required. 2. Check monitor performance. Refer to NPB-290, NPB-295, N-395, or N-595¹ service manual. 3. Connect transmitter to AC power. 4. Ensure monitor is operating on AC power.
<i>Low TX Battery Connect AC Power To Transmitter</i>	Transmitter battery is low.	<ol style="list-style-type: none"> 1. Connect transmitter to AC power. Refer to operator's manual. 2. Recharge battery. 3. Return unit to Nellcor's Technical Services Department for battery replacement.

¹ The N-595 must have software version 2.4.6 or lower to work with the Intouch system.

Table 5-2: Programmer Error Messages

Failed to Connect	<ol style="list-style-type: none"> 1. Programmer IR port not aligned with transmitter IR port. 2. Transmitter turned off. 3. Transmitter defective. 4. Programmer defective. 5. Programmer batteries are low. 	<ol style="list-style-type: none"> 1. Move programmer IR port into alignment with transmitter IR port. 2. Turn on transmitter. 3. Replace transmitter. 4. Replace programmer. 5. Replace or recharge programmer batteries.
Please be sure the transmitter is turned on, the IR port is pointed directly at the transmitter, at a distance less than 4 ft (1.2 m), and try again.	<ol style="list-style-type: none"> 1. Programmer IR port not aligned with transmitter IR port. 2. Programmer batteries are low. 3. Transmitter is not turned on. 	<ol style="list-style-type: none"> 1. Move programmer IR port into alignment with transmitter IR port. 2. Replace or recharge programmer batteries. 3. Turn on transmitter.
Programming Failed	<ol style="list-style-type: none"> 1. Ambient light noises. 2. Transmitter defective. 3. Programmer defective. 4. Programmer batteries are low. 	<ol style="list-style-type: none"> 1. Try programming again. 2. Replace transmitter. 3. Replace programmer. 4. Replace or recharge programmer batteries. 5. No error if "Programming OK" page is received by pager.
Unable To Access Port Probably In Use	<ol style="list-style-type: none"> 1. Programmer error. 2. Programmer defective. 	<ol style="list-style-type: none"> 1. Reboot the programmer. Refer to operator's manual. 2. Replace programmer.
You must select or get a bed number and one or more pagers	Programmer "Program" button was clicked before selecting a bed number or pagers.	Redo procedure, paragraph 4.4.2, page 4-10.

5.10 EMI (ELECTROMAGNETIC INTERFERENCE)

Caution: This device has been tested and found to comply with the limits for medical devices to the IEC 60601-1-2:1993, EN 60601-1-2:1994, Medical Device Directive 93/42/EEC. These limits are designed to provide reasonable protection against harmful interference in a typical medical installation.

However, because of the proliferation of radio-frequency transmitting equipment and other sources of electrical noise in healthcare environments (for

example, electrosurgical units, cellular phones, mobile two-way radios, electrical appliances, and high-definition television), it is possible that high levels of such interference due to close proximity or strength of a source, may result in disruption of performance of this device.

The NPB-290, NPB-295, N-395, and N-595¹ are not designed for use in environments in which the pulse can be obscured by electromagnetic interference. During such interference, measurements may seem inappropriate or the monitor may not seem to operate correctly. The Intouch remote oximetry notification system may generate alarms or error messages during these conditions.

Erratic readings, cessation of operation, or other incorrect functioning may evidence disruption. If this occurs, the site of use should be surveyed to determine the source of this disruption, and the following actions taken to eliminate the source:

- Turn equipment in the vicinity off and on to isolate the offending equipment.
- Reorient or relocate the interfering equipment.
- Increase the separation between the interfering equipment and this equipment.

The following tasks may improve EMI problems. The Intouch remote oximetry notification system generates, uses, and can radiate radio frequency energy and, if not installed and used in accordance with these instructions, may cause harmful interference with other devices in the vicinity.

- Pagers must be separated from each other by at least 4 inches to eliminate interference between pagers.
- Manage (increase) distance between sources of EMI and susceptible devices
- Manage the use of frequencies close to the Intouch remote oximetry notification system frequencies
- Manage (remove) devices that are highly susceptible to EMI
- Lower power from internal sources under facility control (paging systems)
- Label devices susceptible to EMI
- Educate staff (nurses and doctors) to be aware of, and to recognize, potential EMI related problems
- Perform technical remedial action to eliminate EMI, such as shielding
- Share relevant EMI information with others, especially in evaluation of new equipment purchases which may have EMI
- Identify critical areas where lift-support devices are in use and restrict the use of personal communicators (cell phones, computers) in those critical areas

Use critical care devices that comply with IEC 60601-1-2 EMC Standards:

- The required level of EMI immunity is 3 volts per meter

¹ The N-595 must have software version 2.4.6 or lower to work with the Intouch system.

- The interference level that a medical device can radiate (emit) is 0.0014 volts per meter

If assistance is required, contact Nellcor Technical Services Department or your local Nellcor representative.

Use critical care equipment in the vicinity of the Intouch transmitter that complies with IEC 60601-1-2 EMC standards including

- EMI immunity of 3 volts per meter or better
- interference level no greater than 0.0014 volts per meter

The Intouch transmitter has a power level of up to .25 watts peak at a preselected RF frequency between 450 MHz to 466 MHz. Estimated EMI protection distance at a peak power of .25 watts (450 – 466 MHz) are:

Immunity level	Protected distance
1 volt/meter	1.8 meters (5.7 feet)
2 volts/meter	0.9 meters (2.9 feet)
3 volts/meter	0.6 meters (1.9 feet)

Blank Page

SECTION 6: SITE SURVEY AND INSTALLATION PROGRAM

6.1 Introduction..... page 6-1
6.2 Initial Installation Procedure page 6-2
6.2 Installation Program page 6-5

6.1 INTRODUCTION

Caution: When connecting the Intouch remote oximetry notification system to any monitor, verify proper operation before clinical use. Both the Intouch remote oximetry notification system transmitter and the monitor connected to it must be connected to a grounded outlet. Accessory equipment connected to the monitor’s data interface must be certified according to IEC Standard 950 for data-processing equipment or IEC Standard 60601-1 for electromedical equipment. All combinations of equipment must be in compliance with IEC Standard 60601-1-1 systems requirements. Anyone who connects additional equipment to the oximeter signal input port or signal output port configures a medical system and is therefore responsible that the system complies with the requirements of system standard IEC Standard 60601-1-1 and the electromagnetic compatibility system standard IEC Standard 60601-1-2.

Caution: Whenever the transmitter is moved, perform the performance verification procedures in paragraph 3.3 to ensure there are no interference problems. Whenever other transmitting equipment is installed near the Intouch transmitter, perform the performance verification procedures in paragraph 3.3 while the other transmitter is transmitting to ensure there are no interference problems.

The Intouch Install Program is a separate program started from the start menu on the bottom line of the programmer screen. Before programming, the user needs to retrieve the transmitter’s setup by clicking the Check button. Once this is done, the user may edit the displayed values and program several transmitters with the same setup. Clicking the Program button performs programming.

This procedure must be performed for each transmitter to be installed at the facility.

The Intouch Install program is intended for use by Nellcor’s Customer Services Engineer. The Intouch Install program is used to setup and view parameters that cannot be changed with the Intouch System Manager (SysMgr) program. The parameters that the Intouch Install program can change are:

- Program password
- Bed numbers (select only – not change)
- Alarms page destinations (selected pagers or all pagers)
- Default reminder page interval
- Transmission frequency
- Transmission baud rate
- Pager cap codes (select only – not change)
- Global Cap code
- Survey page interval
- Number of survey pages sent in a survey

6.2 INITIAL INSTALLATION PROCEDURE

This section describes the initial installation procedure for the Intouch remote oximetry notification system. This procedure should be completed by the installation team. The procedure assumes that a Nellcor Customer Service Engineer has performed a site survey to determine the frequencies to be used by this site.

6.2.1 Setup

1. Arrive on site.
2. Locate the care unit where the Intouch remote oximetry notification system is to be installed.
3. Determine the farthest limits of the care unit based on physical distances.

6.2.2 Frequency Verification

Frequency verification determines if there are any other rf activities in the area which could interfere with the Intouch system. This procedure uses the Intouch transmitter's carrier detect function.

1. Program the Intouch transmitters to the frequency assigned to the care unit (paragraph 6.3.6).
2. Verify that the pager baud rate in the Intouch transmitters is correct (paragraph 6.3.6).
3. Verify that the All pagers cap code in the Intouch transmitter is correct (paragraph 6.3.6).
4. Program the Intouch transmitters survey page mode for 150 pages and for 120 seconds between pages (paragraph 6.3.7).
5. Place Intouch transmitters throughout the care unit. Transmitters should be located at the distant extremes of the care unit.
6. Turn on all transmitters.
7. Complete a survey page operation for each transmitter within the care unit group (paragraph 6.3.9).



8. Observe the Transmitting Indicator LED.
 - This LED will be green when transmitting the survey page (approximately every 120 seconds) and will remain lit for approximately 2 seconds.
 - When the transmitter is in the survey mode, this LED will be amber when the transmitter detects another transmission on the transmitter frequency using carrier detect.
 - Be sure to account for any other Intouch transmitters that may be sending pages.
 - To verify that this is a usable frequency, this LED should remain dark except for those transmissions that can be accounted for.

6.2.3 Range Test

The range test verifies the coverage area of an individual Intouch transmitter. This procedure is used to determine if there are areas of poor or no reception. The procedure also verifies that the Intouch transmitters can detect each other's transmissions.

1. Place a transmitter in the farthest extent of the care unit.
2. Program the transmitter for survey mode to transmit every 10 seconds for 150 pages (paragraph 6.3.7).
3. Walk slowly around the care unit with an active pager to determine any areas of no reception. Pagers must be separated from each other by at least four inches to eliminate interference between pagers.
 - During the walk, observe the sequentially numbered survey pages from 1 up to a maximum of 150.
 - Locate any areas where one of the numbered pages is not received on the pager. That is an indication of an area of no reception.
 - If any suspected areas of no reception are found, walk slowly until the exact parameters of the areas of no reception are defined.
 - Walk into all rooms of the care unit.
 - A corrupt page, partial page, or incomplete page is the same as a missing page.
 - Pay attention to:
 - Elevator banks
 - Columns
 - Double doors
 - Metal doors
 - Plaster construction
4. Place another transmitter in the other end of the care unit from the one used in paragraph 6.2.3, step 1.
5. Make sure both transmitters are sending survey pages at 10-second intervals for 150 pages. Initiate survey page mode for both transmitters at the same time.
6. Verify that each transmitter can detect transmissions from the other transmitter.
 - When the first transmitter sends a survey page, the second transmitter's Transmitting Indicator LED will be amber if the second transmitter detects the first transmitter's transmission. This should be seen at 10-second intervals.
 - An easy way to verify that the amber LED is from a valid transmitter is to use a pager. Compare the receipt of a page from the first transmitter with the amber LED on the second transmitter. These should correspond in time although they may not be exactly simultaneous.
 - An amber LED that does not correspond to a survey page from the first transmitter may indicate interference.

- If the second transmitter does not detect the first transmitter's pages, the test fails. It is possible for the pager to receive the page but the second transmitter does not detect the page from the first transmitter. This is still a failure.
7. If no areas of no reception are discovered and the transmitters can detect each other's transmissions, the range test is complete.
 8. If the extents of the coverage exceed the care unit, only claim the care unit's physical limits.
 9. Communicate the extents of tested coverage and detected areas of no reception to the clinical staff both verbally and in written form.

6.2.4 Programmer Set Up

1. Make a list of all patient beds in the care unit.
2. Verify with the charge nurse that the list is representative of how the clinical staff reference the bed numbers. For example, in a semi-private room with two beds, do they reference the beds as Room 501 A and 501 B, or Room 501-1 and 501-2?
3. Enter the entire list of beds, up to 48 beds, in the Intouch programmer. Refer to the paragraph Viewing or Editing the List of Bed Numbers, in the Intouch operator's manual. The most recent copy of the operator's manual is available on the Internet at: http://www.mallinckrodt.com/respiratory/resp/Serv_Supp/ProductManuals.html
4. Enter the cap codes of all the pagers to be installed in the care unit, up to 12 pagers, into the Intouch programmer. Refer to paragraph Viewing or Changing the List of Pager Numbers and Cap Codes, in the Intouch operator's manual.
5. Set the reminder page time interval in accordance with the care unit's policy (paragraph 6.3.5).
6. Program all Intouch transmitters assigned to the care unit with these parameters (paragraph 6.3.8).

6.2.5 Final Setup

1. Connect each Intouch transmitter to AC power for 17 hours to ensure the batteries are fully charged before placing the Intouch transmitters into service.
2. Charge the Compaq programmer by connecting its AC adapter to the programmer and AC power. The charging indicator on top of the programmer blinks while the battery is charging. When the battery is fully charged, the battery remains on but stops blinking. A full charge of a completely discharged battery takes approximately 3 hours.

6.3 INTOUCH INSTALL PROGRAM

6.3.1 Entering the Intouch Install Program

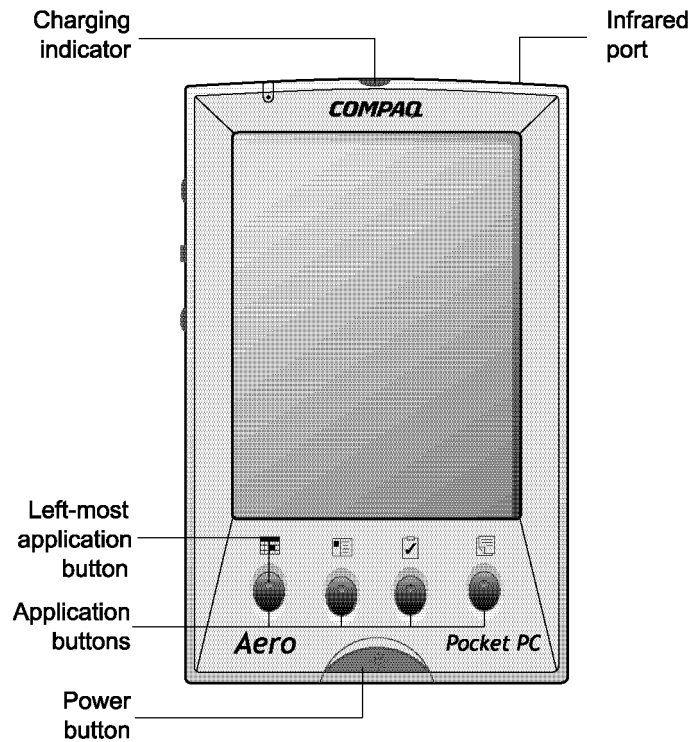

Figure 6-1: Programmer Power Switch

1. Click the programmer Power button. See Figure 6-1.

Note: The programmer will display the screen that was in use when it was turned off. Click the left-most application button to return to the 3-button screen.

2. Click the Start button and select the “Intouch Install Program” program. See Figure 6-2.

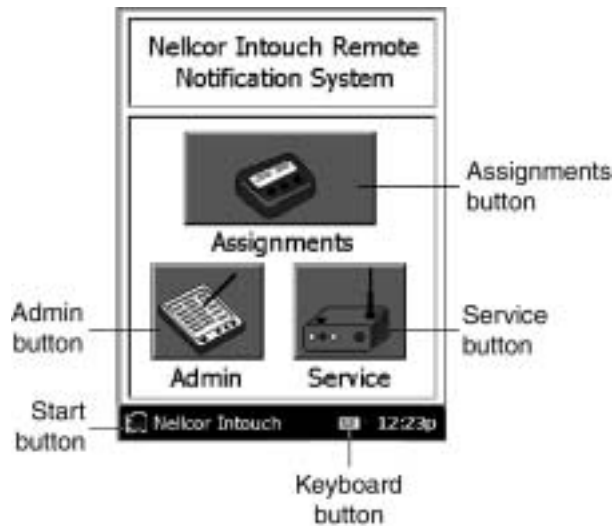

Figure 6-2: Start Button

3. The Intouch Install program password screen will be displayed. See Figure 6-3.

Note: If the Cancel button or an incorrect password is entered and the OK button is clicked, the programmer returns to the Intouch System Manager program.

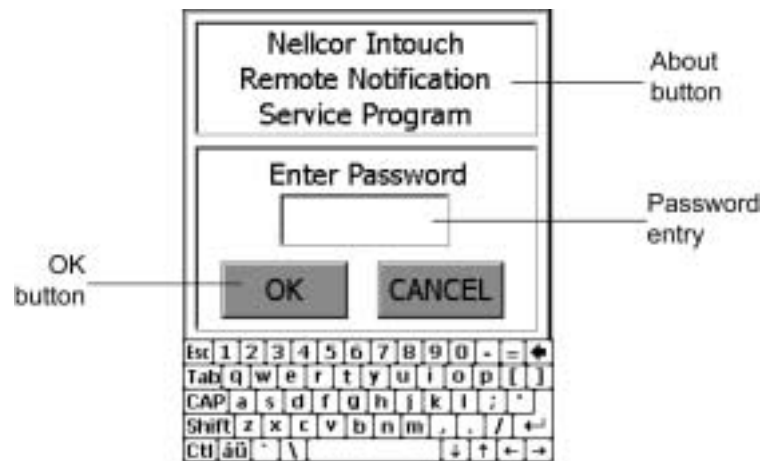

Figure 6-3: Password Screen

4. Press the Keyboard button to display the keyboard. See Figure 6-2. Use the keyboard to enter the password. The factory default password is "NPB." The password is not case sensitive.
5. Click the OK button. See Figure 6-3. The Intouch Install Alarms screen is displayed. See Figure 6-4.

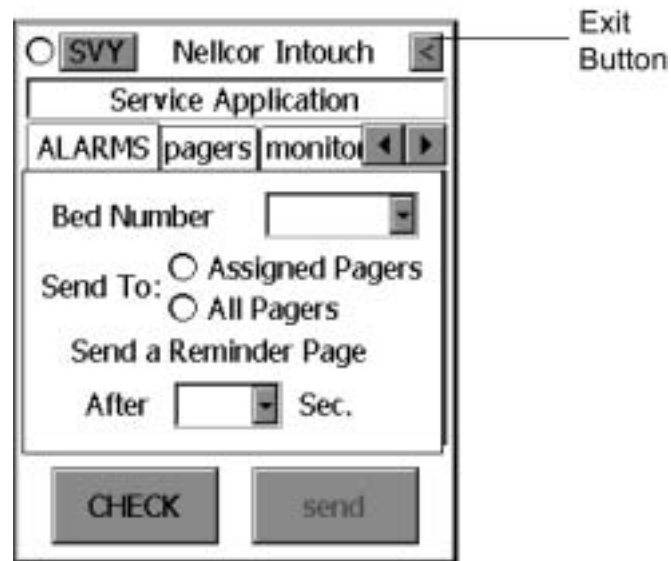

Figure 6-4: Installation Program Alarms Screen

Note: Clicking the Exit button exits the Install program and returns to the System Manager program.

6.3.2 Getting Transmitter Data

The NPB-290, NPB-295, N-395, and N-595¹ monitors must be in the ASCII Mode and set at a baud rate of 9600.

Before any parameters may be viewed or changed, you must load the current transmitter data into the programmer.

Note: Error Messages: When there is a communications problem between the programmer and the transmitter, an error message or an advisory message will appear. Refer to paragraph 5.9, page 5-6.

1. Point the programmer IR port at the transmitter IR port and click the programmer CHECK button. See Figure 6-4.
2. When the transmitter data has been loaded into the programmer, the programmer will display the "Transmitter Data Loaded" status message. See Figure 6-5.

¹ The N-595 must have software version 2.4.6 or lower to work with the Intouch system.

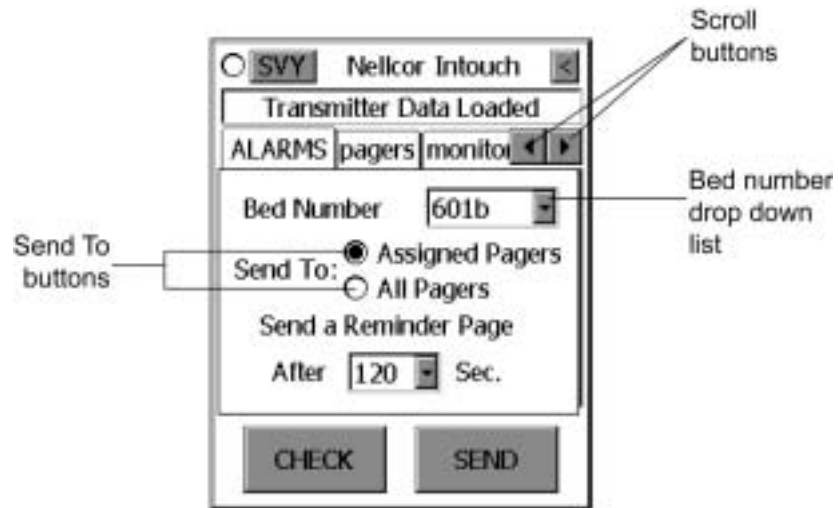

Figure 6-5: Transmitter Data Loaded Status Message

Note: If the desired Tab (ALARMS, PAGERS, MONITOR, SYS INF) is not visible, click the Scroll buttons to tab left or right. See Figure 6-5.

6.3.3 Changing Bed Number

1. From the Alarms screen, click the Bed Number Drop Down List down arrow. See Figure 6-5.
2. Select the desired bed number by clicking that bed number or by entering the bed number in the bed number window.

6.3.4 Selecting Pagers

Pagers must be separated from each other by four inches to eliminate interference between pagers.

1. From the Alarms screen, click the Send To: Assigned Pagers or All Pagers button. See Figure 6-5.
2. If Assigned Pagers is selected, and no pagers have been assigned, the "Pager Selection" page is displayed. See Figure 6-6.

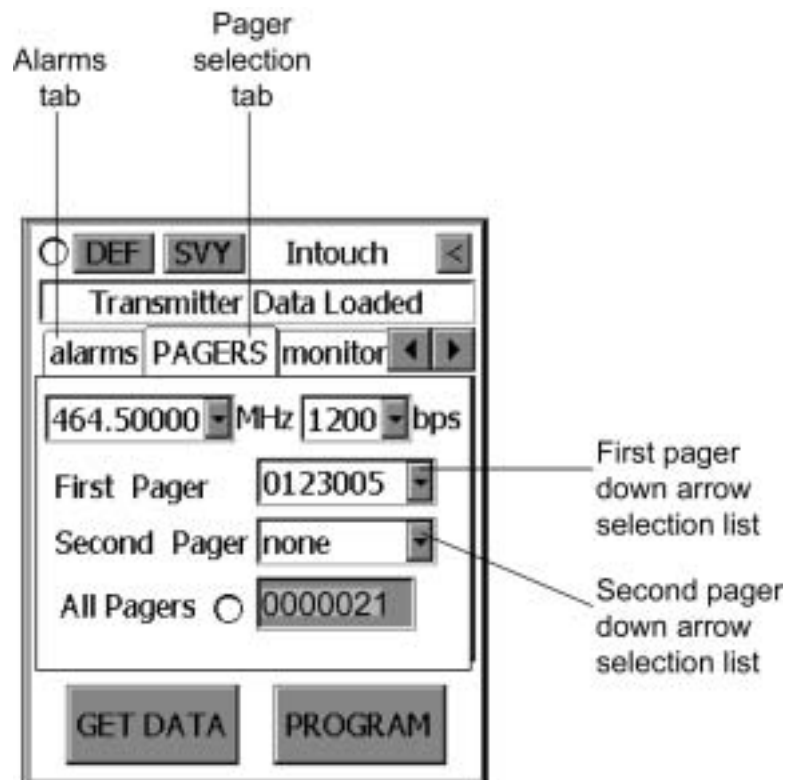

Figure 6-6: Pagers Selection Page Display

3. Click the "First Pager" down arrow selection list.

Note: Cap codes are 7-digit numbers unique to a specific pager. A pager's cap code corresponds to the last six digits of the pager's serial number (located on the back of the pager) plus a zero in front. For example, if a pager's serial number is 019691, its cap code is 0019691.

4. Select the desired pager by clicking the pager cap code number.
5. A maximum of two pagers may be selected. If two pagers are desired, click the "Second Pager" down arrow selection list.
6. Select the desired pager by clicking the pager cap code number.
7. Return to the Alarms screen by clicking the Alarms tab.

Note: The All Pagers cap code may be changed by clicking the text "All Pagers" and entering a different cap code using the keyboard.

6.3.5 Changing the Default Page Reminder Interval

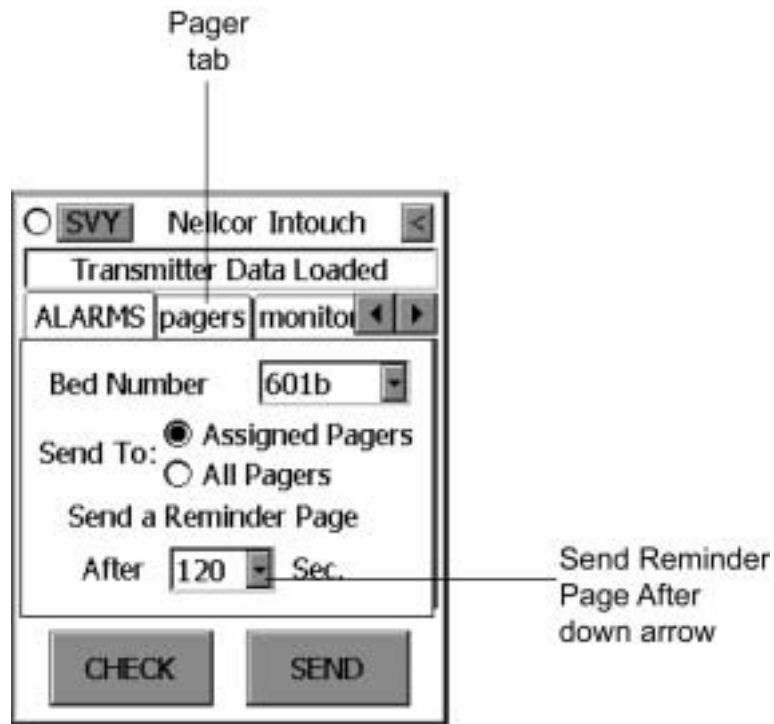

Figure 6-7: Alarms Screen

1. Click the "Send Reminder Page After" down arrow. See Figure 6-7.
2. Select the desired time interval by highlighting the time.

6.3.6 Changing System Configuration

All transmitters within the system must have the transmission frequency, bps (baud rate), and All Pagers Cap Code set to the same settings. See Figure 6-8. Pagers must be separated from each other by four inches to eliminate interference between pagers.

1. Click the Pagers tab. The pager configuration screen will be displayed. See Figure 6-8.

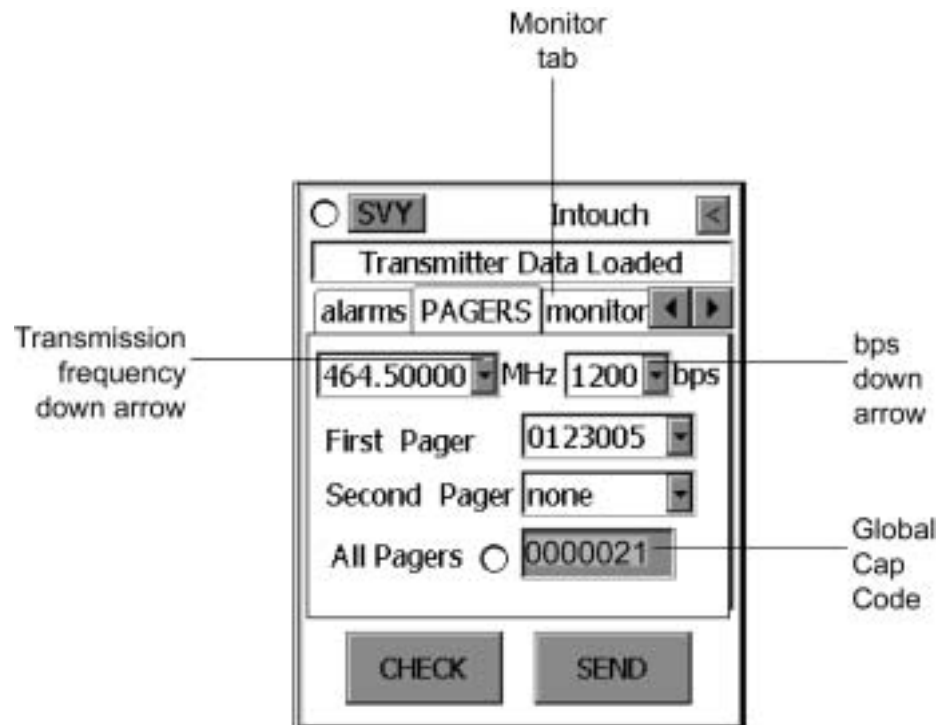

Figure 6-8: Pagers Configuration Screen

Note: The All Pagers cap code may be changed by clicking the text "All Pagers", and entering a different cap code using the keyboard.

2. To modify the transmission frequency, click the Sending Frequency Down arrow button and select the desired frequency. The transmission frequency is the frequency the Intouch transmitter transmits to the pager.
3. Click the desired frequency.
4. Set transmission baud rate by clicking the bps down arrow and selecting the baud rate that matches the pagers baud rate. The transmission baud rate must be the same as the pager's receiving baud rate.

6.3.7 Viewing Monitor Configuration and Changing Survey Page Configuration

The survey pages (Test Range button) are used to determine the range and coverage area of each transmitter. The time between pages and the number of pages may be selected using this procedure. Refer to Table 6-1 for the time between pages and Table 6-2 the number of pages available. Pagers must be separated from each other by at least 4 inches to eliminate interference between pagers.

Table 6-1: Survey Pages Intervals

Time Between Pages in Seconds
10
15
20
30
45
60
120

Table 6-2: Number of Survey Pages

Number of Pages
20
50
100
150
200

1. Click the Monitor tab to view the monitor configuration page. See Figure 6-9.

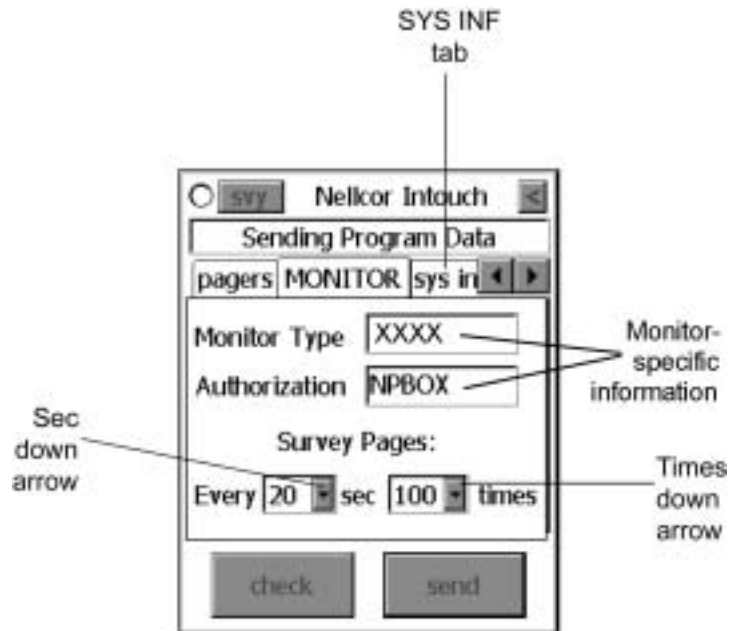

Figure 6-9: Monitor Configuration Screen

Note: The Monitor Type and Authorization fields display monitor-specific information obtained from the monitor.

2. To modify the Survey Pages intervals, select the sec down arrow.

3. Click the desired time interval.
4. To modify the number of Survey Pages, select the times down arrow.
5. Click the desired number of Survey Pages to be sent.

6.3.8 Programming Transmitter with the New Data

All of the changes made in the previous steps are now ready to program into the transmitter.

Note: Error Messages: When there is a communications problem between the programmer and the transmitter, an error message or an advisory message will appear. Refer to paragraph 5.9, page 5-6.

1. Point the programmer IR port at the transmitter IR port and click the Send button on the programmer screen. The programmer will display the Sending Program Data status message. See Figure 6-10.

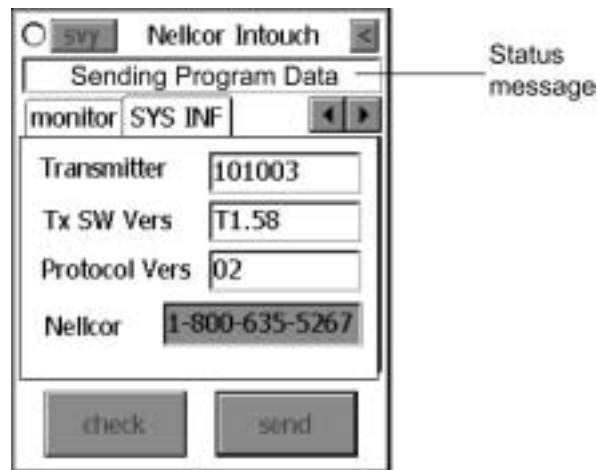

Figure 6-10: Sending Program Data Status Screen

2. When the transmitter has been successfully programmed, the Programming Successful status message will be displayed. See Figure 6-11.

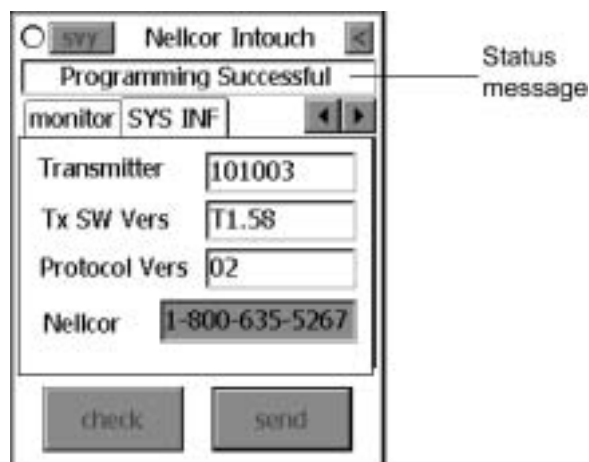

Figure 6-11: Programming Successful Status Screen

Note: The Nellcor phone number may be changed by clicking the text "Nellcor" and entering a different phone number using the keyboard.

6.3.9 Survey Paging

After the transmitter has been set up, it is advisable to perform a survey of the care unit to ensure that the transmitter and pagers are performing as desired. The applicable pagers should be moved around the care unit while the transmitter is sending the survey pages. Pagers must be separated from each other by at least 4 inches to eliminate interference between pagers.

1. To start the survey, point the programmer IR port at the transmitter IR port and click the SVY button. See Figure 6-11. The programmer will display the Survey Command Sent status message. See Figure 6-12.

Note: Survey paging cannot be initiated if the Intouch transmitter is communicating with the patient monitor.

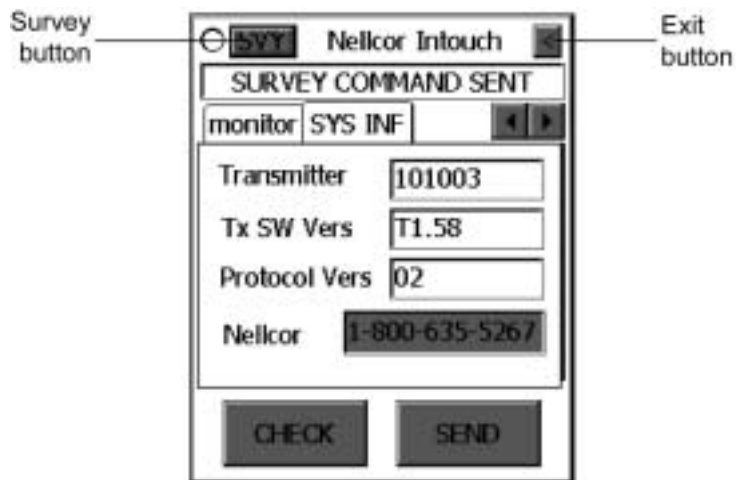

Figure 6-12: Survey Paging Started Status Screen

2. Exit the survey-paging program by clicking the Exit button.

6.3.10 Final Installation Check

This check is to ensure that all transmitters and all pagers are operating on the same frequency. This procedure will use one transmitter to page all pagers, two at a time. Then, each transmitter will page all pagers. Next, communication between each transmitter and a monitor will be checked.

Note: During this procedure, each pager must be separated by at least 4 inches to eliminate interference between pagers.

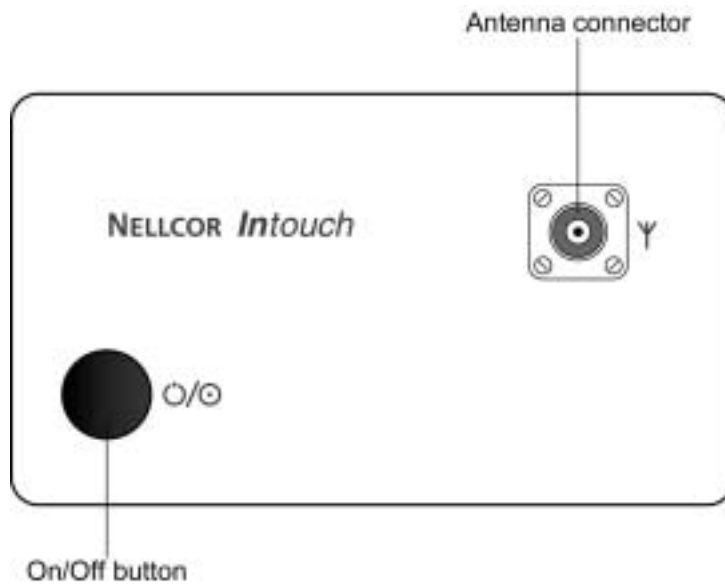

Figure 6-13: Transmitter Top View

1. Select one transmitter.
Note: Repeat steps 2 and 3 to cover all pagers.
2. Program selected transmitter to page two pagers. Refer to paragraph 6.3.4.
3. Press transmitter On/Off button to send a page. Ensure both pagers receive the page.
Note: Repeat steps 4 and 5 for each transmitter.
4. Program transmitters to page “All Pagers”.
5. Press transmitter On/Off button to send a page. Ensure all pagers receive the page.
Note: Repeat steps 6 and 7 for each transmitter.
6. Connect transmitter to monitor (paragraph 4.2).
7. Verify that the transmitter communicates with the monitor and a test page is sent to all pagers (paragraph 4.3).

6.3.11 Changing the Intouch Install Program Password

Note: You must know the current password in order to change the password in the Intouch Install Program.

1. Turn on the programmer by pressing the Power On/Off button. See Figure 6-14.

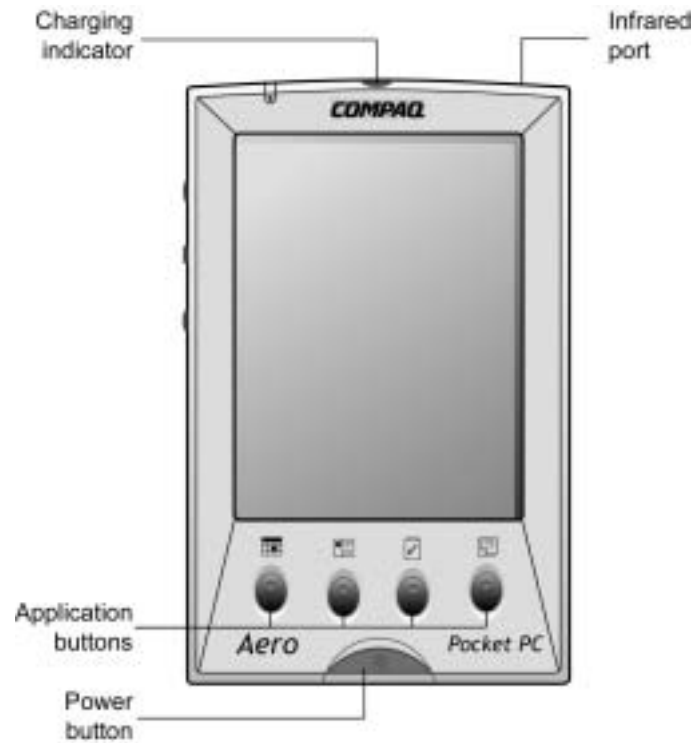

Figure 6-14: Programmer Power On/Off Button

2. Click the *Windows CE* program Start button and select Intouch Install Program.
3. Click the programmer's keyboard button to reveal the change password button. See Figure 6-15.
4. The Intouch Install Program password screen will be displayed.

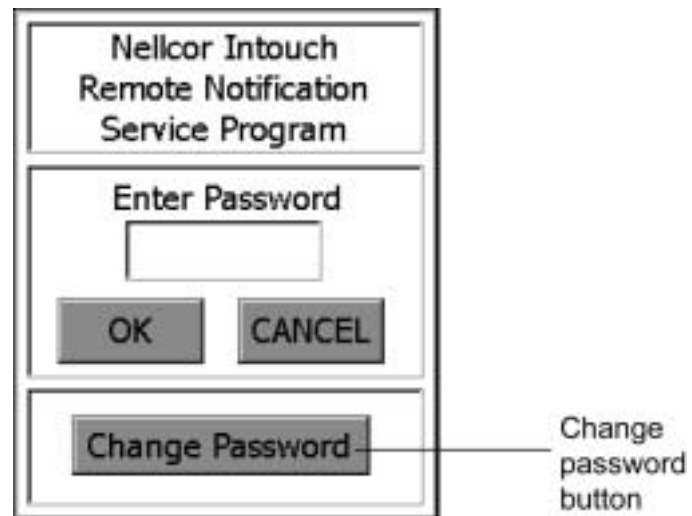

Figure 6-15: Password Screen

5. Click the Change Password button. The Enter Current Password screen will be displayed. See Figure 6-16.

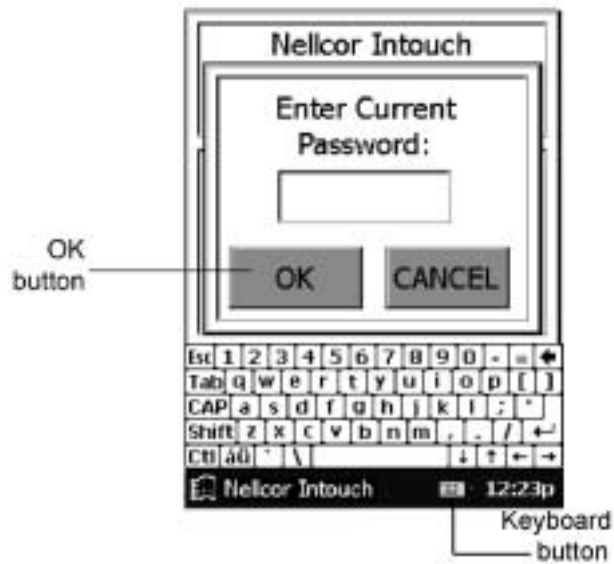

Figure 6-16: Enter Current Password Screen

6. Click the Keyboard button to display the keyboard. Enter the current password using the keyboard. The factory default password is "NPB." The password is not case sensitive.
7. Click the OK button.
8. Enter the new password using the keyboard. Nine characters maximum.
9. Click the OK button.
10. Click the programmer keyboard button to reveal the change password button. See Figure 6-17.

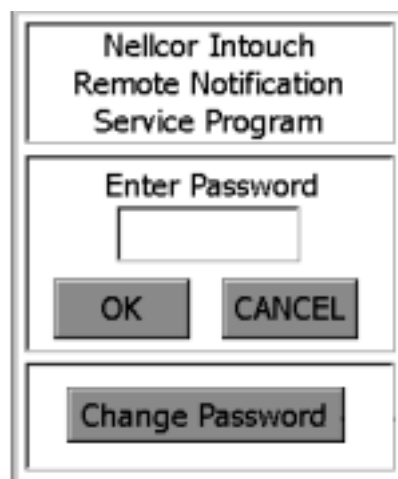

Figure 6-17: Installation Program Password Screen

11. Click the Change Password button. The programmer is now ready to respond to the new password.

Blank Page

SECTION 7: SPARE PARTS

7.1 INTRODUCTION

Spare parts are shown in Table 7-1. Item numbers correspond to the callout numbers in Figure 7-1.

The most recent revision of this manual is available on the Internet at:

http://www.mallinckrodt.com/respiratory/resp/Serv_Supp/ProductManuals.html

The most recent parts list for the Intouch system is on the Internet at:

http://www.mallinckrodt.com/respiratory/resp/Serv_Supp/Apartweb/Main/PartAcceMenu.html

Table 7-1: Parts List

Item	Description
1	Intouch Transmitter
2	7-inch Intouch Antenna
3	Intouch Transmitter Serial Cable (NPB-290, NPB-295, N-395, N-595 ¹)
4	Intouch Pager
5	Intouch Programmer
6	Intouch Transmitter Power Supply
7	AC Power Cord (for transmitter power supply)
--	Rechargeable, main battery pack for programmer
--	AC adapter/charging cord (for programmer)
--	Pager Clip-on Holder
	Programmer flash card with Intouch software

Figure 7-1 shows the components of the Intouch remote oximetry notification system.

¹ The N-595 must have software version 2.4.6 or lower to work with the Intouch system.

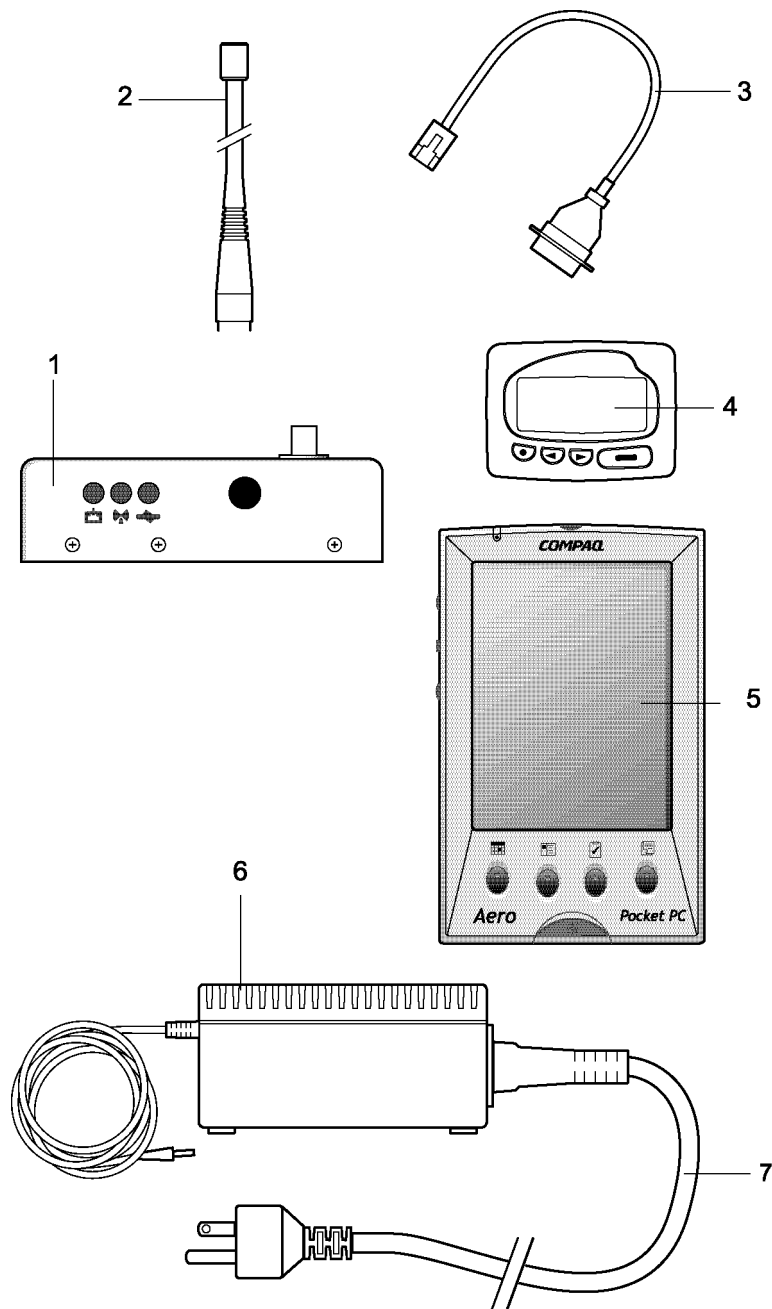

Figure 7-1: Intouch Remote Oximetry Notification System

SECTION 8: PACKING FOR SHIPMENT

8.1 Introduction..... page 8-1
8.2 General Instructions page 8-1

8.1 INTRODUCTION

To ship any component of the Intouch remote oximetry notification system for any reason, follow the instructions in this section.

8.2 GENERAL INSTRUCTIONS

Pack the Intouch remote oximetry notification system component(s) carefully. Failure to follow the instructions in this section may result in loss or damage not covered by any applicable Nellcor warranty. The best method to return component(s) of the Intouch remote oximetry notification system is to pack them in the original shipping container. If the original shipping carton is not available, use another suitable carton; North American customers may call Nellcor Technical Services Department to obtain a shipping carton.

Prior to shipping the Intouch remote oximetry notification system, contact your supplier or local Nellcor office (Technical Services Department, 1.800.635.5267) for a returned goods authorization (RGA) number. Mark the shipping carton and any shipping documents with the RGA number. Return the Intouch remote oximetry notification system component(s) by any method that provides proof of delivery.

Blank Page

SECTION 9: SPECIFICATIONS

9.1 System Specifications page 9-1
 9.2 Electrical page 9-1
 9.3 Environmental page 9-3
 9.4 Physical page 9-3

9.1 SYSTEM SPECIFICATIONS

9.1.1 Single Alarm Response Time

Patient alarms will be received by the pager within 10 seconds for single patient alarm events.

9.1.2 Multiple Alarm Response Time

In the case of separate, simultaneous alarms at five transmitters, all alarms will be received by the pager within 60 seconds.

9.1.3 Configuration

Within one Intouch system, up to 24 transmitters and 12 pagers may operate on one frequency and be programmable by one programmer.

Up to 6 sets of 24 transmitters, each set operating on its own channel, may be used in the same hospital or healthcare facility.

9.2 ELECTRICAL

9.2.1 Transmitter

FCC Approval	FCC part 90
Interference-Causing Equipment Standard Compliance	This ISM device complies with Canadian ICES-001
Frequency	UHF band, 450 – 466 MHz
Input Voltage	+15 volts, 1.5 amps
Data Port Input Voltage Requirements from a Modem for Proper Modulation	±1.5 VDC (3 VDC peak-to-peak)
Maximum Data Port Baud Rate	19,200 Baud
Data Port Designed Impedance	
Input resistance	3000 – 5000 ohms
Output resistance	10 megohms typical; 300 ohms minimum
Antenna Terminal Designed Impedance	50 ohms

Earth Terminal	The input side of the AC power supply is connected to earth ground. Functional ground is connected to the DC terminal (⊖) on the output side of the transmitter power supply.
Operating Range	From transmitter to pager, 150 feet (45.7 meters) with no intervening structures.
Battery	The transmitter can operate on battery power for approximately 45 minutes, sending one message every 10 minutes (at a baud rate of 512). Nellcor recommends that the battery be replaced every 2 years. Call Nellcor Technical Services at 1.800.635.5267 to make arrangements to send in your transmitter for battery replacement.

9.2.1.1 Radiated Immunity

The Intouch transmitter is immune to radiated radio-frequency electromagnetic fields of up to 3 volts per meter from 80 MHz to 1 GHz.

9.2.1.2 Conducted Immunity

The Intouch transmitter is immune to radiated conducted-frequency electromagnetic energy of up to 3 volts per meter from 150 kHz to 80 MHz.

9.2.2 Pager

The pager is FCC complaint.

9.2.2.1 Battery

The pager is powered by a AAA, alkaline battery. Under normal usage, the battery will last approximately 3 weeks.

9.2.3 Programmer – Compaq model 1550

The Compaq programmer operates on a lithium-ion rechargeable battery pack as its main DC power supply. The rechargeable battery pack has a usable life span of approximately 300 charge/discharge cycles. A full charge of a completely discharged battery takes approximately 3 hours.

The programmer also has a 3.0-volt, CR2032 coin cell backup battery that is used to preserve data in the programmer when the main battery pack has been exhausted or removed from the programmer.

9.3 ENVIRONMENTAL

9.3.1 Transmitter

Operating Temperature	0 to 45 °C (32 to 113 °F)
Storage Temperature	-20 to 60 °C (-4 to 140 °F)
Relative Humidity	5 to 95% non-condensing
Altitude	0 to 3048 meters (0 to 10,000 feet)

9.3.2 Pager

Operating Temperature	0 to 45 °C (32 to 113 °F)
Storage Temperature	-20 to 60 °C (-4 to 140 °F)
Relative Humidity	5 to 95% non-condensing
Altitude	0 to 3048 meters (0 to 10,000 feet)

9.3.3 Programmer – Compaq model 1550

Operating Temperature	0 to 40 °C (32 to 104 °F)
Storage Temperature	-20 to 60 °C (-4 to 140 °F)
Relative Humidity	20 to 90% non-condensing
Altitude	0 to 4,572 meters (0 to 15,000 feet)

9.4 PHYSICAL

9.4.1 Transmitter

Dimensions	13.3 x 3.8 x 7.6 cm (5.25 x 1.5 x 3 inches)
The transmitter complies with IEC 68-2-7 (mechanical shock).	

Blank Page

SECTION 10: TECHNICAL SUPPLEMENT

10.1 Introduction	page 10-1
10.2 Block Diagram	page 10-1

10.1 INTRODUCTION

This Technical Supplement provides the reader with a discussion of the Intouch remote oximetry notification system functional overview. A block diagram supports the functional overview.

10.2 BLOCK DIAGRAM

Figure 10-1 is the Intouch remote oximetry notification system block diagram.

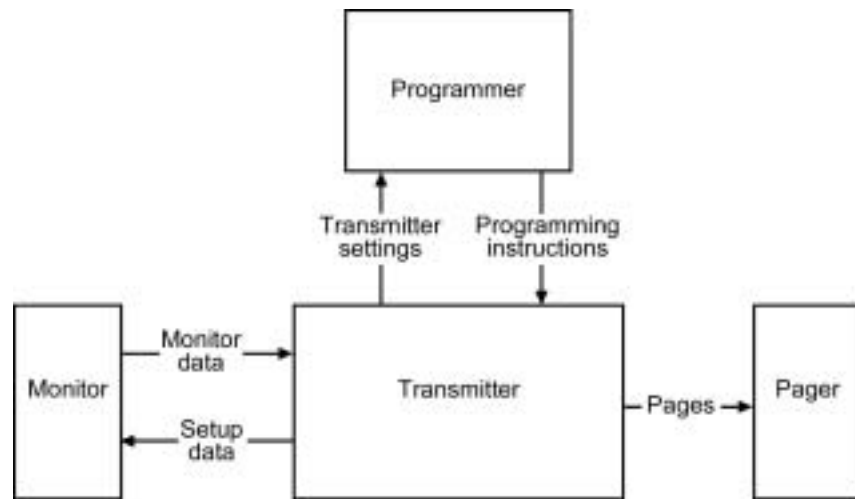

Figure 10-1: Intouch Block Diagram

10.2.1 Intouch Transmitter

The transmitter interfaces with an NPB-290, NPB-295, N-395, and N-595¹ pulse oximeter monitor. The transmitter relays patient alarm information to a clinician-worn pager. The data relayed from the pulse oximeter includes patient bed number, alarm type, and parameter values (heart rate and SpO₂ values).

Clicking the On/Off button until the pagers receive a “Programming OK” page changes the pagers selected to Global (All Pagers). This can only be done when the transmitter is not communicating with the monitor (i.e., disconnect the cable between the transmitter and monitor). This allows the transmitter to keep functioning when the programmer has been lost, misplaced, or damaged.

10.2.2 Intouch Programmer

The programmer is a palmtop computer running the *Windows CE* operating system program. The programmer comes preloaded with proprietary software used to configure the Intouch remote oximetry notification system.

¹ The N-595 must have software version 2.4.6 or lower to work with the Intouch system.

10.2.3 Intouch Pager

The pager is a clinician-worn pager device intended for use in a hospital/facility environment. The pager is a secondary means of annunciating patient alarm information, such as patient bed number, alarm type, pulse rate, SpO₂, and heart rate data.

SECTION 11: INDEX

A

Assignment program
download configuration, 4-9
entering, 4-9
pager, selecting, 4-10

B

Battery
monitor, 4-4. *See* monitor operator's manual
error, 5-6
pager
error, 1-2
replacement, 2-2, 9-2. *See* operator's manual
programmer
backup, 9-2
charging, 6-4, 9-2. *See* operator's manual
error, 5-2, 5-7
replacement, 7-1. *See* operator's manual
transmitter
charging, 6-4
error, 5-6
replacement, 2-2, 9-2
Baud setting
monitor, 4-4, 6-7
transmitter, 6-10, 6-11, 9-1
Bed numbers
assigning, 4-7
changing, 4-10
Block diagram, 10-1

C

Cleaning
pager, 2-1
programmer screen, 2-1
transmitter, 2-1
Compaq programmer
restore software, 5-2
Connecting the transmitter, 4-1

D

Disinfecting, 2-1

E

EMI, 5-8
Enclosure leakage current test, 3-3
Error messages, 5-6

F

Frequency verification
site survey, 6-2

I

Install program, 6-1
bed numbers, changing, 6-8
entering, 6-5
monitor configuration, viewing, 6-12
page reminder, changing interval, 6-10
pagers, selecting, 6-8
password, changing, 6-15
survey page, changing configuration, 6-12
survey paging, 6-14
system configuration, changing, 6-10
transmitter data, getting, 6-7
transmitter, programming, 6-13
Installation, 4-1
transmitter, 4-1
Intended use, 1-2

M

Manual overview, 1-1

P

Packing, 8-1
Pagers
assigning, 4-7
changing assigned, 4-10
selecting all without PDA, 10-1
Performance tests, 3-1
Performance verification, 3-1
POST, 4-5
Light Sequence, 4-6
Power-on self-test, 4-5
Programmer
restore software (Compaq), 5-2

R

Range test
site survey, 6-3
Related documents, 1-5
Reminder page
setting delay time, 4-11
Repairs
who should perform, 5-1
Replacement level support, 5-1
Replacement parts, 5-2
Returning equipment, 5-1

S

- Safety tests, 3-3
- Site survey, 6-2
 - final setup, 6-4
 - frequency verification, 6-2
 - programmer set up, 6-4
 - range test, 6-3
 - setup, 6-2
- Spare parts, 7-1
- System description, 1-2

T

- Technical Supplement, 10-1
- Test
 - enclosure leakage current, 3-3

- Test equipment, 3-1
- Test page, 3-3
- Transmitter
 - turn on, 4-5
- Transmitter installation, 4-1
- Transmitter placement, 4-2
- Transmitter program
 - entering, 4-11
 - page reminder interval, 4-12
 - transmitter data, getting, 4-12
 - transmitter programming, 4-13
- Transmitter range
 - testing, 4-13
- Transmitter settings
 - current, 4-7
- Troubleshooting, 5-1
 - error messages, 5-6
 - guide, 5-2

Blank Page

tyco

Healthcare

Nellcor

Tyco Healthcare Group LP
Nellcor Puritan Bennett Division
4280 Hacienda Drive
Pleasanton, CA 94588 USA
Toll Free: 1.800.635.5267

Rx ONLY

© 2003 Nellcor Puritan Bennett Inc. All rights reserved. 066053A-0803