

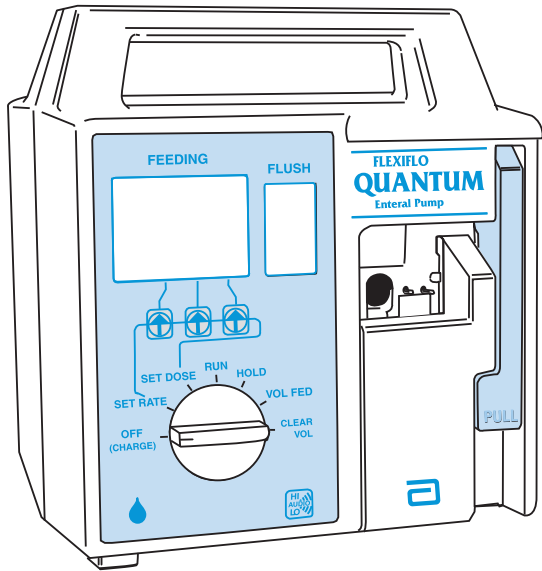

FLEXIFLO QUANTUM Enteral Pump



Operating Manual

*For Enteral Use Only
Not for IV Use*

CONTENTS

Pump Characteristics	3
Pediatric Use	4
Indications for Use	4
Precautions	5
Panel Displays	6
Control Dial Settings	7
Automatic Prime	9
Pump Sets	10
Instructions for Use	12
Battery Operation	13
Checking Pump Accuracy	14
Troubleshooting	15
Cleaning	18
Service	19
Specifications	20
Limited Warranty	21

USER QUALIFICATIONS

Caution: Federal (USA) law restricts this device to sale by or on the order of a physician or other licensed practitioner.

PUMP CHARACTERISTICS

The FLEXIFLO QUANTUM Enteral Pump is a microprocessor (computer)-controlled pump that provides for accurate, controlled enteral feeding in a safe, user-friendly system. The QUANTUM Pump is a volumetric pump that uses a specially designed pump set, which includes a cassette that delivers measured amounts of enteral product. As an optional feature, the QUANTUM Pump will flush the pump set and indwelling feeding tube each hour with a 25-mL flush.

The QUANTUM pump offers these features:

1. Automatic priming (no manual priming is necessary)
2. Automatic flush feature
3. Dose setting
4. Protection against overdelivery:
 - Motor speed is continuously monitored
 - Senses malfunctions that could result in gravity free flow
5. Volume-fed accumulation displays for enteral product and water
6. Flow-rate selection from 1 to 300 mL/hr in 1-mL/hr increments
7. Accuracy to $\pm 10\%$ or ± 0.5 mL/hr, whichever is greater (refer to CHECKING PUMP ACCURACY, page 14)
8. 8-hour battery operation at 125 mL/hr, when fully charged
9. Alarms:
 - **OCCLUSION**
 - **EMPTY**
 - **DOSE COMPLETE**
 - **TURN TO RUN**
 - **LOW BATTERY**
 - **DOOR/CASSETTE**
 - **SET RATE**
10. System self-check
11. Adjustable alarm volume
12. User-friendly operating controls
13. Simple setup (one-hand cassette loading)
14. Memory—Automatic retention of the following values until turned off and disconnected from AC power:
 - **FEED** and **FLUSH** volume accumulations (**VOL FED**)
 - **SET RATE**
 - **SET DOSE** values

PEDIATRIC USE

The Automatic Flush Mode must NOT be used for feeding infants under 12 months of age. In addition, use of the automatic flush feature in all pediatric patients 12 months of age or older must be carefully evaluated. A physician with training in pediatrics must take into account the effect of the additional volume on intestinal tolerance and overall fluid balance of the individual patient and should, accordingly, determine the maximum amount of water to be hung.

INDICATIONS FOR USE

The FLEXIFLO QUANTUM Enteral Pump can be used with pediatric patients provided the patients can tolerate a feeding range within the pump's operational specifications. Those specifications are as follows:

- The flow rate range of the QUANTUM pump is 1-300 mL/hr in 1-mL increments.
- The flow rate accuracy of the pump is $\pm 10\%$ (see the QUANTUM operating manual for checking pump accuracy).
- The mean occlusion pressure limit of the QUANTUM pump is 15 psi.

If these specifications are not appropriate for a given patient, the QUANTUM pump should not be used.

PRECAUTIONS

NOT FOR IV USE

Confirm proper placement and function of patient's enteral feeding tube (nasogastric, nasojunal, gastrostomy, etc.). Failure to do so may result in vomiting and/or aspiration.

BOLUS FEED

Enteral pumps may have the potential to bolus-feed or overdeliver, which is an important consideration in feeding volume-sensitive patients. In these patients, do not hang more volume of nutritional product than can be tolerated as a bolus and monitor the patient closely, or as directed by a physician.

FLUSH MODE

Caution should be exercised in the use of this pump in the Automatic Flush Mode for patients with volume sensitivity or fluid restriction (ie, cardiac, renal, pulmonary or pediatric patients). For such patients, the Feed Only Mode (using the system without automatic flush feature) may be desired.

ELECTRICAL EMISSION

Low level electrical emissions are commonly observed when fluids are administered using an enteral feeding pump. The emissions observed with the QUANTUM Pump may create artifacts on voltage sensing equipment such as ECG, EMG, and EEG monitoring devices if the monitoring device is not operating correctly or has loose or defective connections to its sensing electrodes. These artifacts may be mistaken as actual physiologic signals, and may vary at a rate that is associated with the delivery rate set on the pump. To determine if the abnormality in the monitoring device is caused by the QUANTUM Pump, set the pump so it is temporarily not delivering fluid. Disappearance of the artifact indicates it was probably caused by the pump. Proper setup and maintenance of the monitoring device should eliminate the artifact.

MIXING OF PRODUCT

PRECAUTION: This pump is designed to deliver only a liquid enteral feeding product (standard liquid product, infant formula or reconstituted powder product that has been thoroughly mixed into solution).

PRODUCT CONTAMINATION

To avoid enteral product bacterial contamination, pump set and container should be replaced as prescribed on nutritional feeding set labeling. For single-patient use only.

PUMP SERVICING

Only Abbott Nutrition-authorized personnel are permitted to service this medical device. Unauthorized personnel should not open the pump or repair/replace any components, including labeling.

PANEL DISPLAYS

Here is a simple explanation of the panel displays. Understanding them is necessary for successful operation of the pump.

FRONT PANEL

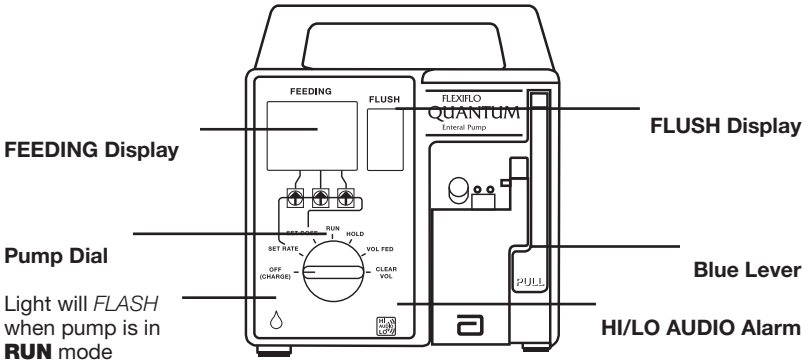

BACK PANEL

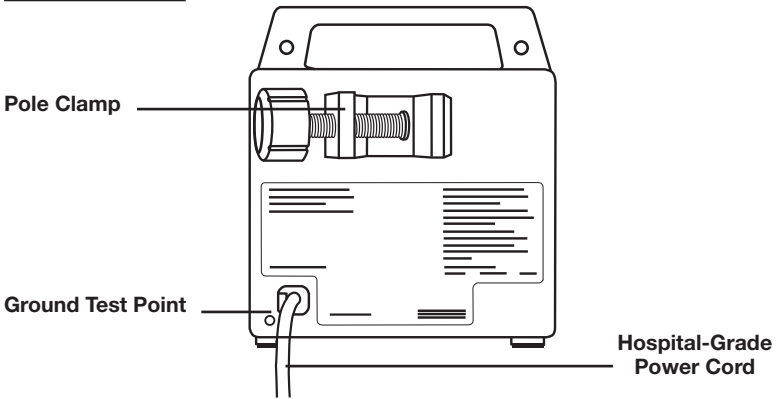

BOTTOM VIEW



CONTROL DIAL SETTINGS

DIAL:

FUNCTION:

OFF (Charge)

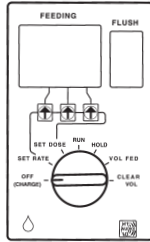

Stops all pump functions. Battery charges in all dial settings when pump is plugged in. The pump will retain current **RATE**, **DOSE** and **VOL FED** values indefinitely *unless* the pump is unplugged from an AC power source while in the **OFF (CHARGE)** setting.

SET RATE

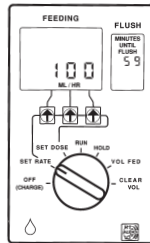

Allows flow rate to be set (1 to 300 mL/hr in 1-mL increments) by pressing the keypad arrows when the pump is in the **SET RATE** mode. Rate may be set during or after the automatic priming phase.

SET DOSE

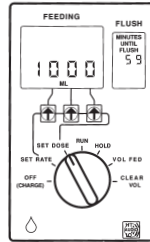

Allows dose to be limited (1 to 1999 mL for Models A, B & C and 1 to 9999 mL for Model D and higher, in 1-mL increments) by pressing the keypad **DOSE** arrows. Completion of this dose triggers **DOSE COMPLETE** alarm. Refer to **DOSE COMPLETE** (page 15). **DOSE** may also be set during the automatic priming phase. **NOTE:** If zero dose is entered (0000), this feature is deactivated.

RUN

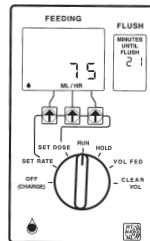

Only setting that activates feeding. Visual display shows rate of flow in mL/hr and a droplet-shaped image will move across the bottom of the visual display. Also, a small green light on lower left-hand corner of pump will flash when pump is in **RUN** mode.

CONTROL DIAL SETTINGS (continued)

DIAL:

FUNCTION:

HOLD

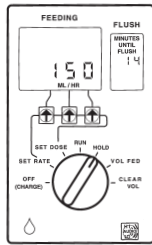

Stops pumping action and audio alarms. **HOLD** is used when correcting an alarm condition or whenever temporary cessation of pumping action is desired (such as when connecting a new feeding container). If pump dial is left on **HOLD** for more than 5 minutes, an alarm will sound and the message **TURN TO RUN** will be displayed.

VOL FED

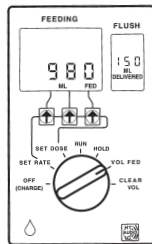

Stops pumping action. The **FEEDING** display will show feed volume delivered and the **FLUSH** display will show flush volume delivered. Pump accumulates feed volume delivered up to 9999 mL and flush volume up to 999 mL unless these volumes are reset to zero by turning to **CLEAR VOL** (or the pump is unplugged while in the **OFF [CHARGE]** mode). Upon exceeding the maximum feed or flush volume allowed on the display, the value turns to zero and a new accumulation begins.

CLEAR VOL

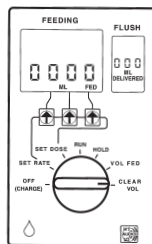

Stops pumping action and clears both the feed and flush volume fed to zero. **NOTE:** The pump will “beep” four times before erasing volumes to alert the user that the dial has been turned to **CLEAR VOL**. The user must turn dial away from **CLEAR VOL** (to any other setting) *before* the fourth beep to avoid an unintentional erasure of volume total(s).

CLEAR VOL does not work while pump is priming.

AUTOMATIC PRIME

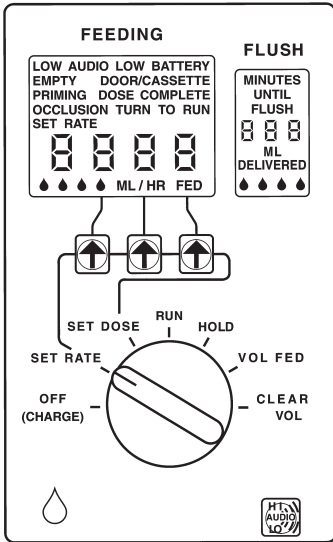

System Self-Check Display

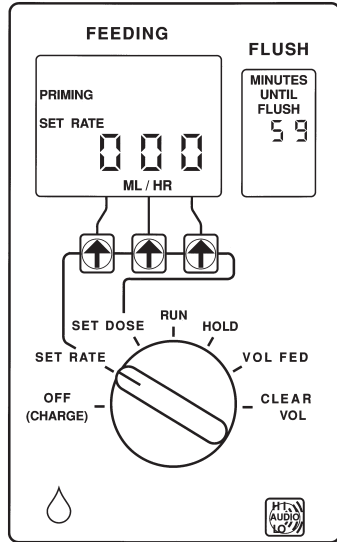

Priming Display

Automatic Priming is initiated when:

Pump dial is turned from **OFF (CHARGE)** position to **SET RATE**, **SET DOSE** or **RUN** position. The system self-check on the pump is followed by automatic priming of the set. Fluid fills the tubing during this priming sequence. This fluid is not counted in **VOL FED**.

- **NOTE:** Automatic priming expels air from the set, which may result in a small amount of fluid being expelled beyond the adapter on the pump set.
- Ensure that the set is fully primed and the pump has gone through the self-check process prior to attaching the adapter to the enteral feeding tube.

Automatic Priming does not occur in the following dial settings:

HOLD

VOL FED

CLEAR VOL

PUMP SETS

The FLEXIFLO QUANTUM Enteral Pump offers a wide choice of pump sets with either a Pump Set Without Flush Bag (single inlet cassette) or Pump Set With Flush Bag (dual inlet cassette).

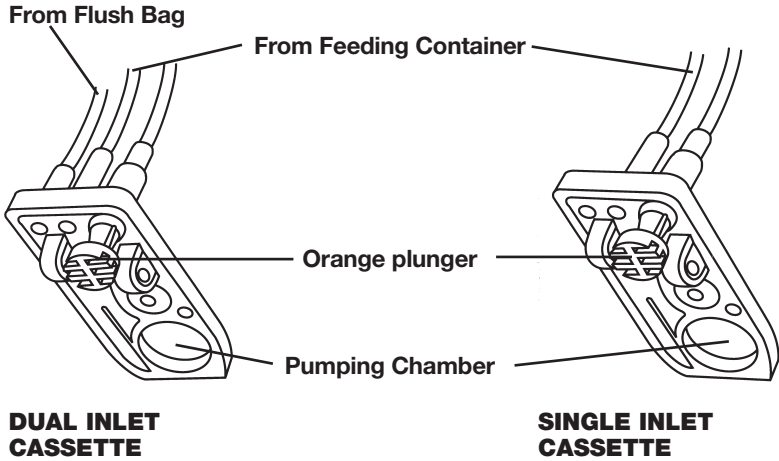

IMPORTANT REMINDER WHEN USING A PUMP SET (WITHOUT FLUSH BAG):

- **FLUSH** display will be blank when a single inlet cassette is used.

PUMP SETS (continued)

PUMP SET (WITH FLUSH BAG)—DUAL INLET CASSETTE

EXAMPLE SHOWN:

FLEXIFLO® Top-Fill Enteral Nutrition Container

With Preattached QUANTUM Pump Set With Flush Bag

IMPORTANT REMINDER WHEN USING FEED/FLUSH SETS:

- Every 60 minutes of continuous feeding *AND* before the pump alarms **EMPTY**, **DOSE COMPLETE** or **LOW BATTERY**, 25 mL of water will be delivered over 1½ minutes. Flush rate is fixed at 999 mL/hr.
NOTE: The **FLUSH** cycle will be aborted if the control knob is turned to any position other than **RUN**, **HOLD** or **VOL FED**.
- Ensure that the clamp on the filled flush bag is open during priming. Otherwise, the pump will not recognize that a Pump Set With Flush Bag is in place, and the **FLUSH** display will remain blank.
- When the door on the pump is open, be sure both clamps are closed. Otherwise, the fluids will mix.
- Use of the QUANTUM Pump replaces the need for *routine* flushing procedures (eg, 20-30 mL of warm water every 4-6 hours during *continuous* feeding).
- Flushing with 20-30 mL of warm water (using a 30-mL or greater syringe) before and after medications is still recommended.
- If pump feeding is manually stopped or turned off, automatic flushing does not occur. If pump remains in the **OFF (CHARGE)** mode (not on **HOLD**), it is recommended to flush with 20-30 mL of warm water (using a 30-mL or greater syringe) to rinse remaining product from the pump set.
- Additional information or action may be included in your facility's required procedures.

INSTRUCTIONS FOR USE

Before initial use on battery power and after extended storage periods, the pump must be plugged into an AC power source for a minimum of 8 hours (pump may be operated during this time).

DANGER: Possible explosion hazard if used in the presence of flammable anesthetics.

Ensure that the orange plunger is completely pushed in and seated and flush bag tubing slide clamp is closed before set-up.

Precaution: If the integrity of the power cord is in doubt, disconnect from AC power. Return pump for servicing.

TO ASSEMBLE:

1. Attach pump to stand using pole clamp. To ensure stability of a portable stand, position the pump no higher than 36 inches from the floor. Plug in cord if power is available. If using battery power, do not let battery run down. When the low battery message appears, the battery has approximately 30 minutes of energy left.
2. Lift blue lever on face of pump to open door. Make sure orange plunger knob is oriented to the left as you firmly seat cassette into pump cavity. Close door on pump by pushing the blue lever down. (See illustration.)

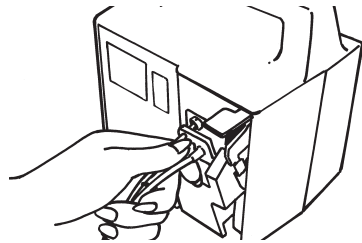

Refer to set Directions for Use for priming/feeding.

BATTERY OPERATION

When pump is unplugged, power is supplied by the internal, rechargeable battery.

1. If battery is fully discharged and AC power fails during feeding, pump will shut down and no alarm will sound.
2. While pumping, the display light turns off after approximately 2 minutes to save power.
3. Pump can be used while the battery is recharging. Pump automatically charges the battery when plugged into AC power.

Expected Life and

Charge Time:

1. When battery is fully charged, pump will operate for 8 hours at 125 mL/hr.
2. Battery will fully charge in 8 hours with the pump turned off and 12 hours with the pump turned on.
3. The battery will charge in any control dial setting including the **POWER OFF** position when connected to AC power.
4. When low battery alarm occurs, the pump will operate for approximately 30 minutes before shutting down.
5. Battery operating time will diminish with partially charged or older batteries. Operating on AC power and keeping the pump plugged into an AC outlet (even while OFF), will help maintain expected battery performance.

Battery Maintenance:

1. Before initial use on battery power and after extended storage periods, the pump must be plugged into an AC power source for a minimum of 8 hours.
2. A battery that has repeatedly been fully discharged and/or left in a discharged state for an extended period may not recharge properly.
3. If battery is rarely used, occasionally operating pump on battery power may extend battery life. The pump should be operated on battery for a minimum of 6 continuous hours at least once every 6 months for best performance and battery life.
4. The pump should be plugged into AC power whenever possible. When not being used on battery power, pump should **ALWAYS** remain plugged in to AC power to maintain battery charge and performance.

CHECKING PUMP ACCURACY

Fluid head height and viscosity are two variables that can affect flow rate. To check flow rate, use the following procedure.

Select a **new pump set without a flush bag (or fully close clamp on flush bag, if using a pump set with flush bag)**. Be sure to use a graduated cylinder for volume measurement—not an enteral container. Using Osmolite® 1 Cal, fill the pump set only and set up pump according to instructions. Suspend bag to side of or behind and 20 inches above pump (see illustration). With a test pump connected to AC power, start the pump and let it run for 15 minutes. Then run product into a graduated cylinder for 30 minutes and compare to rate set on pump:

<i>Rate Set</i>	<i>Amount Expected in Graduated Cylinder @ 30 minutes</i>
<u>76 mL/hr</u>	<u>= 34.2 mL to 41.8 mL</u>
150 mL/hr	= 67.5 mL to 82.5 mL

If amount in graduated cylinder is incorrect based on **SET RATE**, try a new pump set and repeat procedure.

Note: Mixing additives into the nutritional product may result in the pump delivering below specification.

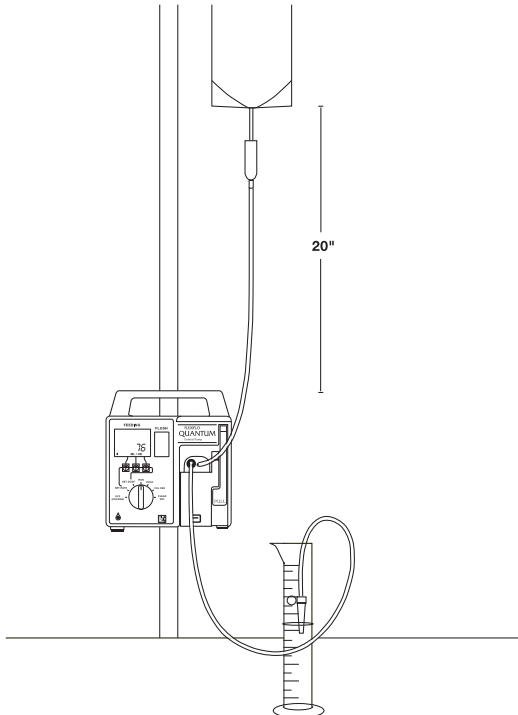

TROUBLESHOOTING

The FLEXIFLO QUANTUM Enteral Pump is designed to be highly reliable. However, if problems occur, the following tips will help correct minor in-service problems that may arise:

Intermittent audio alarms accompanied by messages on the front panel indicate the cause of the alarm for all alarm conditions except **LOW AUDIO** (visual only), which indicates low alarm volume has been selected.

VISUAL DISPLAY	CONDITION OR PROBLEM	EXPLANATION OR CORRECTIVE ACTION
OCCCLUSION	Flow has stopped.	<ul style="list-style-type: none"> • Turn dial to HOLD. • Clear obstruction/check for kinked tubing or closed clamp(s). • Turn dial to RUN to start pump.
EMPTY	Feed or Flush Bag empty.	<ul style="list-style-type: none"> • Turn dial to HOLD. • Refill container(s). • Turn dial to RUN to start pump.
DOSE COMPLETE - VOL FED is equal to the SET DOSE	Pump stops.	<ul style="list-style-type: none"> • Turn dial to SET DOSE. • Press keypad arrows to increase dose or to zero dose setting OR turn dial to CLEAR VOL. • To silence alarm, turn dial to HOLD, then RUN.
SET RATE	Dial turned to RUN without entering rate.	<ul style="list-style-type: none"> • Select flow rate (1-300 ml/hr). • To silence alarm, turn dial to HOLD, then RUN.
TURN TO RUN	Pump dial in setting other than RUN or OFF more than 5 minutes.	<ul style="list-style-type: none"> • Turn the dial to HOLD or RUN to reset.
DOOR/ CASSETTE	Door open, cassette not properly loaded or excess foam or air in cassette.	<ul style="list-style-type: none"> • Confirm cassette is in place and close door. • Manually reprime to remove foam or air from cassette. • Replace set. • If alarm condition persists, pump requires service.

TROUBLESHOOTING (continued)

VISUAL DISPLAY	CONDITION OR PROBLEM	EXPLANATION OR CORRECTIVE ACTION
LOW BATTERY	<p>Pump has approximately 30 minutes of battery operation before complete shutdown. A completely blank front panel (no lights, symbols, message) indicates that the battery is depleted and the unit is not plugged into a live AC circuit.</p> <p>NOTE: Complete shutdown is preceded by a continuous alarm for 1 minute.</p>	<ul style="list-style-type: none"> • Plug power cord into AC outlet. • Turn dial to HOLD, then RUN. Pump will operate normally while battery is charging.
ERR	System Malfunction.	<p>Must turn pump OFF to reset. If alarm condition persists, pump requires service.</p>
<p>FLUSH Display blank with FEED/FLUSH SET in use</p>	<p>Clamp is closed on the Flush Bag or Flush Bag is empty.</p>	<ul style="list-style-type: none"> • Turn pump OFF. • Fill Flush Bag. • Open clamp. • Restart pump.

TROUBLESHOOTING (continued)

Other Problems that may require pump service:

VISUAL DISPLAY	CONDITION OR PROBLEM	EXPLANATION OR CORRECTIVE ACTION
Visual Display frozen (pump operation froze with or without an alarm)	System Malfunction	Pump service is required - contact Abbott Nutrition
Pump dropped / fallen	Possible System Malfunction (internal or external damage)	<ul style="list-style-type: none">• Visually check and ensure no external damage is present• Remove cassette door and ensure / verify all pins are present (see Cleaning section)• Ensure proper function of the pump by performing the functional test listed in Checking Pump Accuracy• If one or more items listed above could not be verified, DO NOT USE THE PUMP. Service is required, contact Abbott Nutrition

CLEANING

There are no routine calibration or adjustment procedures required with the FLEXIFLO QUANTUM Enteral Pump.

For trouble-free operation, check the pump daily and clean immediately after spills occur.

While cleaning the pump, it should be turned off and unplugged. Do not submerge, autoclave, heat, steam, ETO or radiation sterilize the pump.

THE PUMP CAN BE CLEANED AS FOLLOWS:

HOUSING

- Clean outside surface only. DO NOT SPRAY WATER OR CLEANING SOLUTION INTO PUMP.
- For general cleaning, use a soft, lint-free cloth to avoid damaging the surface. Be especially careful with the operator's panel. If necessary, mild warm, soapy water may be used sparingly. Avoid the use of all strong solvents or cleaners, as these will damage the pump.
- Disinfection is recommended for all external parts and surfaces. Clean the pump before disinfecting it. Wipe on the disinfectant for at least one minute; then allow pump to air dry.
- Intermediate level disinfection is achieved by using one of the following: 10% concentration of 5.25% sodium hypochlorite (household bleach) or 70% isopropyl alcohol.

NOTE: These recommendations are not substitutes for official procedures that may differ among institutions.

PUMP CAVITY

To facilitate cleaning, the cassette receptacle door may be disconnected from the face of the pump. This can be removed in the following manner:

- Tilt pump back.
- Lift blue lever so cassette door is in open position.
- Push out on door-release tab to release cassette door.
- Allow door to open fully.
- Lift up on door to remove completely from brown hinge.

Reinstall cassette door by following above procedures in reverse order.

- Do not spray water or cleaning solution into pump cavity.
- Clean with a cotton swab, soft brush, or soft cloth and warm, soapy water.
- Dry thoroughly.
- Be sure no soap film or residue is left in the pump cavity.
- Ensure that all 6 pins are present following the cleaning process.

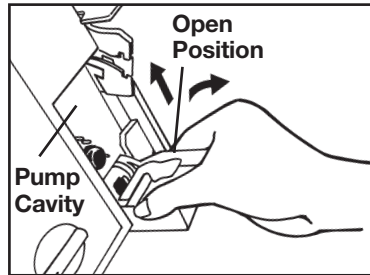
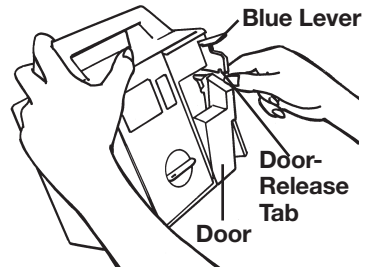

SERVICE

- The FLEXIFLO QUANTUM Enteral Pump is designed to be highly reliable. However, in the event of a pump malfunction, or for technical assistance, please contact Abbott Nutrition, Abbott Laboratories.
- OPERATING INSTRUCTIONS VIDEO
An instructional video, which is available through an Abbott Nutrition representative, assists caregivers and medical professionals in learning procedures for operating the Quantum enteral delivery system.
- Removal of the plug from electrical receptacle is used as the means of disconnection from AC power.
- Only Abbott Nutrition-authorized personnel are permitted to service this medical device. Unauthorized personnel should not open the pump or repair/replace any components, including labeling.

SPECIFICATIONS

POWER

Voltage:	120 VAC, 47-63 Hz, 1 Phase
Power:	4 watts (average)
Fuse:	½ AMP, SB type
Line Cord:	Hospital-grade, nondetachable (10 feet)
Leakage:	Less than 100 microamps

MECHANICAL

Height:	8.25 inches
Width:	7.5 inches
Depth:	6.0 inches (8.0 inches with pole clamp)
Weight:	7.2 pounds
Range:	1–300 mL/hr
Increments:	1 mL/hr
Accuracy:	±10% or ±0.5 mL/hr, whichever is greater (refer to CHECKING PUMP ACCURACY, page 14).
Pressure:	Pumps against 15 psi (mean) back pressure before occlusion alarm.
Operating Temperature:	50°F - 104°F (10°C - 40°C)
Operating Humidity:	20% RH - 80% RH, non-condensing
Operating Altitude:	The system is capable of operating as specified at elevations up to 10,000 feet (3,050 meters) above sea level.

STORAGE

- Be sure pump dial is in the **OFF** position.

Storage Temperature:	32°F - 95°F (0°C - 35°C)
Storage Humidity:	10% RH - 90% RH, non-condensing
Storage Altitude:	The system is able to withstand and operate after exposure to elevations up to 20,000 feet (6,100 meters) above sea level.

BATTERY

Battery Type:	2.1 Ah rechargeable sealed lead acid
Voltage:	8 V
	Refer to Battery Operation section on Page 13.

STANDARDS

Designed and manufactured to meet requirements of Underwriters Laboratories or Canadian Standards Association.

EXPLANATION OF SYMBOLS



Type BF applied part

LIMITED WARRANTY

The Abbott Nutrition Division of Abbott Laboratories warrants FLEXIFLO QUANTUM Enteral Pump purchased as a newly manufactured unit against defects in materials and workmanship for a three (3)-year period from date of shipment and warrants purchase of each remanufactured/used QUANTUM Pump for a twelve (12)-month period from date of shipment. This warranty does not extend to any product, or part thereof, that has been subjected to accident, alteration, damage, misuse, or repair by any party other than Abbott Nutrition authorized personnel, or has not been used in the manner prescribed in the Operating Manual or that at the time of pump failure was being used with pump sets or containers other than Abbott Nutrition pump sets and containers.

Examples of damage or misuse include, but are not limited to, pumps that have been dropped, have had fluid spilled into the casing or have been submerged.

In no event shall Abbott Nutrition be liable for any incidental, indirect or consequential damages in conjunction with the purchase or use of the pump, even if advised of the possibility of the same.

Abbott Nutrition reserves the right (at its option) to repair, or replace any pump that fails to meet the foregoing warranty.

THE WARRANTIES HEREUNDER ARE IN LIEU OF ALL OTHER WARRANTIES, EXPRESSED OR IMPLIED, INCLUDING, WITHOUT LIMITATION, THE WARRANTIES OF MERCHANTABILITY AND OF FITNESS FOR A PARTICULAR PURPOSE.

NOTE: When repairs on the newly manufactured unit are made under warranty because of faulty material or workmanship within three (3) years from the date of shipment (12 months for purchase of a remanufactured/previously used unit), the customer will not be billed for parts repaired, or replaced. Also, the customer will not be charged for labor involved in connection with the installation by Abbott Nutrition of such parts furnished under warranty.

Abbott shall have no responsibility or liability for the actions or inactions of unauthorized personnel performing such repair or service.

Shipping costs for units returned to Abbott Nutrition, including loaners, shall be paid by the customer. The units should be properly packaged and promptly returned. Loss or damage in return shipment to Abbott Nutrition shall be at the customer's risk.

Abbott Nutrition authorization should be obtained prior to return of the unit.

NOTES

NOTES

#50596/50598 36895

Rev. 08/09 LITHO IN USA

Abbott Nutrition
Abbott Laboratories
Columbus, Ohio 43229 USA

