

Dräger



Inkubatoren 7320 und 7520

From Dräger: Incubators 7320 and 7520

Important Notice

For correct and effective use of the apparatus, and to avoid hazards, we wish to point out the following:

- 1 Any use of the apparatus requires precise knowledge and observation of these operating instructions.
- 2 The apparatus is intended only for the purposes specified in the operating manual or for purposes specified in writing by Drägerwerk AG.
- 3 The apparatus must be inspected at regular intervals by qualified personnel (inspection = determination of actual condition). An official record of inspections must be kept.
- 4 Drägerwerk AG stipulates six-monthly maintenance (maintenance = inspection and servicing and, if applicable, repair) to be performed by qualified personnel. An official maintenance record must be kept. Only

genuine Dräger spare parts may be used when carrying out repairs.

- 5 We recommend that inspections, servicing and repair work be carried out by Drägerwerk AG. Regular inspections and servicing are best ensured by concluding a Service Contract with your Dräger subsidiary or distributor.
- 6 For reasons of safety, pressure reducers should be overhauled at least every 6 years.
- 7 In the interests of the safety of patient and staff apparatus may only be used in rooms which are wired and equipped in accordance with VDE 0107.
- 8 The apparatus is not approved for use in areas of explosive risks.
- 9 Responsibility for reliable functioning of the apparatus is transferred to the

owner or operator in all cases where the apparatus has not been properly maintained or repaired by persons not employed by the Dräger subsidiary or distributor in question or if it has been used in a manner which does not conform to the specified conditions of use.

Drägerwerk AG, its subsidiaries and distributors are not liable for damage which arises as a result of non-observation of this Important Notice. Warranty and liability stated or implied in the sales and delivery conditions of Drägerwerk AG, its subsidiaries or distributors are not extended by the above Important Notice.

We also wish to point out that the national recommendations, regulations and laws governing the use of technical equipment should be observed.

DRÄGERWERK AG LÜBECK

Contents

	Page		Page
Important Notice	2	4 Initial Preparation	12
1 Intended Use	3	5 Operational Use	12
2 Technical Data	3	6 Trouble Shooting	14
3 Design and Mode of Operation		7 Care and Servicing	15
3.1–3.7 Standard Equipment		8 Order List	18
3.8 Accessories	4–11	9 Dimensional Drawings	20

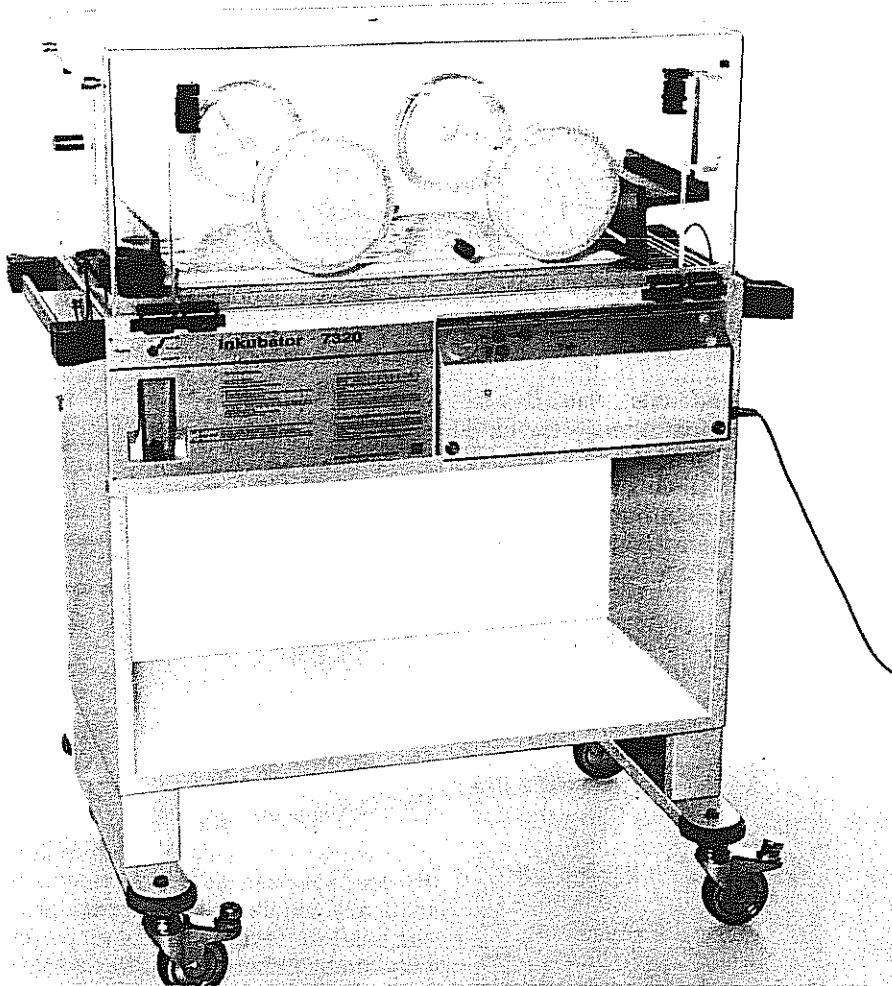

Fig. 1 a Incubator 7320 (with trolley and unit 7021)

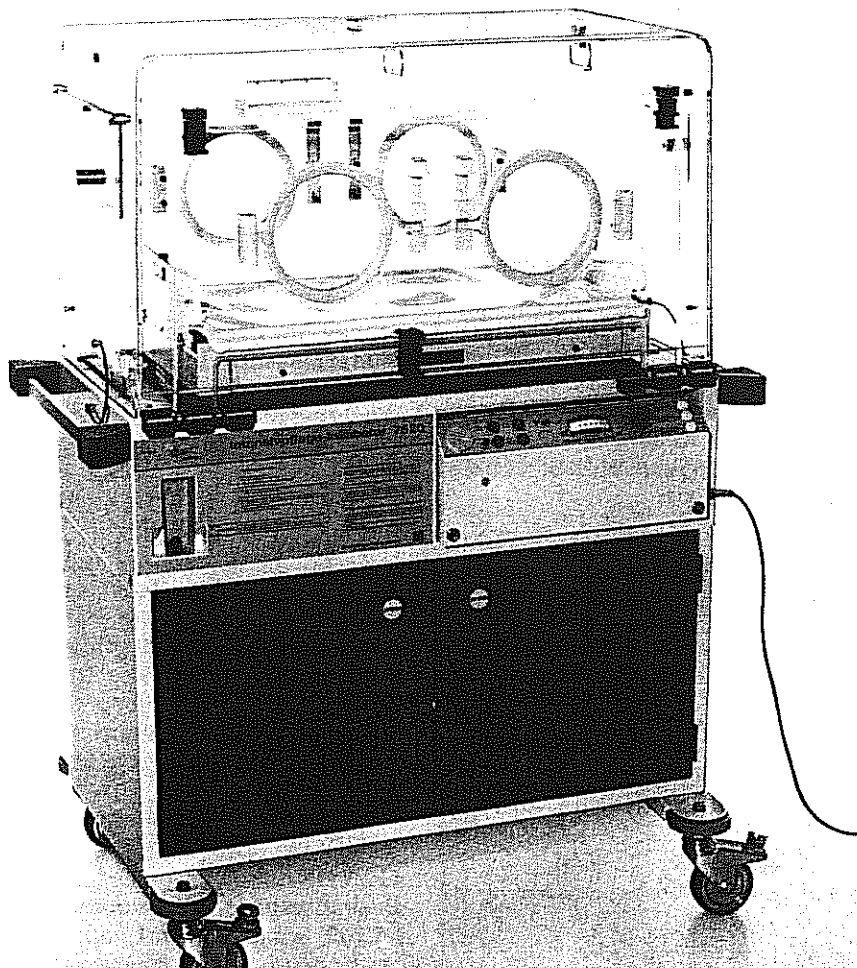

Fig. 1 b Intensive-care Incubator 7520 (with cabinet and unit 7022)

1 Intended Use

1.1 Incubator 7320

The Incubator 7320 (Fig. 1 a) is designed for premature and ill newborn babies. Warmth, humidified air, a higher concentration of oxygen and protection against infections all add up to an environment which ideally promotes the development of the baby.

Various items of supplementary apparatus can be connected, for instance, for secretion aspiration, for aerosol therapy and for infusions.

Its large front-opening hinged window makes the Incubator particularly suitable for the performance of phototherapy and for certain types of intensive-care treatment.

1.2 Intensive-care Incubator 7520

The Intensive-care Incubator 7520 (Fig. 1 b) is designed for infants aged up to 6 months whose lives are at risk and following surgery. Its main distinguishing features compared to the 7320 model are – a larger Plexiglass hood, hinged windows, a removable, swivelling support surface and an X-ray cassette drawer. Minor operations, radiology, intubation and ventilation of children can all be performed in the Intensive-care Incubator 7520 without difficulty.

2 Technical Data

Electrical data:
 Alternating current 50/60 Hz,
 Voltage as ordered:
 100, 110, 127, 220, 240 V,
 Connected load 300 W,
 Heating output 250 W
 Design: as per IEC Regulation 601 Part 1
 Classification: Type B 

Interior noise:
 Incubator 7320: 53 dB (A)
 Incubator 7520: 50 dB (A)

Weights: See order list, page 18/19

Dimensional drawings: See page 20

Test marks:
 The Incubators are interference-suppressed in accordance with VDE Regulation 0875 and bear the radio-protection mark. 



3 Design and Mode of Operation

The Incubator is mounted on a trolley or on a mobile cabinet and comprises the Incubator housing with electrical unit, the support surface for the child and a Plexiglass hood.

The air circulating system permits an adjustable, uniform Incubator temperature, control of the desired air humidity and oxygen concentration as well as effective protection against air-borne infections. The circulating air passes firstly over the sensors of the air-temperature regulator and of the safety thermostat and then over the heating element. The electric heating required to warm the Incubator air and the alarm functions are controlled by the air temperature measured at the sensors. Depending on the humidity setting, the air is then either routed over a surface of

water and thus humidified or some or all of the air is routed past this. Circulation means that the air temperature remains extremely even over the entire support surface. The ventilator also continuously draws in approximately 25 L fresh air per minute via two bacterial filters and mixes this with the circulating air. Oxygen can be added to the fresh air via a flowmeter, and this also passes through the bacterial filters. The addition of fresh air causes a slight positive pressure in the Incubator and this means that air flows through the gaps in the hood from inside to outside and the carbon dioxide exhaled by the child is thus flushed out.

A maximum CO₂ concentration of 0.12% develops in the Incubator, working on the assumption that the child generates 30 cm³/min CO₂.

3.1

Incubator units 7021/7022

The units contain all electrical operating and control equipment and are designed as replaceable slide-in modules. The difference between the units is that the 7022 is also equipped to permit skintemperature measurement and regulation.

3.1.1

Switch setting

»Disinfection in Dräger Aseptor«

In this setting the heating of the Incubator and the power failure alarm remain switched off. Only the ventilator is in operation.

3.1.2

Switch setting

»Air temperature regulation«

The pointer of the selector switch is moved to the desired Incubator air temperature – between 28°C and 37°C. Following heating-up of the Incubator, the proportional action controller automatically regulates the temperature to the desired level. Minimal deviations may occur between the display of the Incubator thermometer and the temperature set using the rotary knob. This can be attributed to the permissible variation of the equipment and the difference in measurement location between thermometer and sensor of the temperature regulator. The Incubator thermometer gives the definitive reading.

3.1.3

Skin temperature measurement (unit 7022 only)

In switch setting »Air temperature regulation« or »Skin temperature regulation«, the temperature of the child's skin is measured by a small temperature sensor affixed to the abdomen and is displayed on a measuring instrument.

3.1.4

Switch setting

»Skin temperature regulation« (unit 7022 only)

In the switch setting »skin temperature regulation« the skin temperature of the child is measured and adjusted to the set »desired value«. The Dräger skin temperature regulator operates on the basis of »flexible« proportional action control, the characteristic of which is illustrated in Fig. 4. The adjustment range for skin temperature is from 35°C to 37°C.

Example:

Desired value for skin temperature set to 36.1°C; actual value of measured skin temperature 36.3°C; hence deviation is 0.2°C.

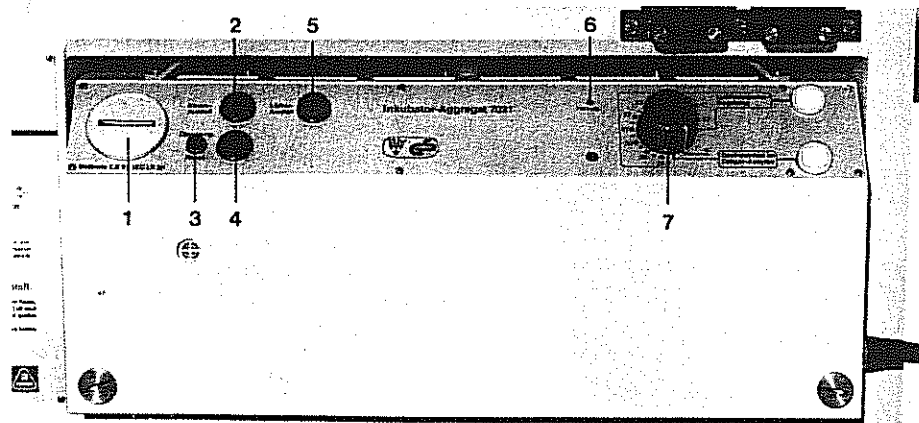

Fig. 2 Front panel of unit 7021

- | | |
|--|--|
| 1 Battery compartment for power failure alarm | 8 Test button and lamp for skin-temperature sensor alarm |
| 2 Test button and lamp for power failure alarm | 9 Adjusting screw for skin temperature desired value |
| 3 Test button for resetting the excess-temperature alarm | 10 Scale: skin temperature desired value |
| 4 Test button and lamp for excess-temperature alarm | 11 Scale: skin temperature actual value |
| 5 Test button and lamp for fan-failure alarm | 12 Pictograph: Important – use connection 13 for skin temperature sensor or test plug only |
| 6 Heating indicator lamp | 13 Connection for skin temperature sensor or test plug |
| 7 Mode switch | |

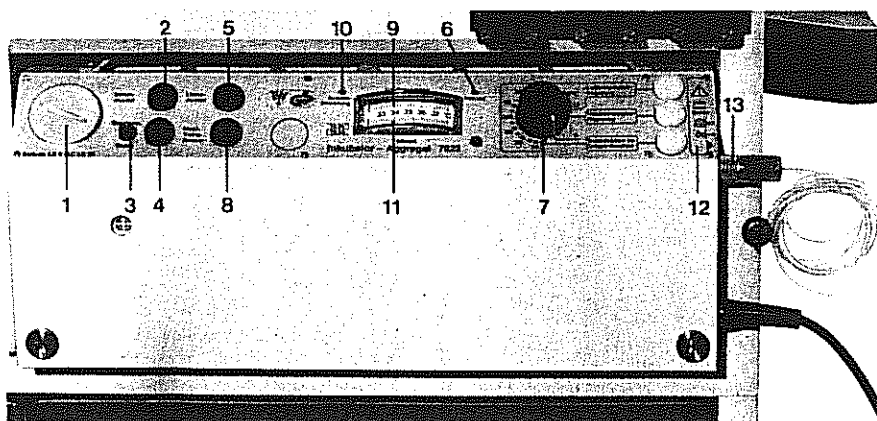

Fig. 3 Front panel of unit 7022 (with skin temperature regulation)

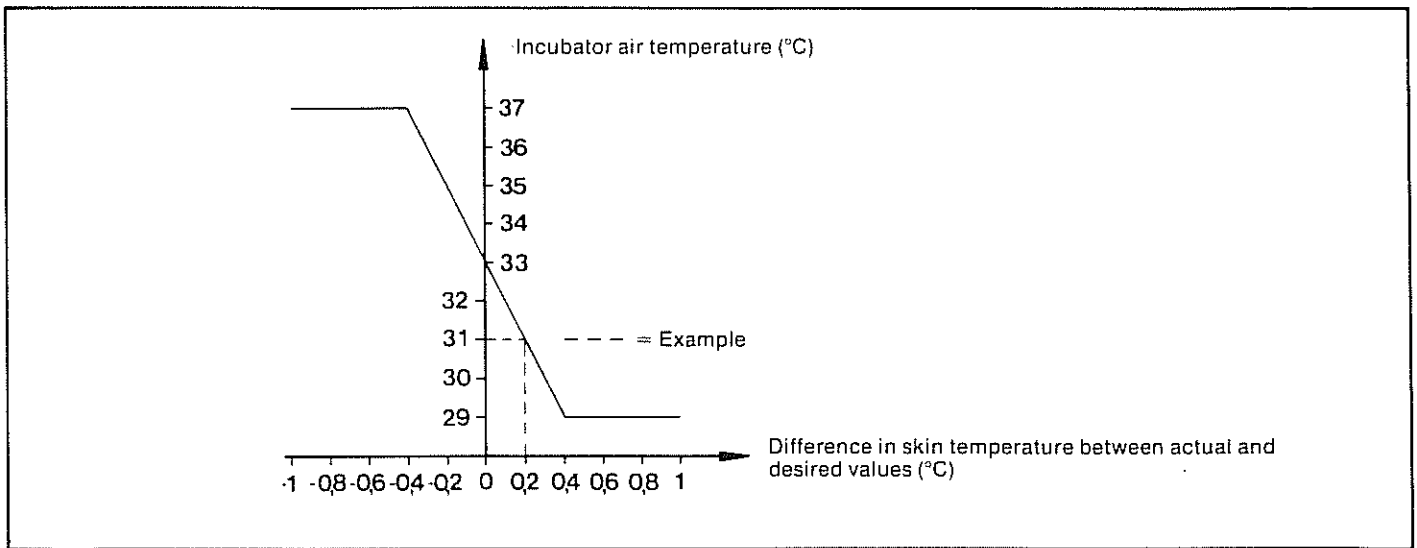

Fig. 4 Characteristic of skin temperature regulation

The consequence of this is – the Incubator air temperature is automatically regulated to 31°C.

Even with major deviations between actual and desired values for skin temperature the Incubator air temperature never drops below 29°C and never exceeds 37°C.

The advantage of the Dräger regulating system is that no major fluctuations occur in the air temperature inside the Incubator.

The degree of accuracy of skin temperature measurement and regulation is $\pm 0.25^\circ\text{C}$. The platinum resistor used as temperature sensor and the bridges and amplifiers – which are constructed from high-grade parts – are not subject to value fluctuations either as a result of differing ambient temperatures or due to aging over the course of time.

3.1.5

Alarm signals

All alarms take the form of audible and visual (lighting of appropriate red lamp) signals. The electric heating is switched off as appropriate to the nature of the alarm. The alarm function can be checked by pressing the appropriate warning lamp button. (Following checking of the excess-temperature alarm, press reset button.)

a) Power failure

The power failure alarm is ready for operation when the switch 7 is set to »Air temperature regulation« or »Skin temperature regulation«. In the event of an alarm the operating current is supplied by a 1.5 V battery.

b) Excess temperature

The alarm is given if the air temperature in the Incubator exceeds 39°C. Once the temperature has dropped below 39°C the alarm can be cancelled by pressing the reset button 3.

c) Fan failure

If air circulation in the Incubator is interrupted, an alarm is given.

d) Skin temperature sensor (unit 7022 only)

This alarm is given if, in the setting »Skin temperature regulation«, the plug of the skin temperature sensor is not inserted in connection 13 or if there is a wire break or short circuit in the sensor lead.

3.2

Fresh-air filter

The fresh air drawn in by the ventilator and the oxygen added pass through bacterial filters which have a degree of efficiency in excess of 99.97% before entering into the Incubator (Fig. 5).

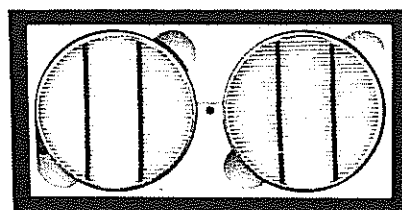

Fig. 5 Bacterial filters (accessible following removal of cover plate)

3.3

Humidification of Incubator air

Depending on the setting of the »Humidity« rotary knob, some or all of the air flowing into and circulating around the Incubator is routed over the surface of the water tank. Water constantly evaporates and this humidifies the air. The desired air humidity can be infinitely adjusted between 50 and 100 using the »Humidity« rotary knob (Fig. 6). This results in the following humidity settings:

At setting 50:
approximately 40 ... 60% relative humidity;

At setting 100:
approximately 80 ... 90% relative humidity;

The set humidity level remains virtually constant even given changes in interior temperature and oxygen supply. The relative humidity of the air in the Incubator should generally be between 60 and 80%.



Fig. 6 »Humidity« control

If use is made of high humidity and if the room temperature is considerably lower than the air temperature in the Incubator, the inner surfaces of the hood will mist up. If there is a minimal difference between ambient temperature and Incubator temperature, the hood will mist up to a lesser extent or not at all. The set high level of air humidity will still prevail in the Incubator nevertheless; this is best checked using a psychrometer (wet and dry bulb thermometer).

Slightly raise the upright grip whilst depressing the release button. Lower the support surface with the button depressed.

Upon special request the Intensive-care Incubator 7520 is also supplied with the more straightforward support surface as described in 3.4.1.

X-rays

Below the radioluscent plastic panel on which the child's mattress is supported there is a drawer into which an X-ray cassette can be inserted from outside (Fig. 13). A small flap in the hood merely has to be opened before pulling out the drawer.

3.4 Support surfaces

3.4.1 Support surface of Incubator 7320

The panel below the mattress can be raised at either end as desired and supported on the end walls of the support surface (head-up or head-down position) (Fig. 7). The support surface can also be inclined from outside the Plexiglas hood. Two supports (to be ordered separately) are used for this (Fig. 8). The shelf to the right of the support surface can be used to hold medicaments and instruments for brief periods while work is performed in the Incubator.

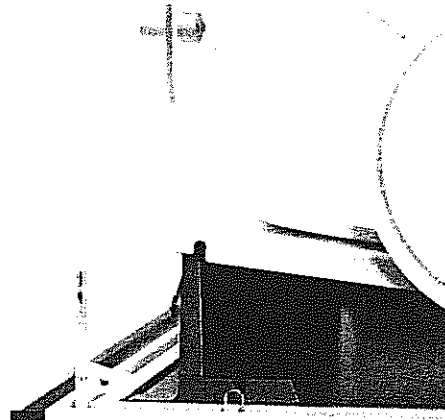

Fig. 7 Support surface of Incubator 7320, head-up position

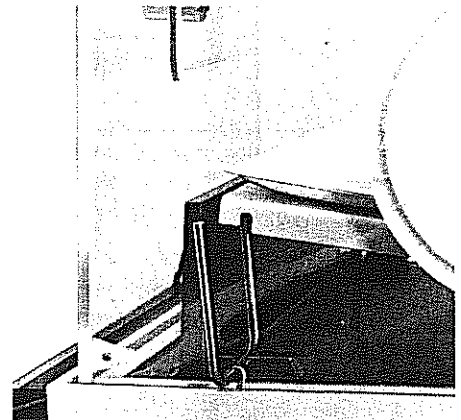

Fig. 8 Support surface of Incubator 7320, head-up position with support

3.4.2 Support surface of the Intensive-care Incubator 7520

Once the large Incubator flap has been opened, the support surface can be swivelled out on either side as desired (Fig. 9, 10) or drawn out straight (Fig. 11). This means that minor procedures such as intubation can readily be performed without having to remove the child from the Incubator. When the support surface is swung out, the head or foot board can be folded down (Figs. 9, 10) – the appropriate locking lever merely has to be pressed down for this.

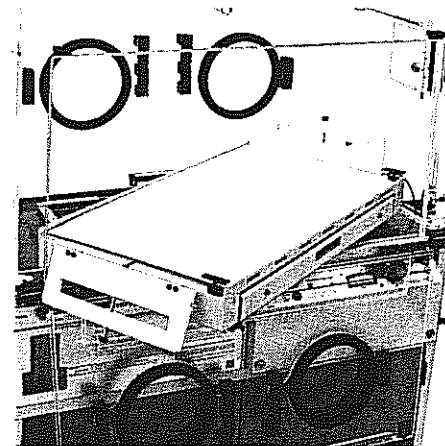

Fig. 9 Support surface of Incubator 7520 drawn out on left side, with head board folded down



Fig. 10 Support surface of Incubator 7520 drawn out to the right, with foot board folded down

Head-up or head-down position

The bed can be raised into three different positions at either end. To adjust the reclining angle, the side window is opened at the end of the bed to be raised. The bed is raised until it locks into the desired position (Fig. 12) using the grip on the head or foot board. Whilst doing this, the child can be securely held with the other hand through one of the front hand ports. The support surface is lowered back into its normal position in a similar manner.



Fig. 11 Support surface of Incubator 7520, pulled out straight

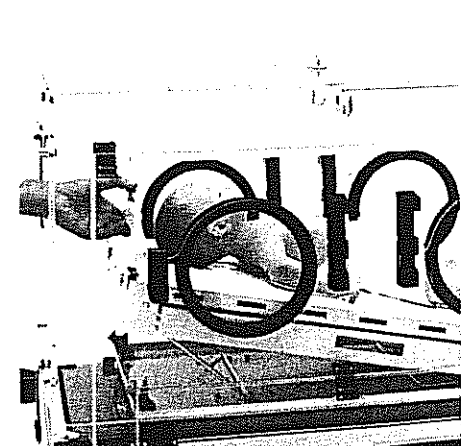

Fig. 12 Support surface of Incubator 7520, head-up position

3.5 Plexiglas hoods

3.5.1 Plexiglas hood of Incubator 7320 (Fig. 1 a)

In the front of the hood there is a large hinged panel which can be opened up. This facilitates performance of many therapeutic procedures during which the young patient can remain in the Incubator under the protection of the hood. The child can also be placed into and removed from the unit through the hinged flap.

It is even possible to perform phototherapy without interruption as the phototherapy unit does not have to be moved aside when the hinged flap is opened.

Four iris diaphragm hand ports provide access for routine manipulations and nursing. Upon special request swivelling windows can also be fitted instead of the iris diaphragms (see Fig. 14).

Two sliding windows at the ends of the Incubator permit simple and hygienic removal of dirty linen. Recesses in the openings of the sliding windows are designed to accommodate wide hoses, such as ventilation hoses. Other holes are used to pass through small hoses and cables.

3.5.2 Plexiglas hood of Intensive-care Incubator 7520 (Fig. 1 b)

There is again a large hinged flap in the front of the Plexiglas hood which can be opened up to place the child into or remove him from the Incubator together with the support surface (see 3.4.2). Take care to ensure that the large hinged flap is properly refastened again following opening and that the fasteners reengage securely.

A smaller hinged flap provides access to the X-ray drawer (see Fig. 13).

Four large hand ports with swivelling windows can be used to perform routine manipulations and nursing work. The windows silently spring open if slight pressure is applied to the catch with the elbow (Fig. 14). They can also be closed using the elbow. Upon special request iris diaphragms can also be fitted instead of the swivelling windows.

Ventilation hoses can be suspended on a moving rail below the hood and thus routed to the child from above (Fig. 15). The rail can be fitted on the right or left side of the hood as desired. There are numerous holes in the hood for passing through small hoses and cables.

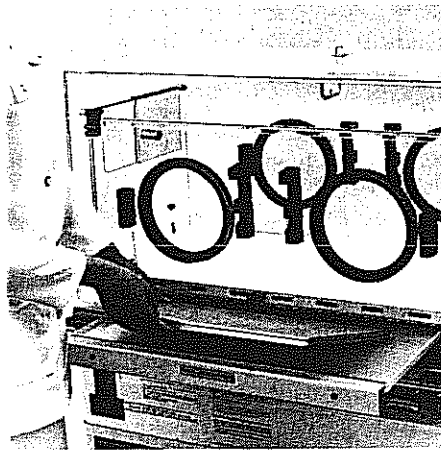

Fig. 13 Support surface of Incubator 7520, with X-ray drawer open

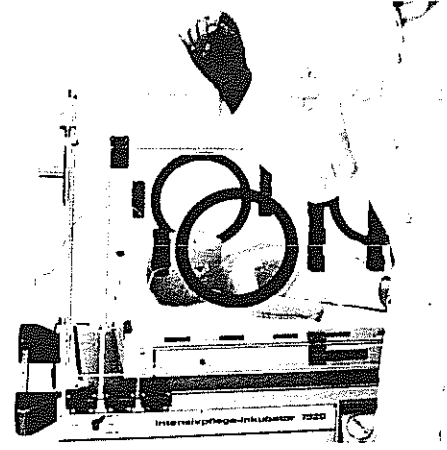

Fig. 14 Opening the swivelling windows

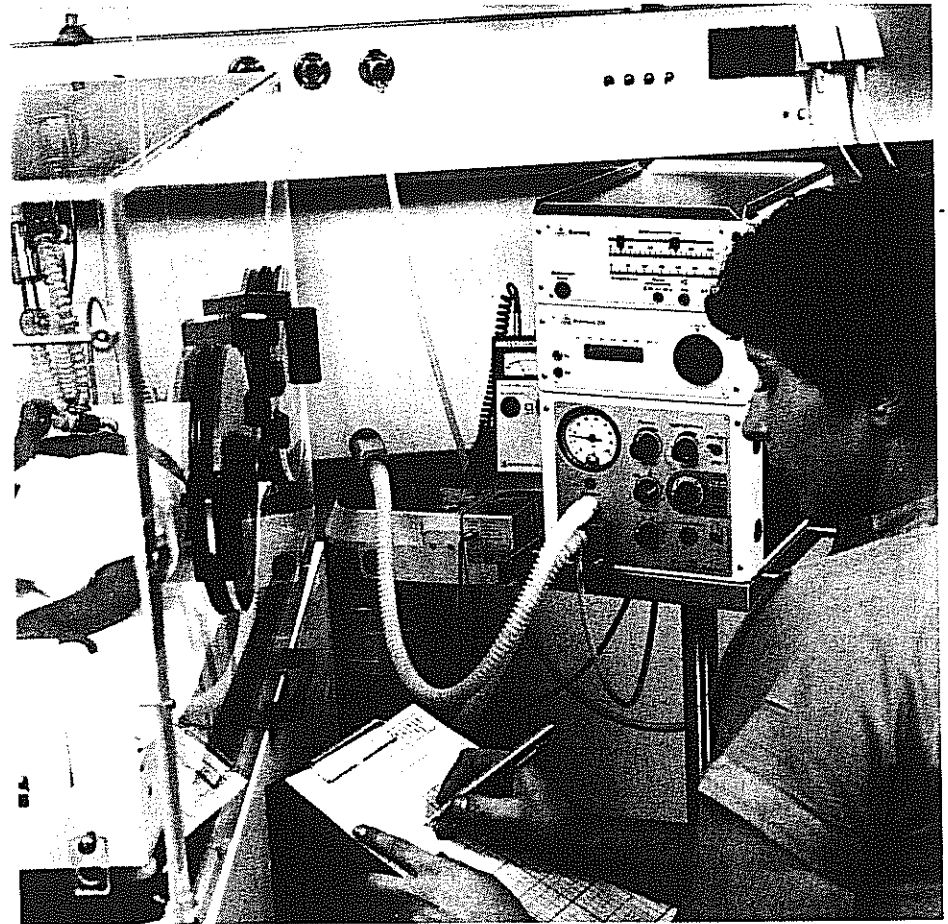

Fig. 15 Incubator 7520 with Babylog 1 and ventilation hoses entering the Incubator

3.5.3 Double wall system (Fig. 16, P. 8)

Function of the double wall system

A second wall inside the Incubator hood reduces the loss of heat by radiation from the child to the cool interior surfaces of the Incubator hood. The warmed air from the Incubator unit also

flows between the two walls which causes the interior wall to attain a temperature close to the air temperature in the Incubator (by way of comparison, the interior surfaces of the hood are on average approx. 3°C colder than the air temperature in the Incubator when there is no double wall system).

The child is surrounded by warm walls on the sides and at the top. This is particularly valuable in the case of premature babies weighing less than 1500 g as it guards against the risk of hypothermia as a result of heat loss by radiation. Further heat loss as a result of convection and evaporation has to be reduced by raising the air temperature and/or raising the degree of relative humidity.

Description

The double wall system is available for the Incubator hoods of models 7320 and 7520 – with supplementary fitting also being possible.

The interior wall system comprises two sections – an L-shaped section and a straight, flat pane, with the latter being attached to the large hinged flap.

Access to the child through the hand ports in the Incubator hood is not obstructed by the double wall system as the inner walls also feature large apertures in the same positions.

The inner walls can be fitted and removed rapidly and easily. The threaded bolts permanently fitted to the inner walls are pushed through holes in the Incubator hood and secured from outside with knurled nuts.

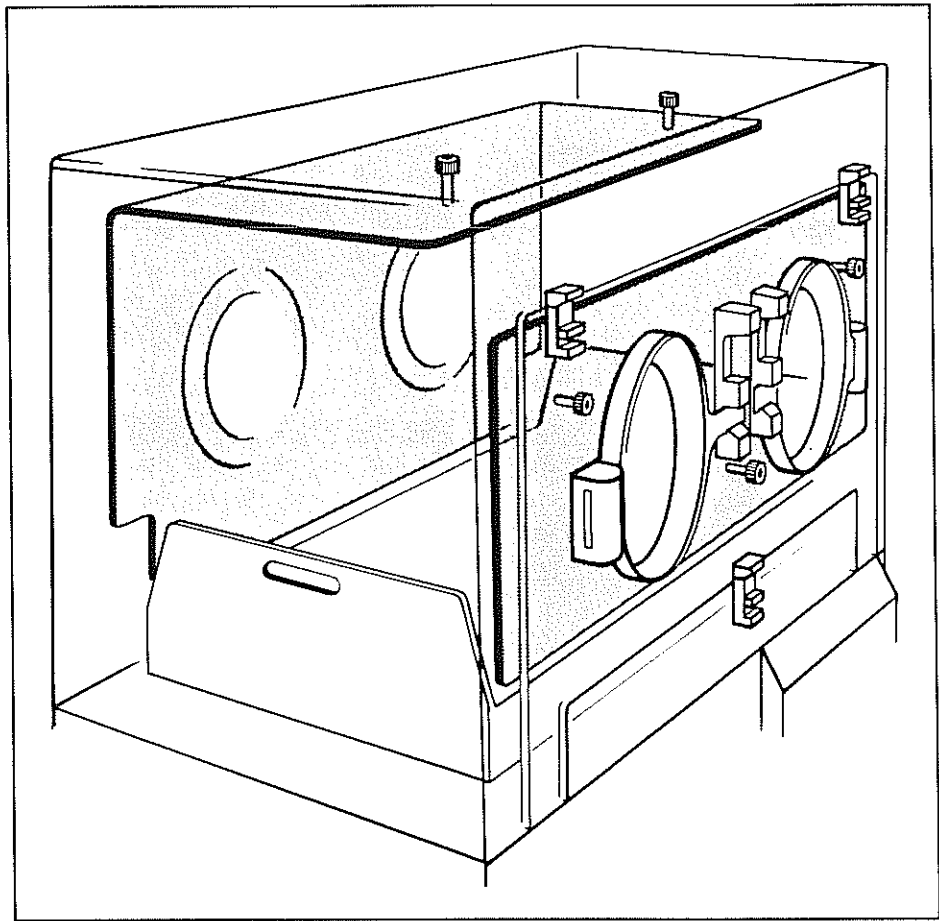

Fig. 16 Double wall system in the hood of Intensive-care Incubator 7520

Subsequent fitting

Holes have to be drilled in the Incubator hood to permit subsequent fitting of the double wall system. This work can best be performed by your local Dräger Branch or Agency.

3.6 Rails

One rail is located at each end of the Incubator for suspending various items of supplementary apparatus (Dräger rail system).

3.7 Trolley (see Fig. 1 a)

The trolley features a large shelf area which can hold accessories of a total weight of up to 20 kg. The two front castors (100 mm dia.) can be locked.

The trolley legs of Incubator 7320 are longer than those of Incubator 7520. This compensates for the difference in hood height between these units.

Located below the shelf are the eyes designed to hold the connecting lead and the O₂ connection hose if power and O₂ supply are on the left-hand Incubator side (see Fig. 17).

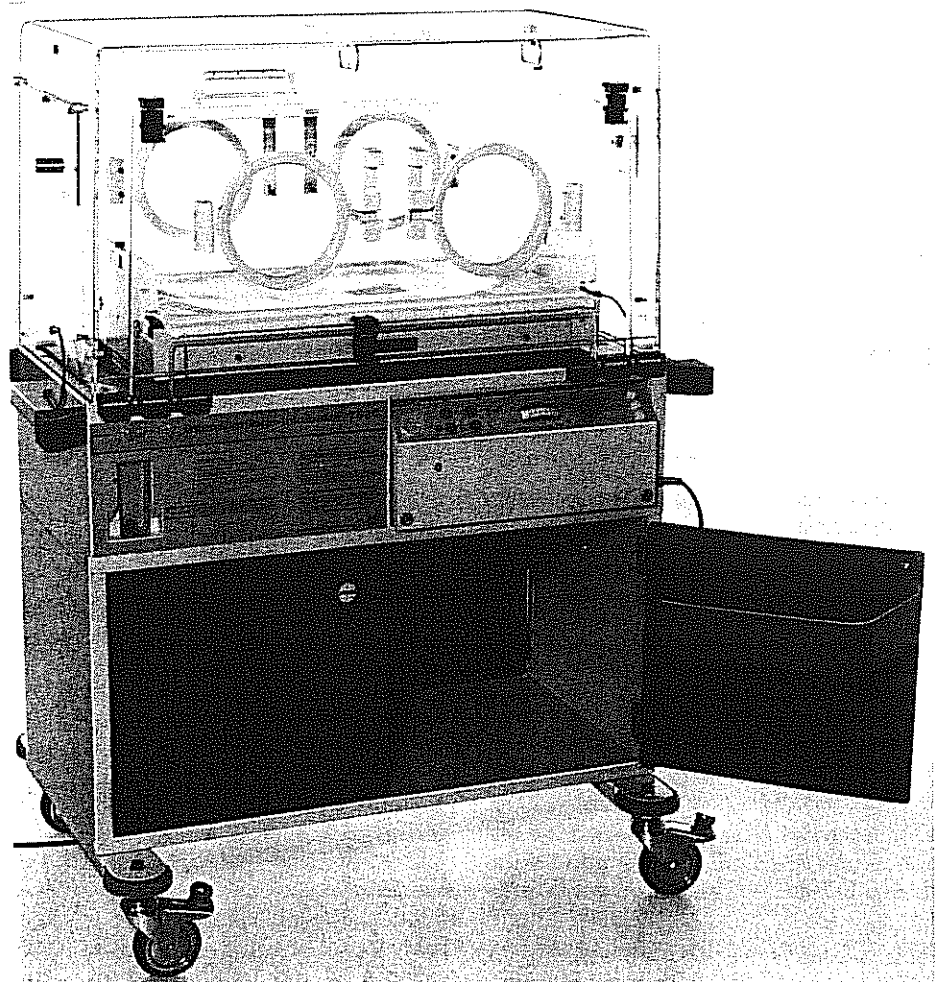

Fig. 17 Incubator cabinet with open door

Accessories

(on special order)

3.8.1

Cabinet (Figs. 1 b and 17)

The cabinet can be described as a trolley with doors on the front and back. The doors can be opened and closed by applying pressure (e. g. with the knee). All doors are fitted with large pockets which can hold medicaments etc. weighing up to max. 1 kg (Fig. 17). Larger items weighing up to 20 kg can be stored on the bottom of the cabinet.

The cabinet legs of Incubator 7320 are longer than those of Incubator 7520. This compensates for the difference in hood height between these units.

3.8.2

O₂ metering (Fig. 18)

The oxygen required to enrich the Incubator air is routed into the Incubator via a metering valve with flowmeter, a connection socket and a rubber hose.

The metering valve and flowmeter are attached to the Incubator rail (Fig. 18) by means of a clamp. It is not necessary to humidify the oxygen as this is ideally achieved inside the Incubator.

3.8.3

Oxygen limiter (Fig. 19)

An oxygen limiter can be connected to the Incubator. The oxygen limiter is screwed onto the bottom of the O₂ flowmeter (3.8.2) in place of the connection socket.

Two switch settings can be fixed at the handwheel of the limiter:

- a) White setting: even with a fully-open O₂ metering valve it is not possible for more than 6 L/min oxygen to flow into the Incubator. This corresponds to an oxygen concentration of approx. 40%.
If a lower O₂ content is required, a supply rate of less than 6 L/min is set at the metering valve.
- b) Red setting: no restriction of O₂ supply.

3.8.4

Oxygen helmet (Fig. 20)

A Plexiglas helmet is used to administer high concentrations of oxygen to the child as quickly as possible in the case of acute asphyxia. The oxygen is routed into the helmet via the O₂ metering valve (setting approx. 10 L/min), a humidifier/nebulizer and a corrugated hose.

If an extremely high O₂ concentration is desired a nappy must be wrapped around the child's neck to create a seal.

3.8.5

Water nebulizer (Fig. 21)

See relevant Operating Manual.

The water nebulizer permits humidification of the breathing air of the spontaneously breathing child with aerosols (average particle size 0.65 micron).

When using oxygen the O₂ concentration of the breathing gas can be infinitely adjusted between 40 and 100%. If no O₂ enrichment of the breathing gas is desired the nebulizer operates with compressed air.

Nebulizer heating is available to create the correct conditions in the humidified breathing gas from a physiological point of view, including the correct temperature. If the heating is used nebulizer performance simultaneously increases to two or three times the original level.

Nebulizer operation causes modifica-

tion of the O₂ concentrations shown in the Table in Section 5.3.

The O₂ concentration prevailing in the Incubator must be determined using an O₂ meter (see also the relevant notes in Section 5.3).

Nebulization of expectorant substances in the form of aqueous solutions.

These substances should only be applied in the Incubator with the water nebulizer in cases where the expected advantages clearly outweigh the drawbacks and hazards involved. It must be remembered that these substances will be deposited on all surfaces of the apparatus and that the residue has a strong tendency to develop fungus. Regular thorough cleaning of the Incubator is absolutely imperative in order to reduce the risk of infection for the child.

Please observe instructions for use of the substances employed.

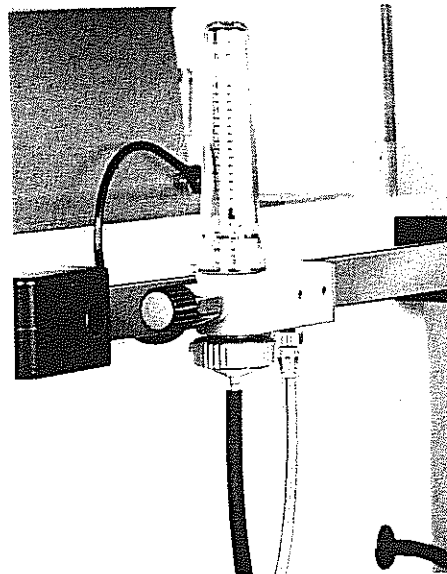

Fig. 18 O₂ flowmeter on Incubator rail

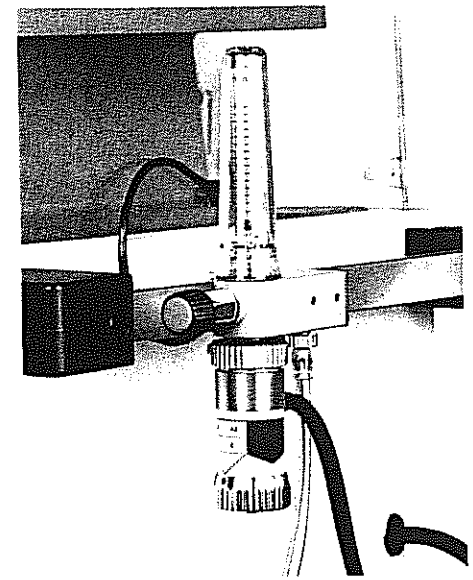

Fig. 19 O₂ flowmeter with O₂ limiter

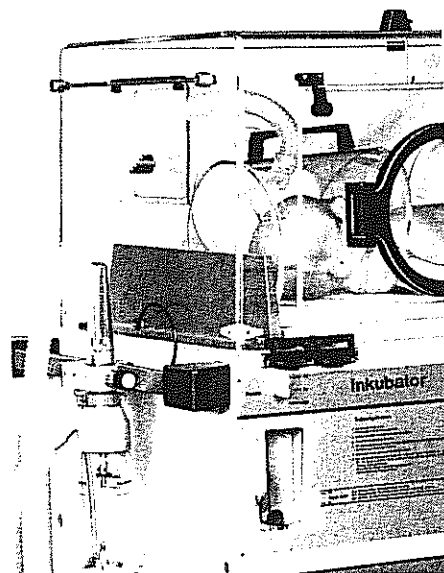

Fig. 20 Oxygen helmet

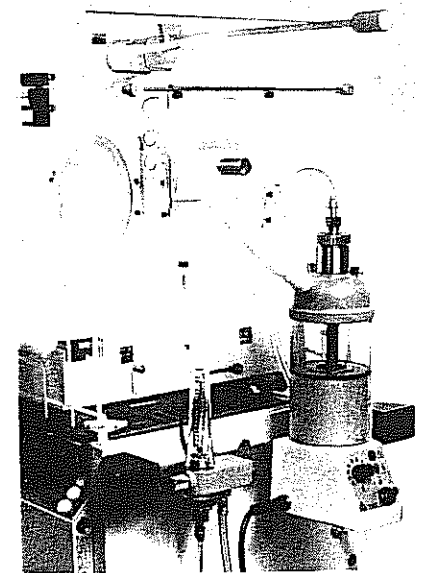

Fig. 21 Water nebulizer with heater

3.8.6

Oxygen distributor (Figs. 22, 23)

The oxygen distributor features 3 oxygen sockets which means that several items of apparatus using oxygen can be connected at the same time (e. g. ventilator, secretion aspirator and inhalation apparatus). The oxygen distributor is attached to one of the Incubator rails.

Two versions of the oxygen distributor are available:

- a) Oxygen distributor without O₂ cylinder (for O₂ supply from a central supply unit).
- b) Oxygen distributor battery with bracket for 3 L oxygen cylinder, with pressure reducer and O₂ connection hose.

With this version oxygen is supplied either from an O₂ cylinder or from a central supply unit as desired, depending on whether the connector of the O₂ connection hose is plugged into the socket supplied by the O₂ cylinder or into the wall outlet.

3.8.7

Infusion stand (Fig. 24)

The height-adjustable infusion stand can be screwed to the Incubator rail.

3.8.8

Small operating-theatre lamp (Fig. 25)

The small operating-theatre lamp provides a sharp, concentrated field of cold, colour-corrected light for performing diagnosis and minor operations on the child. The lamp is secured to an Incubator rail using a special holder which is to be ordered separately. The fitting rotates and swivels, thus permitting illumination of every point inside the Incubator.

Replacing the bulb:

There are two screws on the outer circumference of the lamp unit. These are to be removed using a screwdriver. The entire filter element is then removed. The bulb is now accessible and can be detached by pressing it backwards and turning to the left (bayonet socket). Attention must be paid to the following when fitting the bulb – the rubber O-ring behind the chromium ring of the filter element must make contact with the Plexiglas lens. The filter element can only be introduced into the lamp unit in one position.

Technical data:

Mains voltage: 220 V

Power consumption: 50 W

Illumination: approx. 3000 lux

3.8.9

Phototherapy unit (Fig. 26)

The aim of the irradiation of newborn

and premature babies with light is to lower a high serum bilirubin concentration or to preclude a critical rise in the level. In mild cases this obviates the need for an exchange of blood. See relevant Operating Manual.

3.8.10

Bronchial aspirator (Fig. 27)

The integral ejector generates a variable vacuum. Secretion can be removed from the baby's airways using a thin catheter. The rinsing jar is used to rinse the catheter with water or rinsing fluid.

The apparatus operates with oxygen or compressed air. See relevant Operating Manual.

3.8.11

Vacuum mattress (Fig. 28)

The vacuum mattress is filled with small foam pellets. Once the air has been extracted from inside the normally flexible mattress becomes „stiff“. Before doing so, it can be put into certain positions and these are retained following extraction of the air. This is an excellent way of ensuring that even extreme positions, which may be required following operations on the baby (e. g. atresia of the oesophagus), can be achieved. The whole child or just the arms and legs can be held securely and comfortably in position as required for infusions or X-rays, for example.

The easiest way of evacuating air until the required degree of mattress hardness is achieved is by using a suction device. During air evacuation the mattress valve must be open (turn hose socket in anti-clockwise direction).

Upon attainment of the desired „hardness“ close the mattress valve (turn hose socket in clockwise direction).

3.8.12

Securing straps (Fig. 29)

There are slots in the side walls of the mattress of the Intensive-care Incubator and these can be used to secure the baby. Upon special order padded securing straps, 2M 13898, with velcro fasteners will be supplied. These are highly suitable for securing the arms and legs of the child.

3.8.13

Baby scale (Fig. 30)

Minor conversion of the hood has to be performed to use the scale with the Incubator:

The transparent cover on the top of the hood is removed and replaced by the

scale holder. The flange of the scale hook seals the large open hole in the top of the hood.

The scale can now easily be fitted in the holder on the Incubator hood and can thus be used on all Dräger Incubators in the ward.

To weigh the child, he is placed in a weighing sheet which is fastened onto the weighing hook. The weight of the child is established by moving the sliding weights.

The scale is calibrated in accordance with the German Standard (Eichordnung – EO) and is approved for use as a baby scale in Germany. The measuring range is 7.5 kg.

3.8.14

Oddments tray (Fig. 31)

The stainless steel tray is attached to the Incubator rail. Its dimensions are as follows: width 30 cm, depth 20 cm.

The maximum weight of accessories which may be placed on this tray is 3 kg.

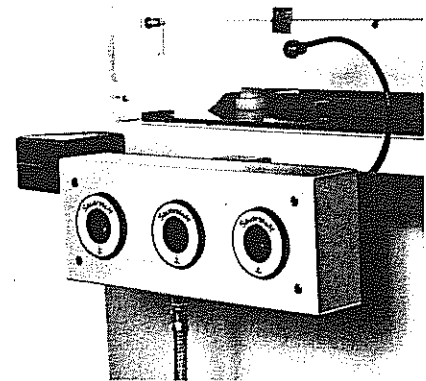

Fig. 22 Oxygen distributor

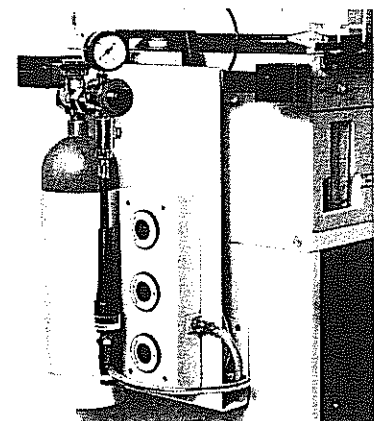

Fig. 23 Oxygen distributor with cylinder connection

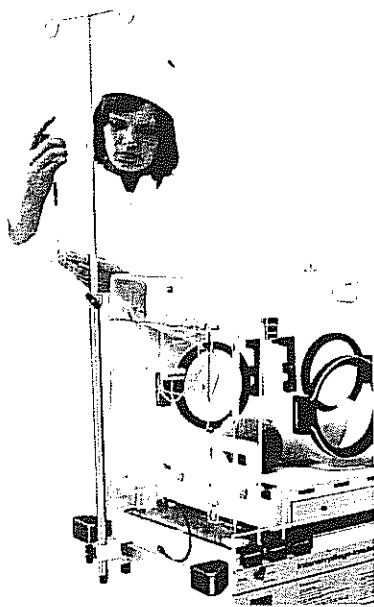

Fig. 24 Infusion stand

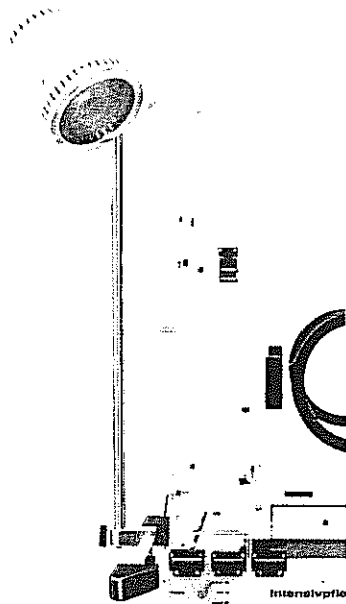

Fig. 25 Small operating-theatre lamp

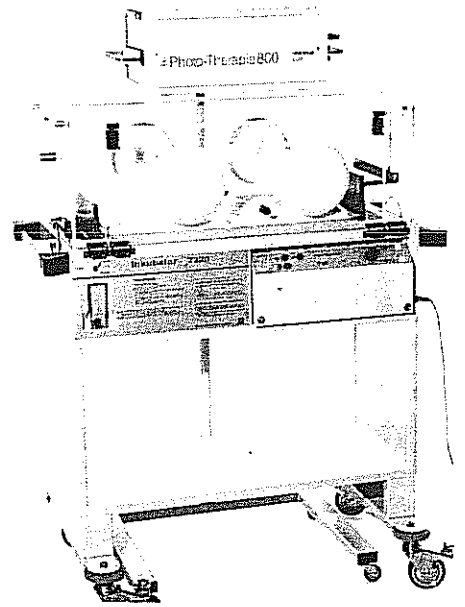

Fig. 26 Incubator with phototherapy unit

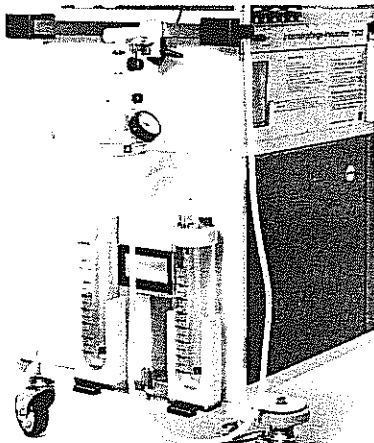

Fig. 27 Bronchial aspirator

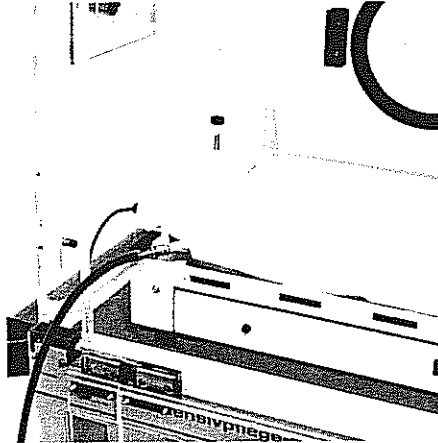

Fig. 28 Vacuum mattress



Fig. 29 Fastening the securing straps

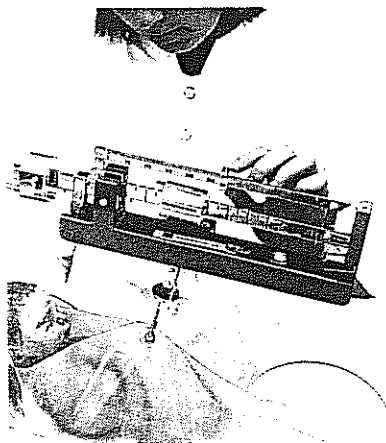

Fig. 30 Sliding-weight baby scale

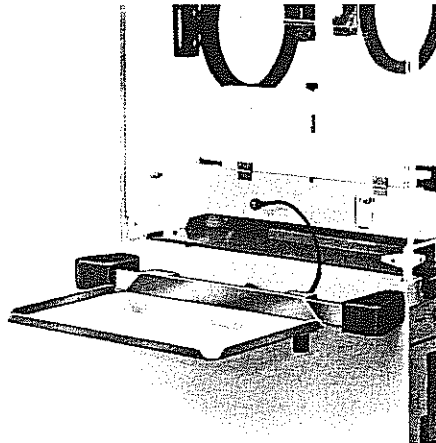

Fig. 31 Oddments tray

4 Initial Preparation

4.1 Unpacking and setting-up

When unpacking the apparatus the packing material must also be removed from inside. To do this, lift up the brown covering plate.

Fitting the Plexiglas hood:

Place hood on Incubator and engage the hinges by applying slight pressure from above.

Unfasten the screws of the bottom hinge sections (on Incubator), place the locking plates provided over the bottom hinge sections and refit screws (Fig. 32).

The large front Plexiglas flap is fitted in the same way as described above.

Securing the Plexiglas hood:

Clip the side retaining cords to the hood.

4.2 Cleaning, functional testing and test run

Section 7. Care and Servicing, contains detailed information on cleaning, disinfection, assembly and testing of the apparatus for operational readiness. This work should also be performed prior to initial commissioning.

Before connecting the apparatus, check that the mains voltage corresponds to that given on the rating plate of the Incubator.

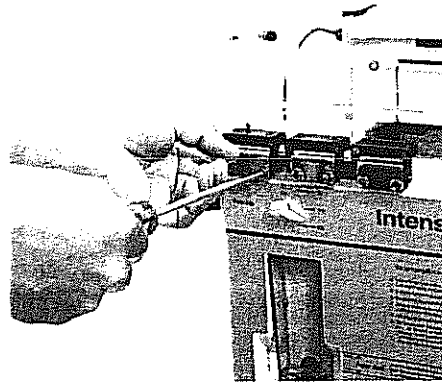

Fig. 32 Securely screw hinges and locking plate to the Incubator.

4.3 Humidification of Incubator air

Fill the water container with distilled water. To do so, pull water gauge forwards (Fig. 33).

The water level should always be kept between the min. and max. marks.

In order to prevent bacterial growth in the water container, a silver compound should be added to the water every time the container is refilled. We recommend using 4 Micropur tablets MBT 1 or 1 cm³ liquid Micropur (manufactured by Deutsche Katadyn-Gesellschaft mbH, 8000 Munich 21, Schäufeleinstr. 20. West Germany).

Before they can be placed in the water container the Micropur tablets must be dissolved in distilled water. (Important: silver compounds must never be added to the water supply of aerosol nebulizers.) Set desired humidity at the »Humidity« lever (Fig. 6).

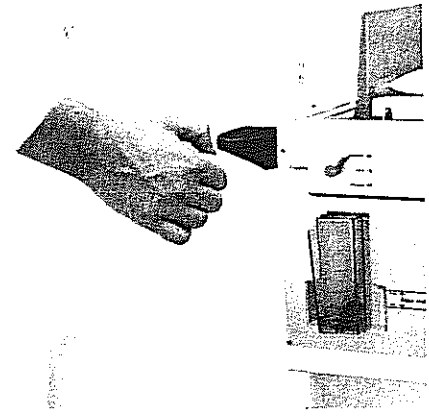

Fig. 33 Filling the water container

4.4 Heating-up the Incubator

Set the desired Incubator temperature using the selector switch (»Air-temperature regulation« lamp lights).

If the room temperature is 12°C below the set temperature, the following heating-up times are to be expected:

	Humidity 50	Humidity 100
Incubator 7320	approx. 30 min.	approx. 50 min.
Intensive-care Incubator 7520	approx. 35 min.	approx. 85 min.

Following completion of the heating-up phase the Incubator temperature is kept constant (»Heating« lamp flashes intermittently when actual value = desired value). Check temperature at Incubator thermometer.

5 Operational Use

5.1 Air-temperature regulation (see also 3.1.2, Page 4)

The Incubator is warmed as described in 4.4 and the child is placed inside. The child's temperature must be taken at regular intervals and the set incubator air temperature should be corrected if necessary.

5.2 Skin-temperature regulation (see also 3.1.4, Page 4)

With Incubator 7022 it is possible to regulate either the air temperature or skin temperature.

There are advantages to be gained from skin-temperature regulation rather than the air-temperature regulation generally performed in the Incubator given the following indications:

- Underdeveloped premature baby with temperature regulation disorders
- Children with severely impaired health and temperature regulation disorders

Important: Skin-temperature regulation must **not** be used on babies in a state of shock.

The skin temperature of these babies is well below the interior temperature of the body and the children would suffer overheating if skin-temperature regulation were to be employed.

In such cases use must be made of air-temperature regulation.

Procedure for skin-temperature regulation

The Incubator is warmed as described in 4.4 and the child is placed inside. The plug of the skin-temperature sensor is inserted in connection 13 on the side of the unit and is securely tightened using the locking nut (Fig. 3).

The sensor is passed into the interior through the hole in the right end face of the Incubator hood.

Secure the sensor between the baby's navel and breastbone using the adhesive rings supplied (Fig. 3+).

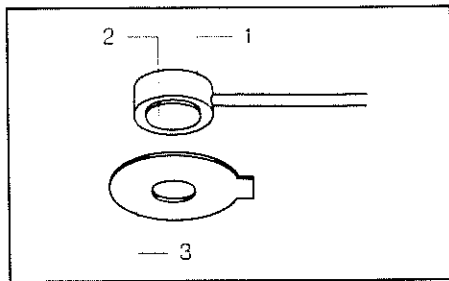

Fig. 34 Securing the skin-temperature sensor
 1 Sensor
 2 Metallic measurement surface
 3 Adhesive ring

Turn the selector switch on the Incubator unit to »Skin-temperature regulation« setting (»Skin-temperature regulation« lamp lights).

The skin temperature measured is displayed by the lower pointer (actual value) of the instrument. The desired skin temperature (desired value) is set at the screw labelled »desired value setting« using the screwdriver supplied. The desired value can be set between 35°C and 37°C – it is indicated by the top pointer of the instrument.

The regulator attempts to adjust the baby's skin temperature to the pre-selected desired value by raising or lowering the air temperature in the Incubator to compensate for the deviation of the skin temperature from the desired value. Even given major deviations from the desired value the air temperature in the Incubator will never to drop below 29°C or exceed 37°C.

Practical experience shows that the skin temperature of the child often changes rapidly, for instance during feeding, when the baby is being handled, when the child is going asleep or waking up etc. Although the regulating system of the Incubator reacts immediately to any disorder, by raising or lowering the air temperature in the unit, it takes longer for the skin temperature of the child to be restored to the desired value. This means that deviations of a few tenths of a degree between the set desired value and the skin temperature displayed may occur at any time and are to be considered normal.

Regular checks must be made to ensure that the temperature sensor is properly secured to the child.

Unintentional removal of the sensor from the child's skin would mean that the regulator would no longer keep the skin temperature at the desired value but would rather react to the temperature of the cooler mattress or whatever else it may be touching. This would cause the air temperature in the Incubator to rise to a higher level than is required by the baby, although a temperature of 37°C would never be exceeded.

5.3 Oxygen administration (see also 3.8.2 to 3.8.4)

The oxygen supply is set at the metering valve of the flowmeter (Fig. 18) on the basis of the approximate values given in the Table (see Page 13). The oxygen supply rate can be read off from the top edge of the ball.

The oxygen concentration in the Incubator must be measured at regular intervals using an oxygen meter (e. g. »Oxydig« from Dräger). This is the only way of guaranteeing that operating errors and other sources of error are detected with sufficient reliability.

A holder which can be attached to the Incubator rail is available for continuous oxygen measurement with the »Oxydig« (Fig. 35).

A seal is fitted to the sensor of the measuring device for intermittent O₂ measurement; this is used to press the sensor against one of the holes in the Plexiglas hood of the Incubator (Fig. 36).

Oxygen enrichment of the Incubator air may only be performed under the instruction of qualified medical personnel. It must be controlled on the basis of the arterial measurement of oxygen partial pressure in the baby's blood. This is the only way of guarding against hyperoxaemia, which would damage the eyes, and hypoxaemia which would damage the brain.

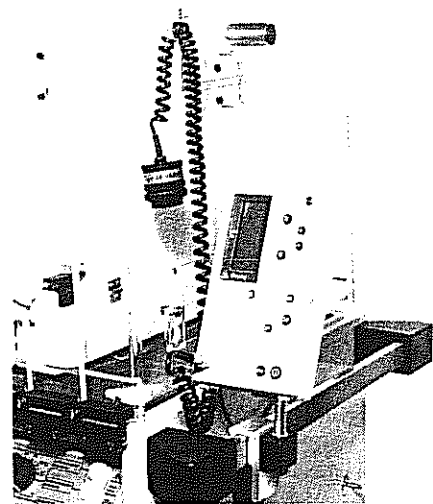

Fig. 35 Continuous O₂ measurement

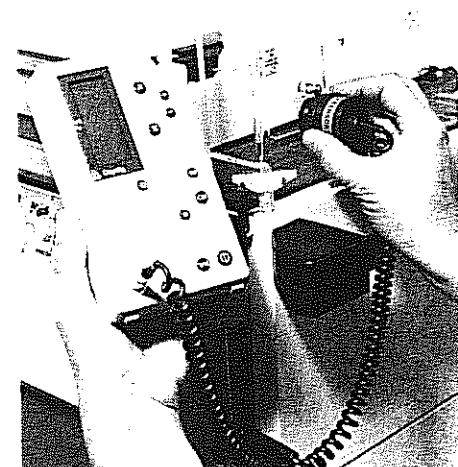

Fig. 36 Intermittent O₂ measurement

O ₂ concentration [%]	25	30	35	40	45	50	55	60	65
O ₂ supply rate [L/min]	1.5	3	4.5	6	7.5	9	11	12.5	14

5.4 Precautionary measures

Monitoring of breathing-gas temperature

The temperature of the breathing gas of ventilated or CPAP patients has to be monitored as the breathing-gas hoses may be warmed up unduly by the heated, circulating Incubator air.

External heat sources

Direct sunlight or other heat sources may lead to a dangerous rise in Incubator temperature. Phototherapy produces an additional supply of heat for the child. If applicable, reduce the set Incubator temperature value.

Increased fire risk when using oxygen

1 All potential fire risks such as matches, burning cigarettes and the like must be kept out of the room in

which the Incubator is set up. Fabrics, oils and other combustible materials become highly inflammable and burn with great intensity in air which is enriched with oxygen.

- 2 It is imperative that oxygen valves, fittings and seals are kept free of oil and grease. Open valves slowly.
- 3 Do not use the Incubator in the presence of flammable anaesthetic gases.
- 4 No electrical equipment, with the exception of »intrinsically safe« units, may be placed under the Plexiglas hood of the Incubator. Flammable liquids, such as alcohol or ether, must not be used or stored in the Incubator.

Protection against the risk of electric shocks

It must be ensured, beyond doubt, that any other apparatus connected to the baby is »electrically safe«.

6 Trouble Shooting

Fault	Possible cause	Remedy
<p>»Power failure« test button depressed – buzzer does not sound</p> <p>Warning lamp does not light</p>	<p>Battery position incorrect Battery flat Battery contacts corroded Selector switch in »off« setting or »Disinfection in Dräger Aseptor« setting</p> <p>Alarm function defective Bulb defective</p>	<p>Turn positive terminal of battery to top Replace battery (use only leak-proof batteries). Clean contacts Selector switch to »air-temperature regulation« or »skin-temperature regulation« setting Contact nearest Dräger Branch/Agency Contact nearest Dräger Branch/Agency</p>
<p>Power failure alarm: buzzer sounds, warning lamp lights</p>	<p>Mains plug pulled out. Power supply failure</p>	<p>Plug in Check fuse</p>
<p>»Excess temperature« test button depressed:</p> <p>Buzzer does not sound, lamp does not light</p>	<p>Selector switch in »off« setting</p> <p>Bulb defective, alarm function defective</p>	<p>Put selector switch into »air-temperature regulation« or »skin-temperature regulation« setting Contact nearest Dräger Branch/Agency</p>
<p>Red »excess temperature« warning lamp lights, buzzer sounds</p>	<p>Previously triggered alarm or alarm test not yet cancelled Heating of Incubator from outside: sunlight, radiator close by Defective temperature regulator: the incubator temperature rises above set value.</p>	<p>Depress reset button</p> <p>Move incubator to different location, following cooling depress reset button Shut down apparatus and contact nearest Dräger Branch/Agency</p>
<p>»Fan failure« test button depressed: buzzer does not sound, lamp does not light</p>	<p>Selector switch in »off« setting</p> <p>Bulb defective, alarm function defective.</p>	<p>Put selector switch into »air-temperature regulation« or »skin-temperature regulation« setting. Contact nearest Dräger Branch/Agency</p>
<p>»fan failure« warning lamp lights, buzzer sounds</p>	<p>Fan impeller missing or not correctly attached Motor defective</p>	<p>Fit and securely attach fan impeller Shut down apparatus and contact nearest Dräger Branch/Agency.</p>
<p>Incubator does not attain preset temperature</p>	<p>Excessive external cooling: Incubator standing in draught Room too cold Hand ports open Brown covering plate fitted incorrectly</p>	<p>Eliminate draught. Increase room temperature Close hand ports Fit covering plate correctly</p>
<p>For skin-temperature regulation only: »Skin-temperature sensor« test button depressed: Buzzer does not sound, lamp does not light</p>	<p>Selector switch in »off«, »Aseptor« or »air-temperature regulation« setting. Bulb defective, alarm function defective</p>	<p>Put selector switch into »skin-temperature regulation« setting. Contact nearest Dräger Branch/Agency.</p>
<p>Red »skin-temperature sensor« warning lamp lights, buzzer sounds</p>	<p>Skin-temperature sensor not properly connected Sensor defective (wire break or short circuit)</p>	<p>Plug in sensor cable and tighten lock nut. Connect replacement sensor.</p> <p>Switch over to »air-temperature regulation« until fault has been remedied.</p>
<p>Skin-temperature display shows minimum</p>	<p>Sensor still too cold</p>	<p>Wait for sensor to heat up</p>
<p>Skin-temperature display too low</p>	<p>Sensor not properly secured to child</p>	<p>Correctly secure sensor</p>
<p>No regulation of skin temperature</p>	<p>Selector switch not in »skin-temperature regulation« setting</p>	<p>Set selector switch to »skin-temperature regulation«</p>
<p>Water level is below the bottom marker of the sight glass or is not visible:</p>	<p>Too little water in water container</p>	<p>Top up with distilled water</p>
<p>Oxygen concentration too high when adjusted in accordance with Table on P. 13 (can be determined using oxygen meter)</p>	<p>Interrupted or impaired supply of fresh air: Fan impeller not properly secured Motor defective</p> <p>Bacterial filters clogged</p>	<p>Fit and secure fan impeller correctly Shut down apparatus and contact nearest Dräger Branch/Agency Replace bacterial filters</p>
<p>Oxygen concentration too low when set according to Table</p>	<p>»Wrong« air flowing into Incubator: Hand port open, flap open Seals between base unit and interior of Incubator not O.K.</p> <p>Screws of unit loose</p>	<p>Close openings Following removal of unit, refit seal or contact nearest Dräger Branch/Agency Tighten up securing screws of the unit</p>
<p>No oxygen flow</p>	<p>Metering valve or oxygen cylinder valve not open Oxygen cylinder, oxygen supply unit empty Oxygen connecting hoses not connected</p>	<p>Open valves</p> <p>Provide new supply of oxygen</p> <p>Connect hoses</p>

7 Care and Servicing

7.1 Care following use

At least once weekly and every time a new baby is placed in the Incubator, it must be dismantled, cleaned, disinfected and reassembled and checked for readiness for operation in a «clean room». The Dräger »Equipment Maintenance Centre« is available for this purpose.

7.1.1 Dismantling

Switch off apparatus and unplug at mains. Accessories, such as secretion aspirators should be removed and dismantled. All fluid containers should be emptied.

Water-absorbing items such as nappies, foam etc. should be removed from the incubator.

Mattress and support surface are removed from the apparatus.

Before raising the cover plate (Fig. 37) ensure that the apparatus really has been unplugged at the mains – the fan impeller can be dangerous if still moving.

Allow the heating to cool down before touching.

If applicable, remove the inner wall from the double Plexiglas hood after unfastening the knurled nuts.

Drain off the water from its container. To do this, pull the water gauge forward and tilt (Fig. 38). In the cabinet version the door below the water gauge should be opened to place the collector in the trolley. It is however also possible to turn the water gauge such that it tilts outwards on the left-hand Incubator side, with the collector now being held away from the cabinet below the water gauge.

Then completely pull out the tilted water gauge. Any droplets of water still emerging can be wiped off with a cloth.

Remove the water insert (Fig. 39).

The fan impeller can be removed once the air duct has been opened up. To do so, hold this with the left hand and turn the knurled nut anti-clockwise through half a turn using the right hand (Fig. 40).

The two bacterial filters can be removed once the panel has been removed from the back of the apparatus (Fig. 41).

7.1.2 Cleaning

The dismantled apparatus parts and the Incubator, including the interior, are cleaned of soiling using a damp cloth soaked in a rinsing agent (wetting agent)¹⁾ (Fig. 42).

The connecting hole between the water container and water gauge is cleaned using a bottle brush.

Once the apparatus and parts have been cleaned in this manner allow them to dry.

¹⁾ Please observe the compatibility list for Plexiglas 2M 8016 provided.

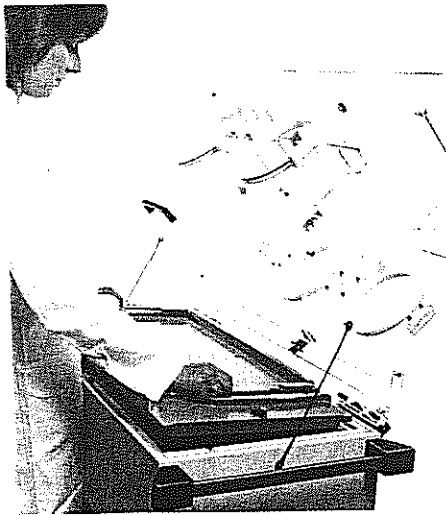

Fig. 37 Lifting off the cover plate

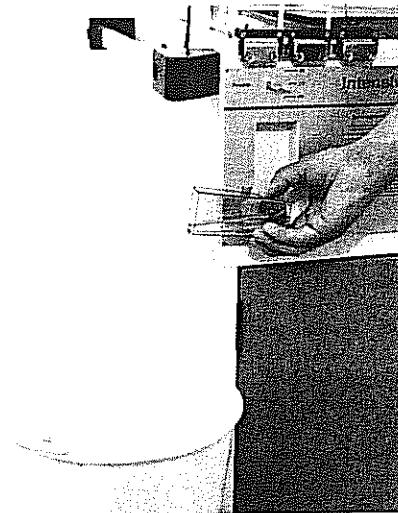

Fig. 38 Draining water out of the incubator

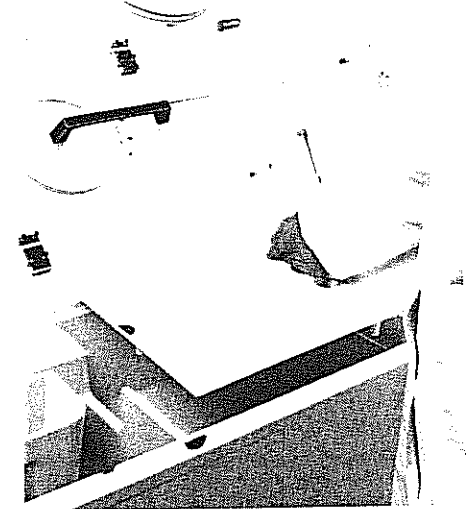

Fig. 39 Removing the water insert

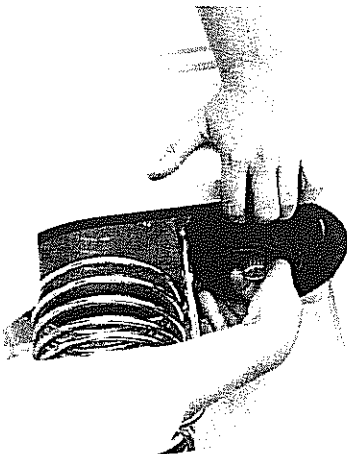

Fig. 40 Removing the fan impeller

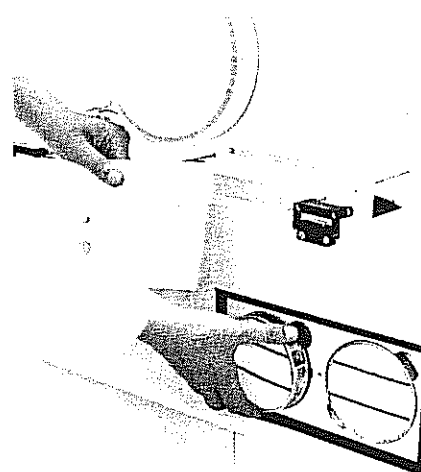

Fig. 41 Removing the bacterial filters

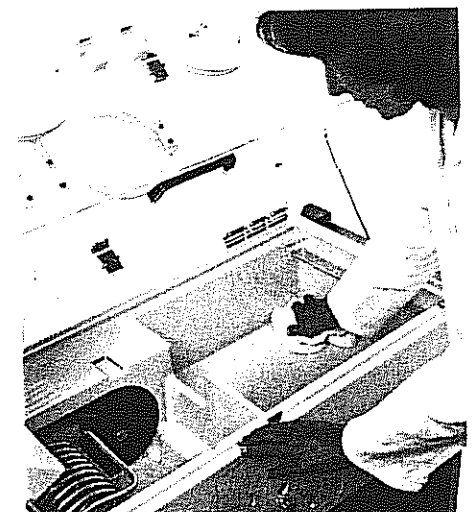

Fig. 42 Wiping the Incubator

7.1.3

Disinfection

It is advisable to disinfect the apparatus by way of wipe disinfection (please see relevant documentation on formaldehyde).

The apparatus is to be prepared for disinfection as described in the Section on «Cleaning». We recommend placing incidentals and component parts of accessories in a disinfectant solution. Following disinfection the parts must be thoroughly rinsed with water and then dried.

Wipe over the Incubator and all accessories with a disinfectant solution. Please consult official documentation on disinfection procedures and their effectiveness.

The compatibility list 2M 8016 supplied provides information on the compatibility of some of the disinfectants mentioned with the material of the Incubator.

If disinfection is to be performed in the Aseptor, please proceed as follows:

Prepare the apparatus for disinfection as described in 7.1.2 «Cleaning».

The apparatus and incidentals must be dry as otherwise unpleasant odours may occur following disinfection. Prior to disinfection in the Aseptor, the Incubator must be shut down and cooled to room temperature, as otherwise efficient condensation cannot be achieved and the effectiveness of disinfection is not guaranteed. The Incubator is placed in the Aseptor in the following condition as shown in Fig. 43 (please observe Assembly Instructions given in 7.1.7):

Fan impeller fitted
Water insert fitted
Brown cover plate inclined
Support surface inclined
Plexiglas hood opened up
Inlet and ports open
2 cabinet doors open
Connect to power at an Aseptor socket
Selector switch set to «Disinfection in Dräger Aseptor».

The following parts are not assembled and are placed separately in the Aseptor:

Water gauge, mattress, light grey support surface of Incubator 7520, hood inner wall (if applicable).

The bacterial filters must not be placed in the Aseptor or sterilized in ethylene oxide.

7.1.4

Reduction of the residual concentration of disinfectant residues

Following disinfection the Incubator must be thoroughly aerated to reduce

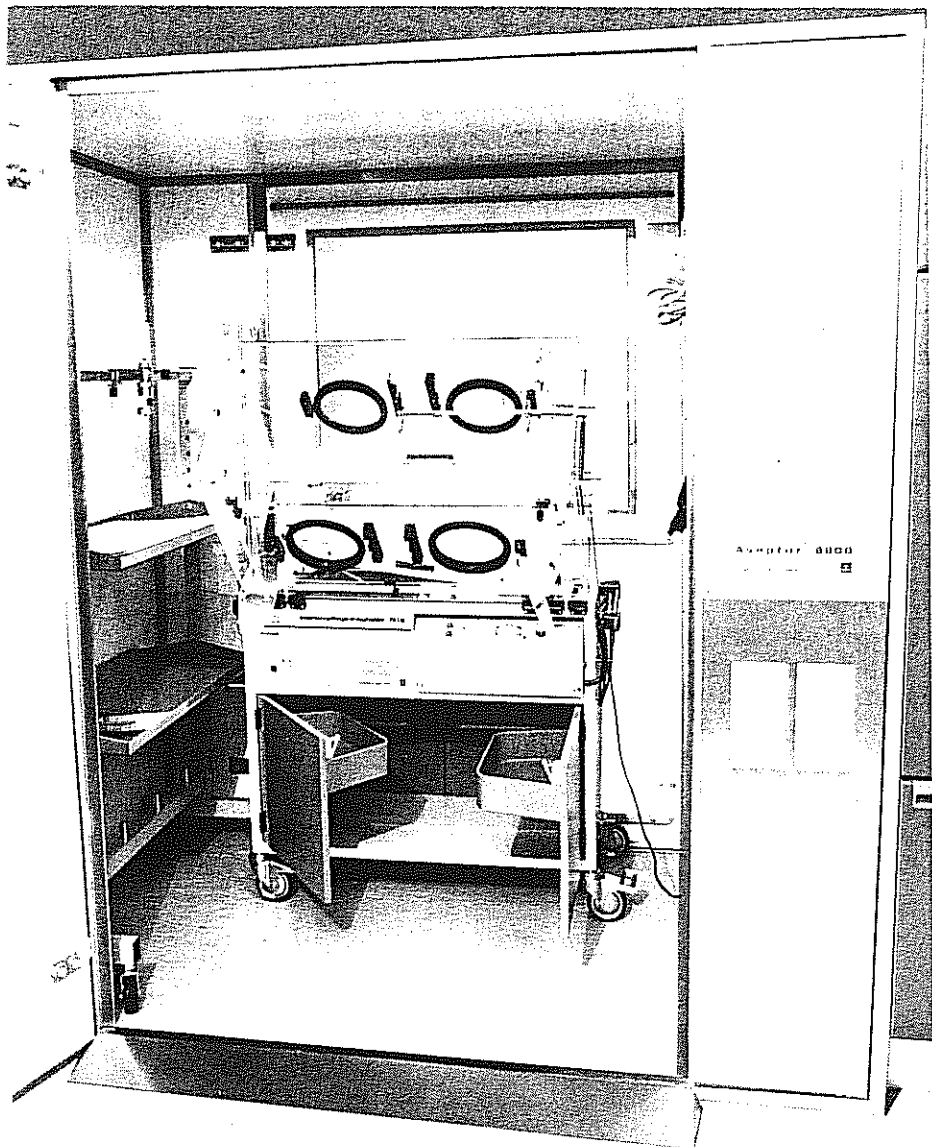

Fig. 43 Incubator in the Dräger Aseptor

the residual concentration of possible disinfection residues.

To do this, switch on the Incubator and set air-temperature regulation to 37°C. We recommend using the Dräger filter fan 7782175 (see relevant Operating Manual) for rapid and effective aeration of the apparatus to remove disinfectant residues.

7.1.5

Sterilization

The water gauge and fan impeller can be sterilized at 134°C. The bacterial filters can be sterilized eight times (also at max. 134°C), with a mark being made on the appropriate part of the filter label following each sterilization process (make scratches with a hard object).

7.1.6

Do not use ultraviolet radiation as a means of disinfection

Ultraviolet radiation would damage the plastic parts of the Incubator – partic-

ularly the Plexiglas hood – as it would cause cracks. This risk is not associated with the longer-wave radiation of the phototherapy lamp.

7.1.7

Assembly of the apparatus

The following sequence must be observed when assembling the Incubator (some of this is already covered by preparation for disinfection in the Aseptor as described in 7.1.3):

● Fan impeller

The fan impeller is fitted onto the motor shaft, which should have been previously greased, as far as the stop. Hold the fan impeller using the left hand, tighten the knurled nut with the right hand.

Check that the fan impeller really is firmly secured to the motor shaft and check that it can rotate freely once the air duct has been closed.

● Water insert (sloping side wall of the insert must be pointing outwards).

- **Cover plate** (the ventilation slits of the cover plate must be pointing to the right-hand outer side of the Incubator),
- **Support surface** (with Incubator 7520 the X-ray drawer must be pointing towards the front of the Incubator),

- **Mattress,**
- **Water gauge,**
- **Two bacterial filters with pressure plate**

Important: Fit sterilized or new bacterial filters (see also 7.1.5).

Fit filters only in direction of arrow (Arrow points towards the «clean» side; this must point towards the inside of the apparatus).

- **Accessories**

7.2

Checking readiness for operation

- Connect apparatus to mains supply and set selector switch to «Air-temperature regulation».
- Check functioning of all alarms by pressing the red warning lamp buttons.

The red warning lamp must light and the buzzer must sound.

The «excess temperature» alarm must then be cancelled by depressing the «reset button».

If the «power failure» alarm does not work – fit or replace battery. Use only leakproof batteries, 1.5 V IEC LR 20. Positive terminal must be at top (Fig. 44).

- The set air temperature must be attained after ½ ... 1 hour (with ± 1°C accuracy). The small «heating» lamp should flash intermittently.
- Check O₂ concentration. With an oxygen supply rate of 6 L/min there should be an oxygen concentration



Fig. 44 Replacing battery for power-failure alarm

of approx. 40% in the Incubator (after approx. 30 minutes).

- Do not fill with distilled water until immediately prior to use of the Incubator.

If checking reveals faults, these must be remedied as described in the Section on «Trouble Shooting».

It is best to have the following servicing operations performed by the Drägerwerk AG Technical Customer Service:

- Every 6 months the motor of the fan must be lubricated (with 10 drops of oil, DIN 51524-HLP 32) and checked by an expert. Wear may lead to the motor creating an unreasonable noise level inside the Incubator.

- Check the skin-temperature display and regulation every 6 months:

Skin-temperature display:

(see also calibration instructions described in 3.1.3): Prepare a water bath with water at approx. 36.5°C near to the Incubator and immerse the skin-temperature sensor and an accurate mercury thermometer in this water. Compare skin-temperature display with that of the thermometer.

Skin-temperature regulation:

Set switch to «Air-temperature regulation 33°C». Wait until the «heating» lamp flashes intermittently (actual value = desired value).

Switch to «Skin-temperature regulation». Heat skin-temperature sensor to approx. 36.5°C in a water bath (as described above). If the desired value is set slightly higher than the actual value, the «heating» lamp must light. If the desired value is reduced to the actual value, the lamp must flash intermittently; it must go out when the desired value is set lower than the actual value.

- Hinges, joints and fasteners may wear out – they must therefore be checked every 6 months.

- Replacing a defective unit: Remove the unit by unfastening the two large screws in the front panel.

When fitting a new unit please observe the following – completely tighten the two screws to secure the unit. Perform visual inspection with Incubator open (as shown in Fig. 42) to check that

- the oval seal in the heating chamber properly fits on the unit.
- the heating coil is not touching the apparatus housing at any point.
- the fan impeller can rotate freely with the air duct closed.

All routine checks must be performed as described in 7.2.

7.3

Storage

Place a dust cover over the Incubator to protect it until it is next required.

If the apparatus is likely to be out of operation for a lengthy period (approx. 6 months), the battery for the power-failure alarm must be removed (see Fig. 44).

7.4

Apparatus inspection

It is advisable to conclude a Servicing Agreement with Drägerwerk AG to guarantee that Incubators and accessories are always operational.

Specially trained inspection engineers will then check the apparatus at regular intervals, they will remedy any faults and will also be pleased to provide expert advice.

If you wish to enter into a Servicing Agreement please contact your local Dräger Branch/Agency.

8 Order List

Designation and description	Order No.	Weight kg
Basic Models		
Incubator 7321 with trolley, air-temperature regulation; without iris diaphragms ¹⁾ , without swivelling windows ¹⁾	2M 19007	49.8
Incubator 7322 with trolley, air and skin-temperature regulation; without iris diaphragms ¹⁾ , without swivelling windows ¹⁾	2M 19008	50.0
Intensive-care Incubator 7521 with trolley, air-temperature regulation; hood without swivelling windows ¹⁾ , without iris diaphragms ¹⁾	2M 19009	64.8
Intensive-care Incubator 7522 with trolley, air and skin-temperature regulation; hood without swivelling windows ¹⁾ , without iris diaphragms ¹⁾	2M 19010	65.0
Please additionally order, either Swivelling Window Conversion Kit and/or Iris Diaphragms Conversion Kit 1 conversion kit is required for the front and 1 for the back, it is also possible for fittings at front and back to be different. If this required, please indicate: Which conversion kit at front? Which conversion kit at back?	2M 17985 2M 17960	
Accessories required for operation		
Oxygen flowmeter 0–15 L/min²⁾ with connection socket and rubber hose	2M 17746	1.0
Additionally for O ₂ supply		
a) From oxygen cylinder:		
Oxygen cylinder 11 litres, filled, 200 bar	B 2 710	20.2
Cylinder jacket with valve cap and base ring for 11 litre cylinder	M 3 691	3.68
Trolley for 11 litre cylinder	M 20 513	5.05
Oxygen pressure reducer	D 17 251	1.02
Oxygen connecting hose, 3 m or	M 14 565	0.22
Oxygen connecting hose, 5 m	M 17 263	0.42
b) From a central supply unit:		
Oxygen connecting hose, 3 m or	M 22 346	0.34
Oxygen connecting hose, 5 m	M 22 347	0.50
Special accessories for Incubators 7320 and 7520		
To develop the trolley into the cabinet model (as Fig. 1 b) please additionally order: Doors Conversion Kit (supplied completely assembled as cabinet model)	2M 17210	10.0
If the double wall system is required for the Plexiglas hood, please also order: Double Wall Conversion Kit for Incubator 7320 Double Wall Conversion Kit for Intensive-care incubator 7520 Supplied completely assembled in the Plexiglas hood. If ordered subsequently, the Technical Customer Service of Drägerwerk AG must be called in to perform installation work.	2M 18564 2M 18590	
Set of supports (to fix support surface in inclined position from outside, for incubator 7320 only)	2M 14535	0.3
Oxygen limiter (only in conjunction with flowmeter 0–15 L/min)	2M 16010	0.5
Fittings for O₂ inhalation		
Plexiglass helmet	2M 14790	
Oxygen flowmeter²⁾	2M 17746	
Humidifier/nebulizer	M 19 995	
Set of corrugated hoses, 1 m (5 x)	2M 17478	
McGaw water nebulizer (cold)		
Accessories required for operation		
Oxygen flowmeter²⁾	2M 17746	
Hose (set of 5)	84 03 897	
McGaw water nebulizer (hot)	2M 19030	
Accessories required for operation		
Oxygen flowmeter²⁾	2M 17746	
McGaw nebulizer heater	2M 18850	
Hose (set of 5)	84 03 897	
Adapter	2M 16843	
Adapter	2M 18750	
Oxygen/compressed-air connecting hose, 1.5 m	M 17 716	

¹⁾ Only one order required

Designation and description	Order No.	Weight kg
Connecting hoses to central supply units Oxygen connecting hose, 3 m Oxygen connecting hose, 5 m	M 22 346 M 22 347	
Oxygen distributor battery comprising: pressure reducer, bracket for O ₂ cylinder, O ₂ connection hose, O ₂ distributor Oxygen cylinder, 3 L or Oxygen distributor (without cylinder connection)	2M 18 828 B 2 533 2M 18 810	
Connecting hoses to central supply units (also required with O ₂ distributor battery) Oxygen connecting hose, 3 m Oxygen connecting hose, 5 m	M 22 346 M 22 347	
Incubator scale, suitable for calibration Necessary fittings: Weighing hook Scale holder Weighing sheet, plastic Weighing sheet, fabric	2M 2 490 2M 2 481 2M 6 003 2M 4 10 2M 6 345	1.15
Infusion stand Small operating-theatre lamp (220 V) Holder for operating-theatre lamp (necessary) Oddments tray (30 x 20 cm)	2M 16 520 2M 13 400 2M 16 510 M 14 678	
Bronchial aspirator, Incubator, ejector type 0.9 bar Bronchial aspirator, Incubator, ejector type 0.5 bar Fingertip (set of 100) Connecting hoses to central supply units O ₂ /compr.-air connecting hose, 0.8 m } Connection to O ₂ /compr.-air connecting hose, 2 m } O ₂ -distributor O ₂ /compr.-air connecting hose, 3 m } Connection to O ₂ /compr.-air connecting hose, 5 m } wall outlet	2M 85 040 2M 85 045 M 24 745 M 17 735 M 22 360 M 22 361 M 22 362	
Vacuum mattress (76 x 42 cm) Securing straps for holding baby (for Incubator 7520 only) Phototherapy unit Stand for phototherapy unit	2M 16 920 2M 13 898 2M 18 800 2M 18 780	10.3 13.6
Oxydig, oxygen meter and monitor including sensor capsule Sensor capsule for Oxydig Oxygen meter holder on Incubator Sealing ring for intermittent measurement Filter fan for rapid and effective aeration of the Incubator to eliminate disinfectant residues	83 03 236 68 03 290 2M 17 770 2M 15 090 77 82 175	
Dust cover	2M 6 835	
Spare parts and wearing parts Bacterial filter (set of 5) Battery for power-failure alarm Mattress for Incubator 7320 Mattress for Incubator 7520 Water gauge Thermometer Hose for hand port (iris diaphragm), set of 10 Seal for swivelling window Skin-temperature sensor, calibrated, including 100 adhesive rings Adhesive rings (set of 100) Screwdriver for setting skin-temperature desired value Bottle of motor oil (fan) Knurled nut for fastening of double wall and scale holder	67 27 154 13 36 053 2M 16 194 2M 17 460 2M 16 333 2M 11 111 2M 16 751 2M 15 966 2M 18 830 68 02 428 13 22 923 2M 7 839 2M 6 004	

9 Dimensional drawings

Dimensions in mm

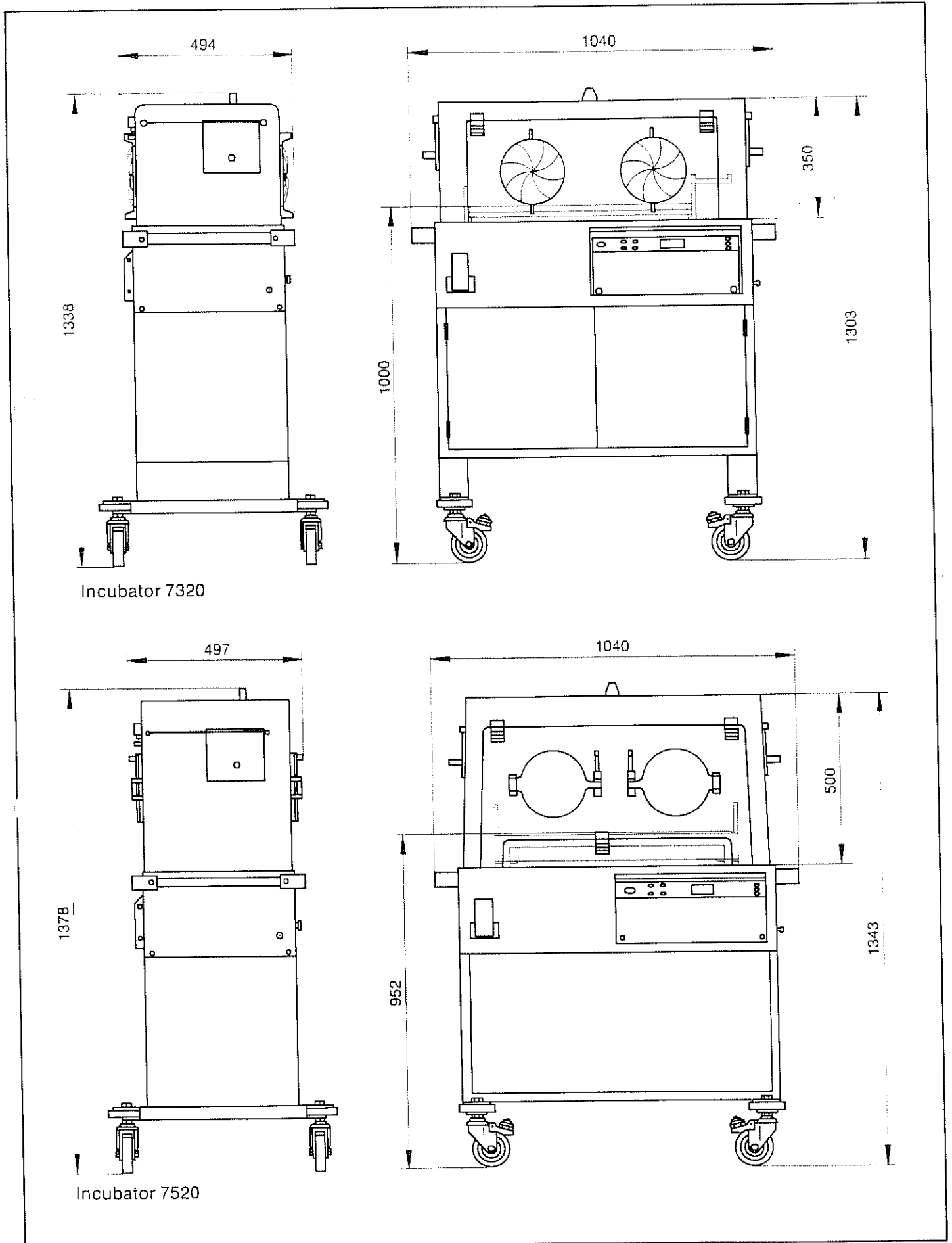

Fig. 45 Dimensions

Drägerwerk Aktiengesellschaft Lübeck

Federal Republic of Germany

✉ Postfach 1339, 🏠 Moislinger Allee 53/55
D-2400 Lübeck 1

☎ (451) 882-0, 📠 26807-0, FAX (451) 882-2080