

BECKMAN COULTER™
AC•T™ 5diff Hematology Analyzer

Operator's Guide

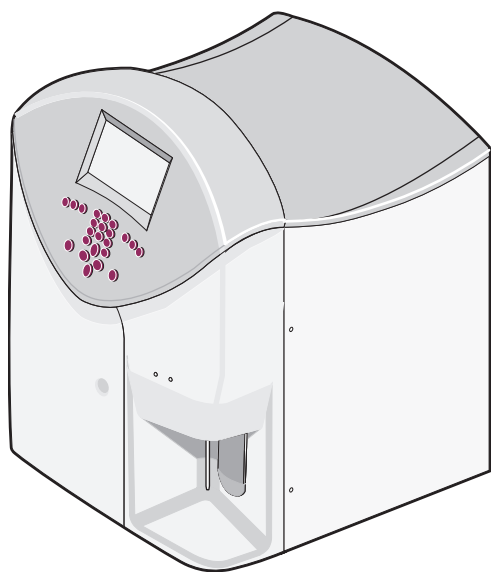

READ ALL PRODUCT MANUALS AND CONSULT WITH BECKMAN COULTER-TRAINED PERSONNEL
BEFORE ATTEMPTING TO OPERATE INSTRUMENT.

HAZARDS AND OPERATIONAL PRECAUTIONS AND LIMITATIONS

WARNINGS, CAUTIONS, and IMPORTANTS alert you as follows:

- WARNING** - Might cause injury.
- CAUTION** - Might cause damage to the instrument.
- IMPORTANT** - Might cause misleading results.

CAUTION System integrity might be compromised and operational failures might occur if:

- This equipment is used in a manner other than specified. Operate the instrument as instructed in the Product Manuals.
 - You introduce software that is not authorized by Beckman Coulter into your computer. Only operate your system's computer with software authorized by Beckman Coulter.
 - You install software that is not an original copyrighted version. Only use software that is an original copyrighted version to prevent virus contamination.
-

Beckman Coulter, Inc. urges its customers to comply with all national health and safety standards such as the use of barrier protection. This may include, but it is not limited to, protective eyewear, gloves, and suitable laboratory attire when operating or maintaining this or any other automated laboratory analyzer.

WARNING Risk of operator injury if all covers are not secured in place prior to instrument operation or you attempt to replace a part without carefully reading the replacement instructions. Do not attempt to replace any component until you carefully read the instructions for replacing the component.

IMPORTANT If you purchased this product from anyone other than Beckman Coulter or an authorized Beckman Coulter distributor, and, if it is not presently under a Beckman Coulter service maintenance agreement, Beckman Coulter cannot guarantee that the product is fitted with the most current mandatory engineering revisions or that you will receive the most current information bulletins concerning the product. If you purchased this product from a third party and would like further information concerning this topic, call your Beckman Coulter Representative.

Initial Issue, 03/00
Software version 0.11

Issue B, 07/00
Software version 1.0

This document applies to the latest software listed and higher versions. When a subsequent software version changes the information in this document, a new issue will be released.

REVISION STATUS

REVISION STATUS

INTRODUCTION, xvii

HOW TO USE YOUR AC•T 5diff HEMATOLOGY ANALYZER MANUALS, xvii

ABOUT THIS MANUAL, xvii

CONVENTIONS, xix

GRAPHICS, xix

SYMBOLS, xx

Safety Symbols, xx

Tab Symbols, xx

MENU TREE, xxi

1 USE AND FUNCTION, 1-1

1.1 INTENDED USE, 1-1

General, 1-1

Purpose, 1-1

Instrument Description, 1-1

Control Panel, 1-3

Back Panel, 1-4

Warning and Caution Labels, 1-4

Modes, 1-5

Parameters, 1-5

CBC Mode, 1-5

CBC/DIFF Mode, 1-6

Features, 1-6

Reports, 1-6

1.2 CONTROLS AND CALIBRATORS, 1-7

Cell Controls, 1-7

Calibrator, 1-7

1.3 REAGENTS, 1-7

AC•T 5diff Diluent, 1-8

AC•T 5diff Fix, 1-8

AC•T 5diff WBC Lyse, 1-8

AC•T 5diff Hgb Lyse, 1-8

AC•T 5diff Rinse, 1-8

Waste Handling Procedures, 1-9

Neutralizing the Waste and Treating for Biohazards, 1-9

Handling Expired Reagents, 1-10

1.4 PRINTER, 1-10

1.5 RANGES, 1-10

- 1.6 WORKING WITH THE SOFTWARE, 1-11
 - Moving the Cursor, 1-11
 - Selecting Menu Items, 1-11
 - Erasing Saved Text, 1-12
 - Selecting/De-selecting Software Fields, 1-12
- 1.7 PRESENTING SAMPLES TUBES (OR VIALS) AND STARTING ANALYSIS, 1-13
- 1.8 ORDERING MATERIAL SAFETY DATA SHEETS (MSDS), 1-13
- 2 OPERATION PRINCIPLES, 2-1**
 - 2.1 OVERVIEW, 2-1
 - 2.2 MEASUREMENT PRINCIPLES, 2-1
 - Coulter Principle, 2-1
 - Aperture Sensor System, 2-1
 - Applying the Coulter Principle, 2-2
 - 2.3 A^CV TECHNOLOGY, 2-3
 - Dual Focused Flow (DFF), 2-3
 - Flowcell, 2-3
 - Focused Flow Impedance, 2-3
 - Absorbance Cytochemistry, 2-4
 - Signal Processing, 2-4
 - Thresholds, 2-4
 - 2.4 WBC/BASO METHODOLOGY, 2-5
 - 2.5 SAMPLE ANALYSIS OVERVIEW, 2-5
 - Aspiration, 2-5
 - Dilution, 2-6
 - CBC Mode, 2-7
 - CBC/DIFF Mode, 2-7
 - Delivery, 2-7
 - 2.6 SAMPLE ANALYSIS, 2-8
 - RBC and Platelet Analysis, 2-8
 - Parameter Results Obtained from the RBC/Plt Dilution, 2-9
 - Hgb Measurement, 2-9
 - WBC Count and Differential, 2-10
 - Parameter Results Obtained from the WBC/BASO Dilution, 2-11
 - Differential, 2-11
 - Parameter Results Obtained from the DIFF Dilution, 2-12
 - Dilution Summary, 2-13

- 2.7 PARAMETER DEVELOPMENT, 2-13
 - RBC Parameters, 2-13
 - RBC Count, 2-13
 - RBC Histogram, 2-14
 - Parameter Results Obtained Using the RBC Histogram, 2-14
 - MCH and MCHC Calculations, 2-15
 - Plt Parameters, 2-15
 - Interference on the Lower End of the Platelet Distribution Curve, 2-15
 - Microcytic Interferences on the Upper End of the Platelet Distribution Curve, 2-16
 - Parameter Results Obtained Using the Plt Histogram, 2-16
 - Hgb Determination, 2-17
 - WBC Count, BASO Count, and DiffPlot Development, 2-17
 - WBC Count, 2-17
 - BASO Count, 2-17
 - DiffPlot Development, 2-18
- 3 SPECIFICATIONS/CHARACTERISTICS, 3-1
 - 3.1 INSTRUMENT SPECIFICATIONS, 3-1
 - Dimensions and Weight, 3-1
 - Power, 3-1
 - Supply, 3-1
 - Consumption, 3-1
 - Installation Category, 3-1
 - Grounding Requirements, 3-1
 - Temperature, Ambient Operating, 3-1
 - Altitude Range, 3-2
 - Recommended Location, 3-2
 - Electromagnetic Environment Check, 3-2
 - Recommended Reagents, 3-2
 - Recommended Controls, 3-2
 - Recommended Calibrator, 3-2
 - Recommended Anticoagulant, 3-2
 - Sample Volume Aspirated, 3-2
 - Dilution Ratios, 3-2
 - Throughput, 3-3
 - Sample Stability, 3-3
 - Sample Identification, 3-3
 - Output, 3-3
 - Measurements and Computation, 3-4
 - Counting Aperture Diameters, 3-4
 - Reagent Consumption, 3-4
 - Environmental Protection, 3-4
 - 3.2 PERFORMANCE SPECIFICATIONS, 3-5
 - Reproducibility, 3-5
 - Linearity, 3-5
 - Accuracy, 3-5
 - Carryover, 3-6
 - Reportable Range, 3-6

- 3.3 PERFORMANCE CHARACTERISTICS, 3-7
 - Reproducibility, 3-7
 - Accuracy, 3-8
 - Carryover, 3-8
- 3.4 LIMITATIONS, 3-8
 - Maintenance, 3-8
 - Blood Specimens, 3-8
- 3.5 INTERFERING SUBSTANCES, 3-9
- 4 PRECAUTIONS/HAZARDS, 4-1
 - 4.1 DEFINITIONS, 4-1
 - Warnings, 4-1
 - Cautions, 4-1
 - Importants, 4-1
 - Attention, 4-1
 - 4.2 SAFETY PRECAUTIONS, 4-1
 - Electronic, 4-1
 - Biological, 4-1
 - Moving Parts, 4-1
 - 4.3 OPERATIONAL HAZARDS, 4-2
- 5 RUNNING SAMPLES, 5-1
 - 5.1 BEFORE ANALYSIS, 5-1
 - Waste Container Level Check, 5-1
 - Printer Check, 5-1
 - Startup, 5-2
 - Startup During Power Up, 5-2
 - Startup After Power Up, 5-3
 - Specimen Collection and Mixing, 5-5
 - Running Cell Controls to Verify Calibration, 5-5
 - 5.2 ANALYSIS, 5-8
 - Running Whole-Blood Samples, 5-8
 - 5.3 AFTER ANALYSIS, 5-10
 - Results, 5-10
 - Printing Results for Last Sample Analyzed, 5-10
 - Auto-Clean, 5-11
 - 5.4 SHUTDOWN, 5-11
 - 5.5 ENTERING THE SAMPLE IDENTIFICATION (ID), 5-11
 - Auto-Numbering, 5-11
 - Manual Sample ID, 5-12
 - Scanning the Sample ID with the Barcode Reader, 5-13

- 6 REVIEWING RESULTS, 6-1
 - 6.1 GENERAL, 6-1
 - 6.2 FLAGS AND INTERPRETIVE MESSAGES, 6-1
 - Flags, 6-1
 - Definition, 6-1
 - Types of Flags, 6-1
 - Types of Flag Printout Formats, 6-1
 - Interpretive Messages, 6-2
 - Definition, 6-2
 - 6.3 FLAGS GENERATED BY THE INSTRUMENT, 6-2
 - Results Exceeding Instrument Capacity, 6-2
 - Hemoglobin Errors, 6-2
 - Hgb Blank Error, 6-2
 - Hgb Read Error, 6-2
 - Voteout Flag, 6-3
 - WBC Count Flag, 6-3
 - DiffPlot Flags, 6-3
 - CBC Flags, 6-8
 - Suspect or Detailed Flag Format, 6-11
 - Suspect Flag Format, 6-11
 - Detailed Flag Format, 6-12
 - Patient Ranges and Action Ranges, 6-12
 - 6.4 INTERPRETIVE MESSAGES, 6-12
 - WBC Interpretive Messages, 6-13
 - RBC Interpretive Messages, 6-13
 - Plt Interpretive Messages, 6-14
 - Combination WBC/RBC/Plt Interpretive Messages, 6-14
- 7 CALIBRATION, 7-1
 - 7.1 GENERAL, 7-1
 - Recommended Calibration Conditions, 7-1
 - When to Calibrate, 7-1
 - When to Verify Calibration, 7-1
 - 7.2 PRE-CALIBRATION CHECKS, 7-1
 - 7.3 AUTO-CALIBRATION, 7-3
 - Calibration Setup, 7-3
 - Running Calibration, 7-5
 - Interpreting Calibration Results, 7-9
 - Forced Calibration, 7-9
 - 7.4 MANUAL CALIBRATION FACTOR ADJUSTMENT, 7-11
 - 7.5 PRINTING CALIBRATION FACTORS, 7-14

- 8 DIAGNOSTICS, 8-1**
 - 8.1 GENERAL MAINTENANCE, 8-1
 - 8.2 MAINTENANCE SCHEDULE, 8-1
 - 8.3 CLEANING PROCEDURES, 8-2
 - Cleaning the Outside of the Instrument, 8-2
 - Cleaning the Inside of the Instrument, 8-2
 - Extended Cleaning Procedure, 8-2
 - Auto-Clean, 8-4
 - Shutdown, 8-5
 - System Cleaning, 8-5
 - 8.4 SYSTEM RESET CYCLE, 8-9
 - 8.5 COMPONENT LOCATIONS, 8-10
 - 8.6 SYSTEM TROUBLESHOOTING PROCEDURES, 8-12
 - Diluter System, 8-12
 - Backflush, 8-12
 - Bath and Flowcell Rinse, 8-13
 - Draining the Baths and/or the Diluent Reservoir, 8-14
 - Hardware System, 8-15
 - Hardware Reset, 8-15
 - Checking the Valves, 8-15
 - Checking the Motors, 8-15
 - 8.7 REPLACEMENT PROCEDURES, 8-15
 - Replacing Reagents, 8-15
 - Viewing Reagent Levels, 8-16
 - Replacing the Diluent Reagent, 8-17
 - Replacing Fix, WBC Lyse, Hgb Lyse, and Rinse Reagents, 8-21
 - Priming the Reagents, 8-26
 - Replacing the Waste Container, 8-27
 - Replacing the Flowcell Lamp, 8-29
 - 8.8 SYSTEM ERRORS, 8-34
 - What Error Messages Mean, 8-34
 - 8.9 TROUBLESHOOTING GUIDES, 8-36
- A INSTRUMENT SETUP, A-1**
 - A.1 INSTALLATION, A-1
 - A.2 DEFAULT CONFIGURATION, A-1
 - A.3 CHANGES TO INSTRUMENT SETUP, A-2
 - A.4 LANGUAGE AND USA FIELD SELECTION, A-2
 - A.5 PASSWORD SETUP, A-3

- A.6 DATE/TIME SETUP, A-4
 - Date Setup, A-4
 - Selecting the Date Format, A-4
 - Selecting the Time Format, A-5
 - Setting a New Date and Time, A-5
- A.7 REPORTING UNIT SELECTION, A-7
- A.8 LABORATORY LIMITS SETUP, A-8
 - Patient Ranges, A-8
 - Changing CBC Patient Ranges, A-9
 - Changing DIFF Patient Ranges, A-11
 - Action Ranges, A-13
 - Changing CBC Action Ranges, A-13
 - Changing DIFF Action Ranges, A-15
- A.9 SETTING FLAG SENSITIVITY AND THRESHOLDS, A-17
- A.10 PRINTER CONFIGURATION, A-18
 - Configuring the Instrument's Printer Settings, A-18
 - Printing Options, A-20
- A.11 ENTERING/EDITING THE INSTITUTIONAL HEADER, A-21
- A.12 PRINTING A SYSTEM SETUP REPORT, A-22
- A.13 CALIBRATION SETUP, A-23
 - Changing CV% Limits, A-23
 - Defining the Operator, A-25
- A.14 SELECTING THE SAMPLE IDENTIFICATION (ID) MODE, A-27
- A.15 DISPLAYING DIFF # OR DIFF %, A-28
- A.16 ENABLING ATL, IMM, PCT, AND PDW, A-28
- A.17 RESETTING THE MANUAL SAMPLE ID NUMBER AND INSTRUMENT SEQUENCE NUMBER TO "1", A-29
- A.18 SELECTING BARCODE WITH CHECKSUM, A-30
- A.19 AUTO-CLEAN FREQUENCY SETTING, A-31
- A.20 CHANGING THE DAILY WORKLOAD, A-32
- A.21 REAGENT VOLUMES SETUP, A-33
- A.22 VIEWING THE CYCLE COUNT, A-34

CONTENTS

B LOG SHEETS, B-1

ACTION LOG, B-2

MAINTENANCE LOG, B-3

REAGENT LOG, B-4

C MANUAL CALIBRATION, C-1

C.1 ANALYSIS PROCEDURE, C-1

C.2 CALCULATIONS PROCEDURE, C-2

C.3 CALCULATING NEW CALIBRATION FACTORS, C-3
Calibration Worksheet, C-4

D TROUBLESHOOTING FLOWCHART, D-1

D.1 TROUBLESHOOTING FLOWCHART, D-1

E TRAINING CHECKLIST, E-1

E.1 INSTALLATION, E-1

E.2 GENERAL, E-1

E.3 SAMPLE HANDLING, E-1

E.4 INSTRUMENT COMPONENTS, E-1

E.5 SOFTWARE MENU, E-1

E.6 REAGENTS, E-1

E.7 INSTRUMENT SETUP/CUSTOMIZATION, E-2

E.8 CALIBRATION, E-2

E.9 CONTROLS, E-2

E.10 SYSTEM OPERATION OVERVIEW, E-2

E.11 DAILY PROCEDURES, E-2

E.12 SPECIAL PROCEDURES, E-3

E.13 MAINTAINING AND SERVICING THE INSTRUMENT, E-3

E.14 PAPERWORK, E-3

F BARCODE SPECIFICATIONS, F-1

F.1 OVERVIEW, F-1
Definition, F-1

- E2 BARCODE LABELS, F-1
Symbologies, F-1
- E3 BARCODE SPECIFICATIONS, F-1
- E4 BARCODE LABEL TEST PAGES, F-3
- E5 BARCODE SCANNER CONFIGURATION, F-4
- E6 CODE 39 AND CODABAR BARCODE SCANNER OPTIONS, F-5
- E7 I 2-OF-5 PROGRAMMING OPTIONS AND TEST LABELS, F-7

REFERENCES, REFERENCES-1

- LIST OF REFERENCES, REFERENCES-1

GLOSSARY, GLOSSARY-1

- DEFINITIONS, GLOSSARY-1

ABBREVIATIONS, ABBREVIATIONS-1

- LIST OF ABBREVIATIONS, ABBREVIATIONS-1

INDEX, INDEX-1

TRADEMARKS

ILLUSTRATIONS

- 1.1 A^C•T 5diff Analyzer, 1-1
- 1.2 Outside View of the Instrument, 1-2
- 1.3 Control Panel Buttons, 1-3
- 1.4 Back Panel, 1-4
- 1.5 Warning and Caution Labels on the Instrument, 1-4
- 2.1 Coulter Principle, 2-2
- 2.2 Dual Focused Flow Process, 2-3
- 2.3 Signal Processing, 2-4
- 2.4 BASO Thresholds, 2-5
- 2.5 Sample Partitions Inside the Probe - CBC/DIFF Mode, 2-6
- 2.6 Sample Partitions Inside the Probe - CBC Mode, 2-6
- 2.7 Bath Assembly, 2-6
- 2.8 Sample Delivery Using Tangential Flow, 2-7
- 2.9 Bath Assembly, 2-8
- 2.10 Bath Assembly, 2-10
- 2.11 Flowcell Operation, 2-11
- 2.12 DiffPlot Regions, 2-12
- 2.13 Typical RBC Histogram, 2-14
- 2.14 Typical Plt Histogram, 2-15
- 2.15 Area of the Plt Histogram Used to Determine the PDW Parameter Result, 2-16
- 2.16 Areas Used to Determine WBC and BASO Parameter Results, 2-17
- 2.17 DiffPlot Regions, 2-18

- 3.1 Instrument Dimensions and Weight, 3-1
- 3.2 Sample Report, 3-3
- 5.1 Sample Report, 5-10
- 6.1 WBC/BASO Histogram Flags: CBC Mode, 6-8
- 6.2 WBC/BASO Histogram Flags: CBC/DIFF Mode, 6-8
- 6.3 MICRO and MACRO Regions on RBC Histogram, 6-9
- 6.4 Plt Flags, 6-10
- 6.5 Mobile Threshold Positioned in the Standard Regions (Between 18fL and 25fL), 6-10
- 6.6 Mobile Threshold Cannot Be Positioned in the Standard Region, 6-10
- 6.7 Mobile Threshold Cannot Be Positioned, 6-10
- 7.1 Out of Range Calibration Factors, 7-9
- 8.1 View of the Pneumatics Area (Right Side), 8-10
- 8.2 Bath Assembly, 8-11
- 8.3 View Behind Motherboard (Left Side), 8-11
- 8.4 Motherboard, 8-12
- 8.5 Reagent Bottle Location, 8-16
- 8.6 Waste Sensor Alarm Unit Location, 8-27
- A.1 Sample Results Report: Areas Defined, A-19
- D.1 Troubleshooting Flowchart, D-1

TABLES

- 1.1 CBC Parameters, 1-5
- 1.2 CBC/DIFF Parameters, 1-6
- 2.1 A^C•T 5diff Analyzer: Measurement Technologies, 2-1
- 2.2 Technical Characteristics for Obtaining RBC and Platelet Counts, 2-8
- 2.3 Technical Characteristics for the Measurement of the Hemoglobin, 2-9
- 2.4 Characteristics Required to Obtain WBC/BASO Results, 2-10
- 2.5 Technical Characteristics for Acquisition of the DiffPlot, 2-12
- 2.6 Summary of Dilutions, 2-13
- 2.7 DiffPlot Regions Defined, 2-19
- 2.8 Immature White Blood Cells, 2-20
- 3.1 Reagent Consumption by Cycle in mL, 3-4
- 3.2 Reproducibility Specifications, 3-5
- 3.3 Linearity Specifications, 3-5
- 3.4 Accuracy Specifications, 3-5
- 3.5 Carryover Specifications, 3-6
- 3.6 Reportable Range, 3-6
- 3.7 Reproducibility Characteristics From a Normal Sample with a Low Normal WBC Count, 3-7
- 3.8 Reproducibility Characteristics From a Normal Sample with a High Normal WBC Count, 3-7
- 3.9 Accuracy Characteristics, 3-8
- 3.10 Carryover Characteristics, 3-8
- 3.11 Interfering Substances, 3-9
- 6.1 Definition of DIFF Flags, 6-4
- 6.2 CBC Histogram Flags, 6-8
- 6.3 Patient Range and Action Range Flags, 6-12
- 6.4 WBC Interpretive Messages from Action Ranges, 6-13
- 6.5 WBC Interpretive Messages from DiffPlot, 6-13
- 6.6 RBC Interpretive Messages from Action Ranges, 6-13
- 6.7 RBC Interpretive Messages from Flag Sensitivity, 6-14

6.8	Plt Interpretive Messages from Action Ranges, 6-14
6.9	Plt Interpretive Messages from the Plt Histogram, 6-14
6.10	Interpretive Messages from a Combination of WBC/RBC/Plt Action Ranges, 6-14
6.11	NRBCs and <i>PLATELET AGGREGATES</i> Interpretive Messages, 6-15
7.1	Calibration Factors Range, 7-13
8.1	Maintenance Schedule, 8-1
8.2	Error Messages, 8-34
8.3	Troubleshooting Guide, 8-36
A.1	Instrument Default Settings, A-1
A.2	Reporting Unit Format, A-7
A.3	CBC Default Patient Ranges, A-9
A.4	DIFF Default Patient Ranges, A-11
A.5	CBC Default Action Ranges, A-13
A.6	DIFF Default Action Ranges, A-15
A.7	Default CV Limits, A-23
A.8	Daily Workload Runs by Mode, A-32
A.9	Default Reagent Volumes, A-33
F.1	Default Barcode Settings, F-2
F.2	Test Labels With the Check Digit (Checksum), F-3
F.3	Test Labels Without the Check Digit, F-3
F.4	Barcode Scanner Configuration Sheet, F-4
F.5	Code 39 Barcode Scanner Options, F-5
F.6	Codabar Barcode Scanner Options, F-6
F.7	Interleaved 2-of-5 Options With Fixed Length Characters Test Labels, F-7

CONTENTS

This introductory section contains the following topics:

- HOW TO USE YOUR AC•T 5diff HEMATOLOGY ANALYZER MANUALS,
- ABOUT THIS MANUAL,
- CONVENTIONS,
- GRAPHICS
- SYMBOLS, and
- MENU TREE.

HOW TO USE YOUR AC•T 5diff HEMATOLOGY ANALYZER MANUALS

Use this Operator's Guide to find information about:

- Getting started,
- Running your instrument,
- Reviewing results,
- Performing special procedures, such as cleaning, replacing, or adjusting an instrument component,
- Troubleshooting problems,
- Determining what the instrument does,
- Understanding how to safely operate the instrument,
- Powering up the instrument,
- Customizing the setup, and
- Running controls and samples.

Use the Host Transmission Specification manual (PN 4277065) to find out information about interfacing your AC•T 5diff analyzer to your laboratory's host computer.

ABOUT THIS MANUAL

The information in this manual is organized as follows:

- Chapter 1, USE AND FUNCTION
Contains the intended use of the instrument, a brief history of the methods used by the instrument, the reagents, calibrators, and controls used, a brief description of the major components, and how to work with the software.
- Chapter 2, OPERATION PRINCIPLES
Contains the descriptions for cell counting and voting and how the parameters are derived.
- Chapter 3, SPECIFICATIONS/CHARACTERISTICS
Details instrument specifications, characteristics, and interfering substances.
- Chapter 4, PRECAUTIONS/HAZARDS
Provides information about key safety issues and contains information on biological hazards and hazards pertaining to moving parts.
- Chapter 5, RUNNING SAMPLES
Provides information on how to run patient blood samples.

- Chapter 6, REVIEWING RESULTS
Provides information on reviewing flagged sample results.
- Chapter 7, CALIBRATION
Provides procedures for calibrating the instrument, including manually adjusting the calibration factors.
- Chapter 8, DIAGNOSTICS
Provides information about special procedures and troubleshooting procedures for the instrument. Includes topics such as a maintenance schedule, cleaning and replacement procedures, and what error messages mean.
- Appendix A, INSTRUMENT SETUP
Provides procedures on customizing the instrument's settings, such as date/time, reporting units, laboratory limits, and others.
- Appendix B, LOG SHEETS
Contains log sheets for your laboratory's use.
- Appendix C, MANUAL CALIBRATION
Provides a procedure for manually calibrating the instrument.
- Appendix D, TROUBLESHOOTING FLOWCHART
Provides supplemental troubleshooting information.
- Appendix E, TRAINING CHECKLIST
Summarizes what must be done after the instrument is installed.
- Appendix F, BARCODE SPECIFICATIONS
Defines the specifications that barcode labels must meet for use with the instrument.
- REFERENCES
Lists references used in this manual.
- GLOSSARY
Defines terminology used in this manual.
- ABBREVIATIONS
Defines abbreviations used in this manual.
- INDEX
Provides page numbers for indexed information.

CONVENTIONS

This manual uses the following conventions:

- Main Menu refers to the initial menu displayed on the instrument after Startup.

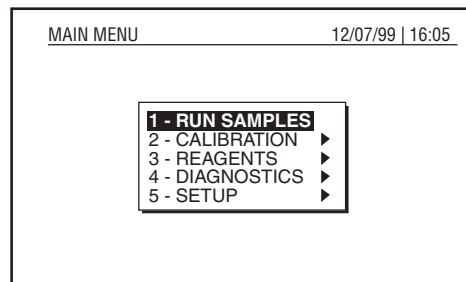

- When instructed to make a menu selection, the text appears in bold with two symbols to distinguish the menu path. For example, if instructed to choose Calibration, then Autocalibration, the text will appear as **CALIBRATION >> AUTOCALIBRATION**.
- **Bold font** indicates a menu option, such as **SETUP**.
- *Italics font* indicates screen text displayed on the instrument, such as *Calibration Passed*.
- **Bold, italics font** indicates a heading name within this document. For example, you may be instructed to do the Startup procedure, which would appear as “Do ***Startup***”.
- Instrument refers to the A^C•T 5diff hematology analyzer.
- A Note contains information that is important to remember or helpful when performing a procedure.
- Motherboard refers to the main card (board) in the instrument.
- RBC bath is sometimes referred to as RBC/Plt bath.
- A^C•T 5diff Rinse reagent is sometimes referred to as Rinse.
- A^C•T 5diff Fix reagent is sometimes referred to as Fix.
- A^C•T 5diff Hgb Lyse reagent is sometimes referred to as Hgb Lyse.
- A^C•T 5diff WBC Lyse reagent is sometimes referred to as WBC Lyse.
- A^C•T 5diff Diluent reagent is sometimes referred to as Diluent.



GRAPHICS

All graphics, including screens and printouts, are for illustration purposes only and must not be used for any other purpose.

SYMBOLS





Safety Symbols

Safety symbols alert you to potentially dangerous conditions. These symbols, together with text, apply to specific procedures and appear as needed throughout this manual.

Symbol	Warning Condition	Action
	Biohazard. Consider all materials (specimens, reagents, controls, and calibrators, and so forth) and areas these materials come into contact with as being potentially infectious.	Wear standard laboratory attire and follow safe laboratory procedures when handling any material in the laboratory.
	Probe hazard. The probe is sharp and may contain biohazardous materials, such as controls and calibrators.	Avoid any unnecessary contact with the probe and probe area.
	Electrical shock hazard. Possibility of electrical shock when instrument is plugged in to the power source.	Before continuing, unplug the AC•T 5diff analyzer from the electrical outlet.

Tab Symbols

Tabs divide this document into four sections: reference, operation, special procedures and troubleshooting, and appendices. Each tab reflects a unique symbol.

Symbol	Definition
	Identifies the reference section.
	Identifies the operating instructions section.
	Identifies the special procedures and troubleshooting section.
	Identifies the appendices section.

MENU TREE

The functions of the instrument are programmed into its software.

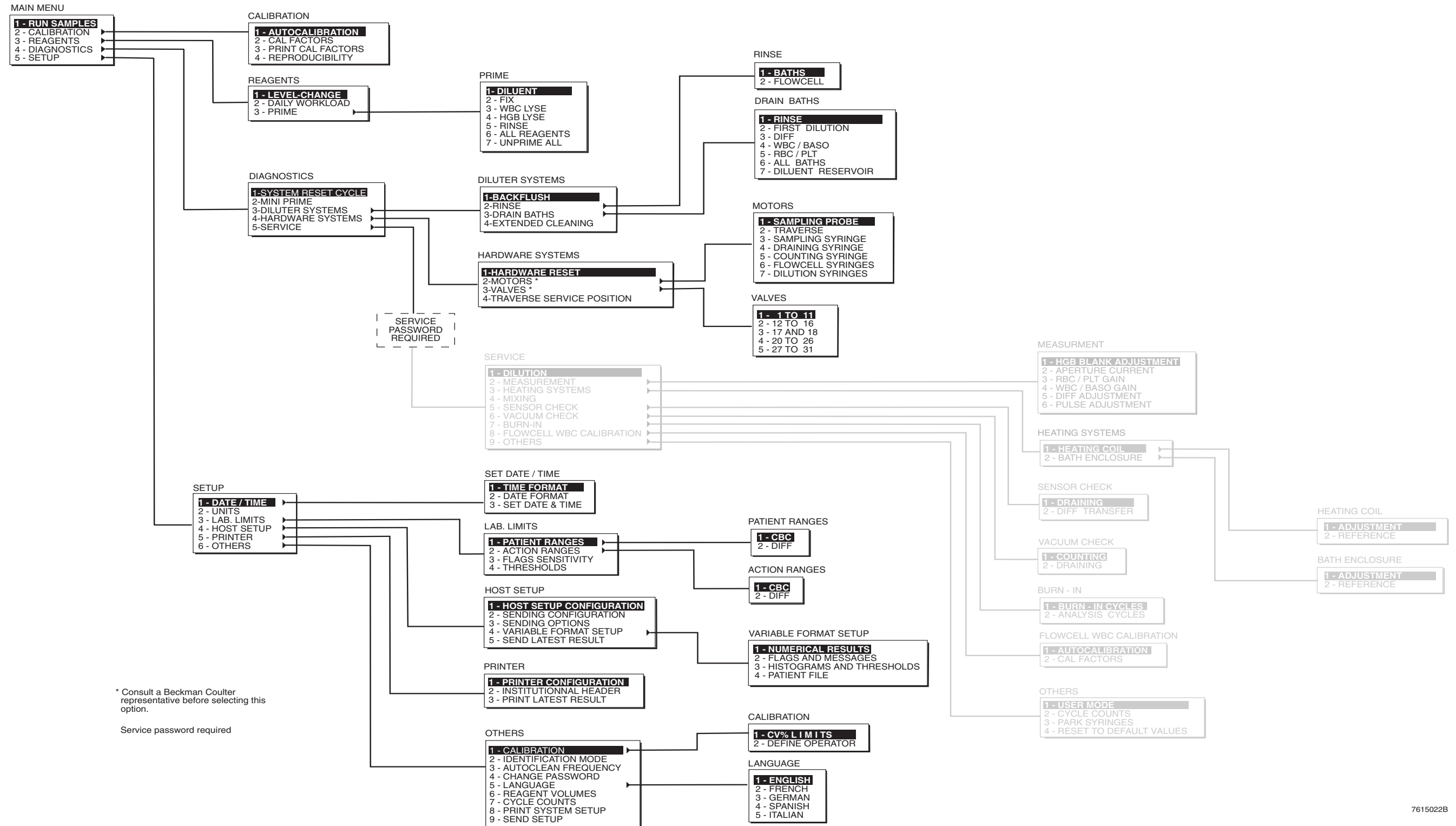



1.1 INTENDED USE

General

The Beckman Coulter AC•T 5diff hematology analyzer (Figure 1.1) is a 26-parameter, fully automated hematology analyzer, including a five-part leukocyte differential counter.

Of the 26 reported parameters:

- 20 parameters are **For In Vitro Diagnostic Use**: WBC, RBC, Hgb, Hct, MCV, MCH, MCHC, RDW, Plt, MPV, NE%, NE#, LY%, LY#, MO%, MO#, EO%, EO#, BA%, and BA#.
- 6 parameters are qualitative and are **For Research Use Only. Not for use in diagnostic procedures.**: Pct, PDW, IMM#, IMM#, ATL%, and ATL#.

Figure 1.1 AC•T 5diff Analyzer

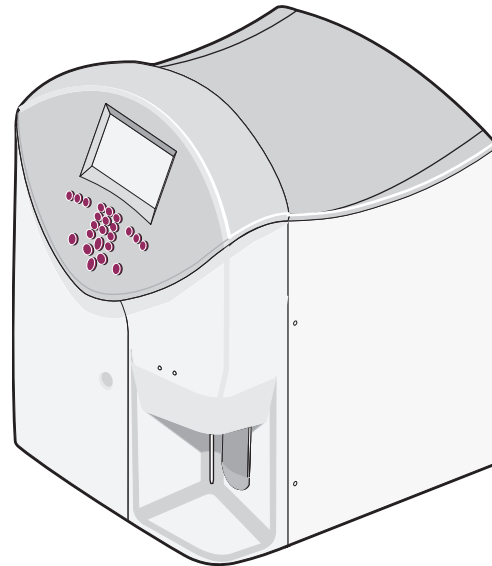

Purpose

The purpose of the AC•T 5diff hematology analyzer is to identify normal patient results with all normal system-generated parameters and to flag or identify patient results that require additional studies.

Instrument Description

- Figure 1.2 shows the outside of the instrument.
- Figure 1.3 shows the control panel.
- Figure 1.4 shows the back panel.
- Figure 1.5 shows the warning and caution labels on the instrument.

WARNING Risk of operator injury when covers and doors are not closed and secured in place before you operate the instrument. Ensure that all covers and doors are closed and secured before operating the instrument.

Figure 1.2 Outside View of the Instrument

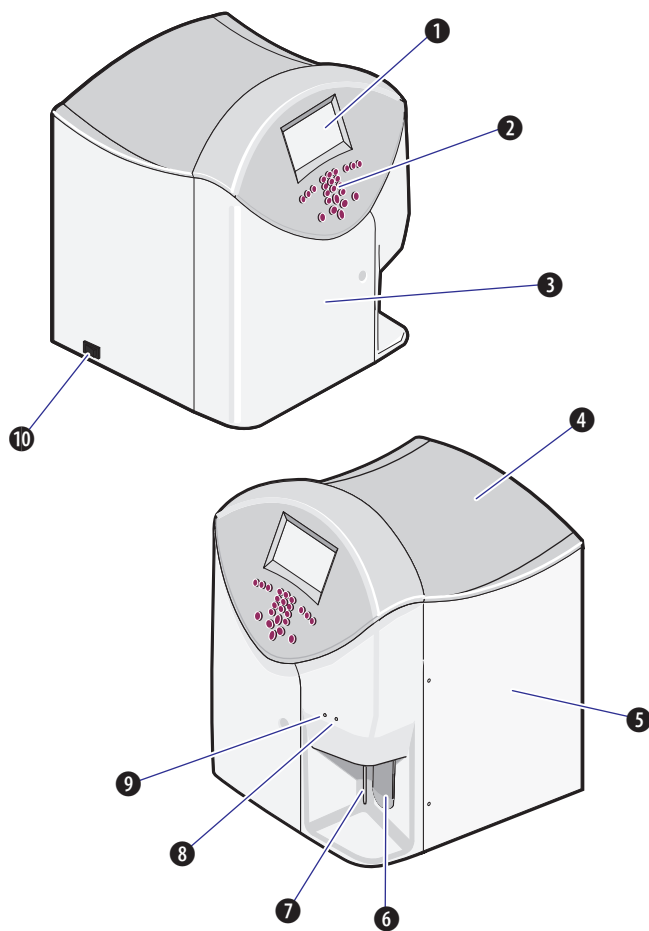

- ❶ LCD (liquid crystal display) screen
- ❷ Control panel: allows you to interface with the instrument. See **Control Panel** for details.
- ❸ Door to reagents: allows you to access the reagent bottles on board.
- ❹ Top cover
- ❺ Door to pneumatics: allows you to access the hydraulic parts for maintenance procedures.
Note: The system will not operate when this door is open.
- ❻ Aspirate switch: allows you to start an analysis cycle.
- ❼ Aspirate (sample) probe: aspirates sample or control material from tubes or vials.
- ❽ Green LED (light-emitting diode): indicates the instrument is ready.
- ❾ Red LED: indicates the instrument is busy.
- ❿ ON/OFF switch







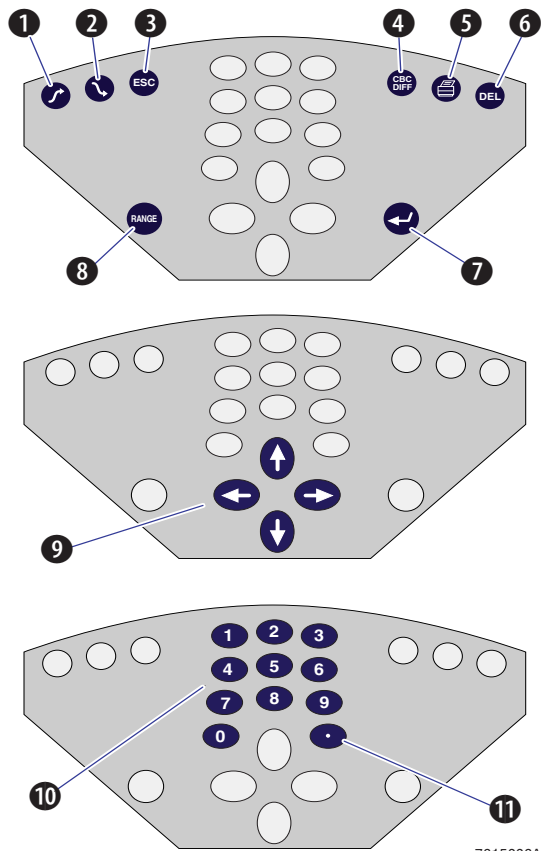



Control Panel

Use the control panel buttons (Figure 1.3) to setup and operate the instrument.

Figure 1.3 Control Panel Buttons



7615006A

- 1  **Startup** performs a prime and rinsing procedure, followed by a background count.
- 2  **Shutdown** performs a cleaning, typically done at the end of the day. The instrument remains in stand-by mode with the Rinse.
- 3  **Escape** exits a function without executing it and goes to the previous screen.
- 4  **Mode** allows you to select CBC and CBC/DIFF modes.
- 5  **Print** allows you to print the last sample result, calibration results, laboratory limits, and so forth.
- 6  **Delete** deletes the entered information.
- 7  **Enter** executes a function or enters data.
- 8  **Range** selects the flagging range to be used.
- 9  **Cursor keys** move the cursor on the screen and allow you to scroll through the alphabet when entering information.
- 10  **Numeric keypad** allows you to enter numbers for dates, values, limits, sample IDs, and to select menu items.
- 11  **Period**. Allows you to enter the decimal number separator and to select/de-select software options.

Back Panel

Figure 1.4 shows the instrument's back panel.

Figure 1.4 Back Panel

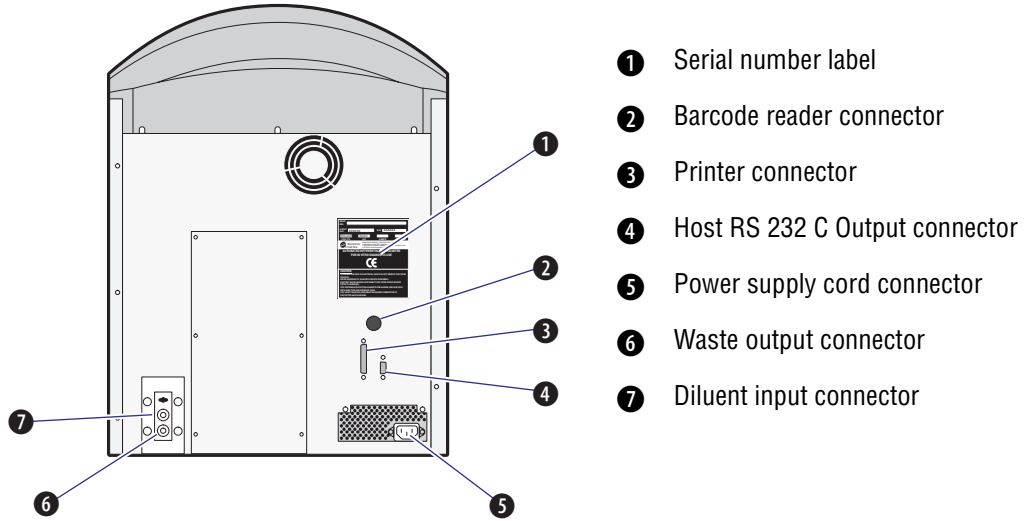

Warning and Caution Labels

Pay close attention to the labels on the instrument (Figure 1.5).

Figure 1.5 Warning and Caution Labels on the Instrument

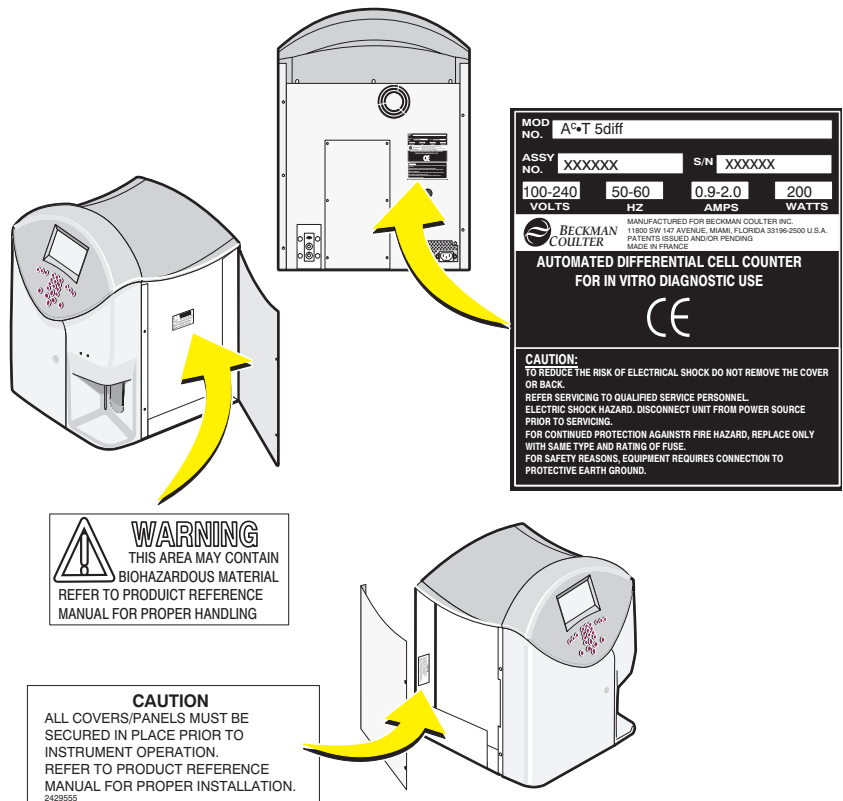

Modes

The instrument has two modes of analysis: CBC and CBC/DIFF. For information on the parameters of each mode, see **Parameters**.

Parameters

CBC Mode

Table 1.1 lists the 12 parameters analyzed in the CBC mode.

Table 1.1 CBC Parameters

Parameter	Definition
WBC	White Blood Cell or leukocyte count
RBC	Red Blood Cell or erythrocyte count
Hgb	Hemoglobin concentration
Hct	Hematocrit (relative volume of erythrocytes within the whole-blood sample)
MCV	Mean Corpuscular (erythrocyte) Volume
MCH	Mean Corpuscular (erythrocyte) Hemoglobin
MCHC	Mean Corpuscular (erythrocyte) Hemoglobin Concentration
RDW	Red Cell (erythrocyte) Distribution Width
Plt	Platelet or thrombocyte count
MPV	Mean Platelet Volume
PDW†	Platelet Distribution Width
Pct†	Plateletcrit

†Pct and PDW are derived parameters and are For Research Use Only. Not for use in diagnostic procedures.

CBC/DIFF Mode

Table 1.2 lists the 26 parameters analyzed in the CBC/DIFF mode:

Table 1.2 CBC/DIFF Parameters

Parameter	Definition
WBC	White Blood Cell or leukocyte count NE%: Neutrophil percentage NE#: Neutrophil number, LY%: Lymphocyte percentage, LY#: Lymphocyte number, MO%: Monocyte percentage, MO#: Monocyte number EO%: Eosinophil percentage, EO#: Eosinophil number, BA%: Basophil percentage, BA#: Basophil number IMM%†: Immature cell percentage IMM#†: Immature cell number ATL%†: Atypical lymphocyte percentage ATL#†: Atypical lymphocyte number
RBC	Red Blood Cell or erythrocyte count
Hgb	Hemoglobin concentration
Hct	Hematocrit (relative volume of erythrocytes within the whole-blood sample)
MCV	Mean Corpuscular (erythrocyte) Volume
MCH	Mean Corpuscular (erythrocyte) Hemoglobin
MCHC	Mean Corpuscular (erythrocyte) Hemoglobin Concentration
RDW	Red Cell (erythrocyte) Distribution Width
Plt	Platelet or thrombocyte count
MPV	Mean Platelet (thrombocyte) Volume
PDW†	Platelet Distribution Width
Pct†	Plateletcrit

†Derived parameters are For Research Use Only. Not for use in diagnostic procedures.

Features

Features of the instrument include automated calibration, one-button aspiration with probe wipe, 12- or 26-parameter analysis with histograms and DiffPlots, and alphanumeric or barcode patient sample identification.

Reports

Patient sample reports are printed based on your instrument setup.

1.2 CONTROLS AND CALIBRATORS

Cell Controls

A^C•T 5diff Control is available in three levels (low, normal, and high) to provide a stable reference control for use with this instrument.

Calibrator

A^C•T 5diff Cal Calibrator is a recommended alternative to the whole-blood reference method of calibration and is traceable to reference methods and materials. Use A^C•T 5diff Cal Calibrator to ensure accurate instrument measurements for WBC, RBC, Plt, Hct, and Hgb.

1.3 REAGENTS

Beckman Coulter recommends these reagents:

- A^C•T 5diff Diluent,
- A^C•T 5diff Fix,
- A^C•T 5diff WBC Lyse,
- A^C•T 5diff Hgb Lyse, and
- A^C•T 5diff Rinse.

These reagents are:

- Registered by the AFSSAPS (Agence Francaise de sécurité sanitaire des produits de santé) and are For In Vitro Diagnostic Use.
- Manufactured by Coulter Corporation, Inc., Miami, Florida USA, and distributed by Beckman Coulter France, SA 33 rue des Vanesses BP 50359 Villepinte 95942 Roissy CDG Cedex.

All stated performance characteristics in this manual are based on the use of the A^C•T 5diff analyzer with the above-referenced reagents. Refer to the reagent's bottle/container label for detailed information, such as stability, before using the reagent.

ATTENTION: The open container stability on the reagent labeling applies only to the reagent when connected to the instrument with approved reagent pickups and caps.

For information on handling reagent waste, see *Waste Handling Procedures* and *Replacing the Waste Container*.

A^C•T 5diff Diluent

WARNING Risk of explosion if sodium azide is not properly flushed down the drain with large volumes of water. Sodium azide preservative may form explosive compounds in metal drain lines. [See National Institute for Occupational Safety and Health Bulletin: Explosive Azide Hazards (8/16/76).] When disposing of reagents down the drain, flush with large volumes of water.

Used for counting and differentiating blood cells, A^C•T 5diff Diluent is clear and odorless. Composed of stabilized saline solution containing an organic buffer and less than 0.1% sodium azide, A^C•T 5diff Diluent:

- Dilutes whole-blood samples,
- Stabilizes cell membranes for accurate counting and sizing,
- Conducts aperture current, and
- Rinses instrument components between analyses.

Handle as indicated in this manual. To be used at ambient temperature from 18°C to 25°C up to the expiration date indicated on the packaging.

A^C•T 5diff Fix

Used to lyse erythrocytes, fix leukocytes, and differentially stain granules of monocytes, neutrophils, and eosinophils, A^C•T 5diff Fix is a deep blue aqueous solution that smells like alcohol. A^C•T 5diff Fix is composed of an alcohol solution containing propylene-glycol, a formic dye, buffers, alkaline salts, wetting agents, and an aldehyde preservative.

Handle as indicated in this manual. To be used at ambient temperature from 18°C to 25°C up to the expiration date indicated on the packaging.

A^C•T 5diff WBC Lyse

Used to lyse red blood cells for the leukocyte count and to differentiate poly-nuclear basophils, A^C•T 5diff WBC Lyse is a colorless, aqueous solution. It is composed of an acidic solution containing a lytic agent.

Handle as indicated in this manual. To be used at ambient temperature from 18°C to 25°C up to the expiration date indicated on the packaging.

A^C•T 5diff Hgb Lyse

Used to lyse blood cells and to determine hemoglobin concentration, A^C•T 5diff Hgb Lyse is a clear, aqueous solution and is composed of potassium cyanide at 0.035, a quarternary ammonium salt, and a saline phosphate buffer containing less than 0.1% sodium azide.

Handle as indicated in this manual. To be used at ambient temperature from 18°C to 25°C up to the expiration date indicated on the packaging.

A^C•T 5diff Rinse

Used as a rinsing agent, A^C•T 5diff Rinse is a transparent liquid composed of an enzymatic solution with proteolytic action.

Handle as indicated in this manual. To be used at ambient temperature from 18°C to 25°C up to the expiration date indicated on the packaging.

Waste Handling Procedures

Consult the material safety data sheets (MSDS) for additional reagent information. To order an MSDS, see **Heading 1.8, ORDERING MATERIAL SAFETY DATA SHEETS (MSDS)**.

Neutralizing the Waste and Treating for Biohazards

Do this procedure before capping the waste container for disposal.

WARNING Risk of personal injury if waste is not neutralized before the waste container is capped. Non-neutralized waste contents may produce gas, which can build up pressure in a capped container. Neutralize waste contents after removing the waste container and before capping it for disposal.

- 1 For 20L of waste liquid, add the following to the waste container:
 - a. 50mL of Sodium Hydroxide solution 200g/L to prevent gas from forming.
 - b. 250mL of Sodium Hypochlorite solution (12% available chlorine) to treat waste for biohazards.
-

- 2 Cap the waste container and firmly tighten the cap to prevent waste contents from escaping.
-

- 3 Dispose of the waste container according to your laboratory's guidelines.

Handling Expired Reagents

Do this procedure to eliminate cyanides from expired A^C•T 5diff Hgb Lyse.

- 1** For 1L of reagent, add:
 - a. 50mL of Sodium Hydroxide solution 200g/L.
 - b. 100mL of freshly prepared Ammonium Persulfate solution 500g/L or 50mL of Sodium Hydroxide solution 500g/L.
 - c. 500mL of Sodium Hypochlorite solution (30% available chlorine).
-

- 2** Dispose of expired reagents according to your laboratory's guidelines.

1.4 PRINTER

Use the printer supplied or approved by Beckman Coulter.

1.5 RANGES

The instrument provides the ability to define three separate sets of flagging criteria.

- Range 1 selects Patient Range 1 and Action Range 1.
- Range 2 selects Patient Range 2 and Action Range 2.
- Range 3 selects Patient Range 3 and Action Range 3.

This means that if you select Range 2, the sample results will be reported and flagged according to Patient Range 2 and Action Range 2.

Remember these range associations when establishing your laboratory limits and when selecting a range for analysis.

1.6 WORKING WITH THE SOFTWARE

When working with the instrument's software, be sure you understand the basics of:

- Moving the Cursor,
- Selecting Menu Items,
- Erasing Saved Text, and
- Selecting/De-selecting Software Fields.

Moving the Cursor

To move the software cursor, press the appropriate cursor key: , , , or .

Selecting Menu Items

There are two ways to select a menu item:

- Press the number on the numeric keypad that corresponds to the menu item you want to select.
For example, to select **CALIBRATION** from the Main Menu, press **2** at the numeric keypad.

OR

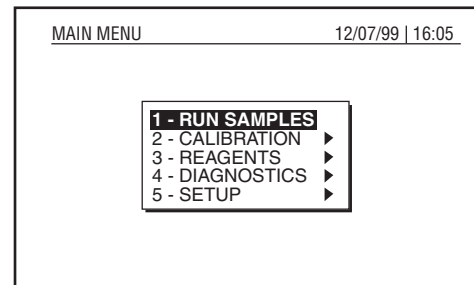

- Highlight the menu item by pressing

 or , then press .

For example, to select **CALIBRATION** from the Main Menu,

press  and .

Erasing Saved Text

There may be times when you need to erase saved text.

- 1** Move the cursor to the line of text where you want to delete information.
-

- 2** Press  .
The cursor becomes a flashing underscore, which means you can now edit the field.
-

- 3** Move the underscore to the character you want to delete.
-

- 4** Press  to backspace and delete.
-

- 5** Press  to save the changes.

Selecting/De-selecting Software Fields

Some software screens allow you to select (activate) or de-select (deactivate) certain software features.

- 1** Move the cursor to the desired field.
-

2 Press .

For example, 7001 is selected on the Autocalibration screen shown here.

Note:

= selected.

= not selected.

AUTOCALIBRATION		02/27/00 16:05	
7001	<input checked="" type="checkbox"/>	LOT #	CX294
OP2	<input type="checkbox"/>	EXP. DATE	04/05/00
OP3	<input type="checkbox"/>		
OP4	<input type="checkbox"/>		
TARGET VALUES			
WBC	10.4	RBC	4.40
HCT	36.7	PLT	255
		HGB	13.6
<input type="button" value="CONTINUE"/>			

1.7 PRESENTING SAMPLES TUBES (OR VIALS) AND STARTING ANALYSIS

Some procedures in this manual require you to present a tube (or vial) to the instrument and start analysis. The following information describes how.

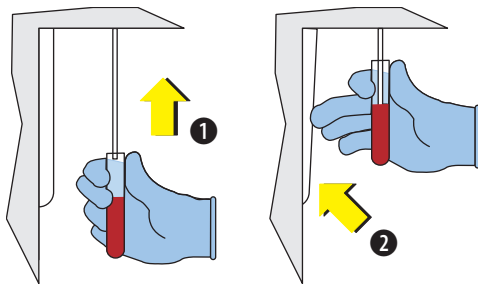

- 1 Present the tube (or vial) to the aspirate probe.
- 2 Ensure that the probe is well inside the tube (or vial) contents, and press the aspirate switch.

During aspiration, the red and green LEDs flash.

- When the red LED remains illuminated, remove the tube (or vial) from the probe.
- When the green LED remains illuminated, the instrument is ready for the next analysis.

1.8 ORDERING MATERIAL SAFETY DATA SHEETS (MSDS)

To obtain an MSDS for reagents used on the AC•T 5diff analyzer:

1. In the USA, either call Beckman Coulter Customer Operations (800.526.7694) or write:

Beckman Coulter, Inc.
Attn: MSDS Requests
P.O. Box 169015
Miami, FL 33116-9015
2. Outside the USA, contact a Beckman Coulter representative.

USE AND FUNCTION

ORDERING MATERIAL SAFETY DATA SHEETS (MSDS)

2.1 OVERVIEW

The A^C•T 5diff analyzer is a fully automated hematology analyzer providing a complete WBC five-part differential, which is determined simultaneously by the A^{CV} (Absorbance Cytochemistry and Volume) Technology and WBC/BASO methodologies.

The A^{CV} Technology uses absorbance, cytochemistry, and focused flow impedance. The WBC/BASO methodology uses differential lysis, impedance technology, and differential thresholds. See Table 2.1.

Table 2.1 A^C•T 5diff Analyzer: Measurement Technologies

Fluid Dynamics	Technology	Measurements	Output
Dual Focused Flow	A ^{CV} Technology	Light absorbance of cytochemically-stained cells	Lymphocytes, monocytes, neutrophils, eosinophils, immature cells, and atypical lymphocytes
Volume aperture	Differential lysis using the Coulter Principle	Volume and count	WBC count, basophil percentage, and basophil count
Volume aperture	Coulter Principle	Volume and count	RBC count, platelet count, and hematocrit

2.2 MEASUREMENT PRINCIPLES

Coulter Principle

In the A^C•T 5diff analyzer, the Coulter Principle¹ is used to analyze the final RBC/Plt dilution and the WBC/BASO dilution. This electronic method of counting and sizing particles is based on the fact that cells, which are poor conductors of electricity, will interrupt a current flow. The impedance variation generated by the passage of non-conductive cells through a small, calibrated aperture is used to determine the count (number of particles) and size (volume) of the particles passing through the aperture within a given time period.

Aperture Sensor System

The RBC/Plt aperture sensor system determines the cell count and size of red blood cells and platelets. The WBC/BASO aperture sensor system determines the cell count and size of white blood cells. Additionally, the differentiation between basophils and other white blood cells is related to the A^C•T 5diff WBC Lyse-specific lytic action on the white blood cells in WBC/BASO bath.

To sense particles using the Coulter Principle (Figure 2.1), a current flow is established so changes in that flow can be monitored. In this sensing system, an electrode is placed on each side of the aperture. The most visible electrode is referred to as the counting head. These electrodes are the conductive metallic housings attached to the front of the RBC and WBC/BASO baths. The second electrode, referred to as the bath electrode, is not as conspicuous. This electrode is located inside the bath. The aperture is located between the counting head and the bath electrode.

Figure 2.1 Coulter Principle

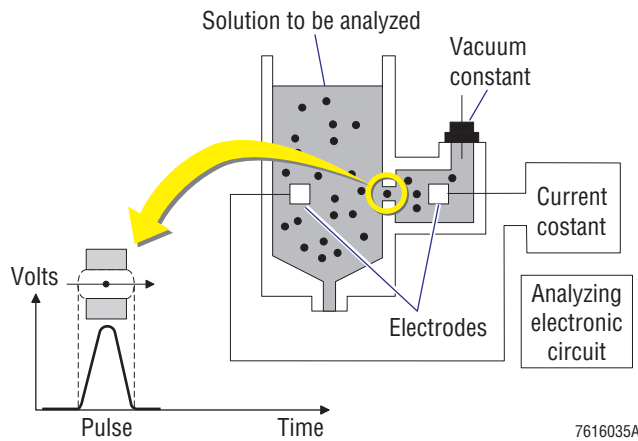

When the count circuit is activated and an electronically conductive reagent is in the RBC or WBC/BASO bath, an electric current continuously passes through the aperture. Current moving between the two electrodes establishes the electronic flow through the aperture.

Once a sample is aspirated, an aliquot of that aspirated sample is diluted with reagent (an electrolyte) and is delivered to the RBC or WBC/BASO bath using tangential flow, which ensures proper mixing of the dilution. When the cells suspended in the conductive reagent are pulled through a calibrated aperture, the electrical resistance between the two electrodes increases proportionately with the cell volume (Figure 2.1).

The resistance creates a pulse that is sensed and counted as a particle by the instrument. The amount of resistance (amplitude of each pulse) is directly related to the size of the particle that produced it.

The generated pulses have a very low voltage, which the amplification circuit increases so that the electronic system can better analyze the pulses and eliminate the background noise.

Applying the Coulter Principle

The A^C•T 5diff analyzer makes several dilutions of an aspirated whole-blood sample. The RBC/Plt dilution begins in the First Dilution/Hgb bath but is actually analyzed in the RBC bath. The final dilution in the RBC bath is used to determine the cell count and size of red blood cells and platelets.

The WBC/BASO aperture sensor system is directly responsible for determining the cell count and size of white blood cells. The differentiation between basophils and other white blood cells is also related to the A^C•T 5diff WBC Lyse-specific lytic action on these white blood cells.

Thresholds, which are electronically set size limits, exclude unwanted particles, such as debris, from the analysis. Particles above the threshold are analyzed, and particles below the threshold are excluded.

2.3 ACV TECHNOLOGY

In the DIFF bath, 25 μ L of whole blood is mixed with 1,000 μ L of A^C•T 5diff Fix reagent for 12 seconds, then stabilized with 1,000 μ L of A^C•T 5diff Diluent for an additional 3 seconds. This reaction lyses the red blood cells, preserves the leukocytes at their original size, and differentially stains the lymphocytes, monocytes, neutrophils, and eosinophils, with eosinophils staining most intensely. The instrument maintains the reagents and reaction at a regulated temperature of 35°C (95°F).

The lymphocytes, monocytes, neutrophils, and eosinophils each have a unique nuclear and morphologic structure and staining intensity, and therefore, absorb light differently. Each stained cell is individually focused by the Dual Focused Flow (DFF) system and transported through the flowcell using sample pressure and diluent sheath flow.

Dual Focused Flow (DFF)

DFF (Figure 2.2) fluid dynamics uses a hydrodynamic focusing process to focus individual cells or particles in a stream of diluent. The focused sample stream of the A^C•T 5diff analyzer is about 40 μ m in diameter.

DFF uses the sheath fluid to surround and force cells suspended in diluent to pass one at a time through the center of the flowcell. The first sheath flow focuses the sample through the impedance aperture. The second sheath flow maintains the focused flow of cells as they exit the aperture into the optical flowcell. Hydrodynamic focusing in the flowcell enables accurate and rapid cell-by-cell measurements on a large number of individual cells.

Figure 2.2 Dual Focused Flow Process

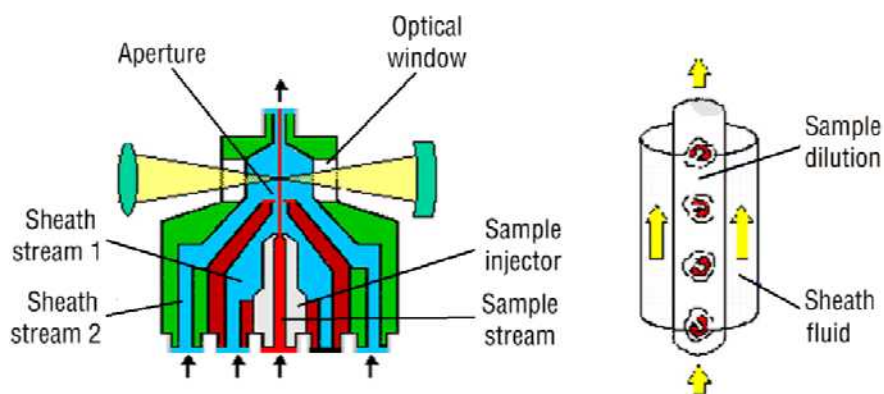

Flowcell

Sequential analyses for cell volume (impedance) and light absorbance are performed in the flowcell. A total of 72 μ L of sample is injected through the flowcell for 15 seconds. The flowcell incorporates a 60 μ m aperture for cellular volume analysis and a 42 μ m measurement area for light absorbance.

Focused Flow Impedance

Focused flow impedance technology measures the electrical resistance of a cell as it passes through the aperture in the flowcell. The change in resistance is directly proportional to the volume of the cell.

Absorbance Cytochemistry

As a cell passes through the optical portion of the flowcell, light is scattered in all directions. A sensor detects only forward scattered light. The optical measurement is derived as a function of the amount of light lost due to diffraction and absorbance, as compared to full transmission when no cell is present.

The collected signals are converted into voltage pulses and are processed. The magnitude of the voltage pulses are proportional to the physical and chemical characteristics of the cells being analyzed. Light absorbance is related to cellular contents (granularity, nuclear content, and so forth) after cytochemical staining. These measurements provide the information for lymphocytes, monocytes, neutrophils, and eosinophils, and their precursors.

Signal Processing

The signals from the flowcell aperture and from the optical measurement are correlated by a window of time. The optical pulse must be detected within 100 to 300 microseconds of the impedance pulse, otherwise, the signal is rejected.

The output signals from the focused flow impedance and the light absorbance measurements are combined to define the WBC differential population clusters. See Figure 2.3.

Figure 2.3 Signal Processing

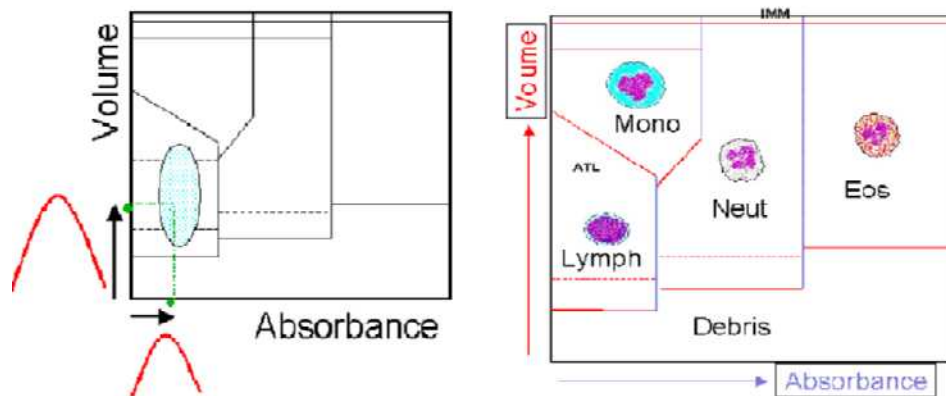

Thresholds

Most of the population partition thresholds are fixed and give the limits of the morphological normality of leukocytes. Changes in the morphology of a population are expressed on the DiffPlot by a shifting of the corresponding population. Volume and absorbance thresholds are used to detect shifting populations.

2.4 WBC/BASO METHODOLOGY

In the WBC/BASO bath, 10 μ L of whole blood is mixed with 2,000 μ L of A^C•T 5diff WBC Lyse reagent. This reaction lyses the red blood cells and specifically differentiates between the basophils and other leukocytes by volume. The instrument maintains the reagents and reaction at a regulated temperature of 35°C (95°F).

Using a constant vacuum, the instrument then pulls the sample through an 80 μ m aperture. As each cell passes through the aperture, a pulse is generated proportional to the cellular volume. The total leukocyte count and basophil percentage are determined by specific thresholds on the WBC/BASO histogram (Figure 2.4.).

Figure 2.4 BASO Thresholds

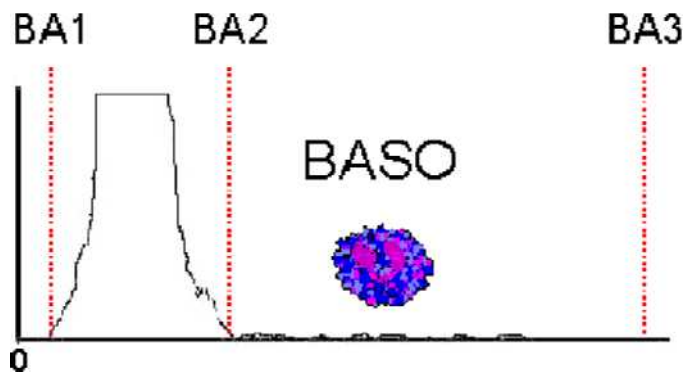

2.5 SAMPLE ANALYSIS OVERVIEW

Aspiration

When the sample probe is immersed in a whole-blood sample and the aspirate switch is pressed, sample is pulled from the tube into the sample probe. Depending on the selected mode of operation, the A^C•T 5diff analyzer aspirates either 30 μ L (CBC mode) or 53 μ L (CBC/DIFF mode) of sample.

The volume of sample aspirated into the sample probe is sufficient to make all the dilutions needed to develop parameter results in the selected mode of operation. The aspirated sample is then partitioned as it is distributed into the designated baths.

Figure 2.5 shows the sample partitioning that occurs in the CBC/DIFF mode. Notice there are three aliquots of the aspirated whole-blood sample that will be used to make dilutions.

Figure 2.6 shows the sample partitioning that occurs in the CBC mode. Notice there are only two aliquots of the aspirated whole-blood sample that will be used to make dilutions in this mode of operation. (The DIFF aliquot is not needed in the CBC mode.)

To ensure sample integrity, the sample aliquot at the tip of the probe is never used to make a dilution; it is discarded into the Rinse bath.

Figure 2.5 Sample Partitions Inside the Probe - CBC/DIFF Mode

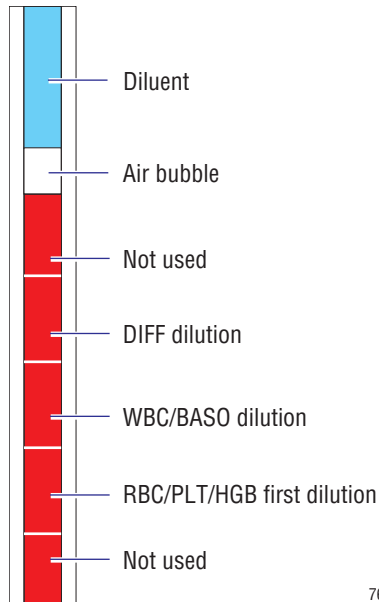

7616001A

Figure 2.6 Sample Partitions Inside the Probe - CBC Mode

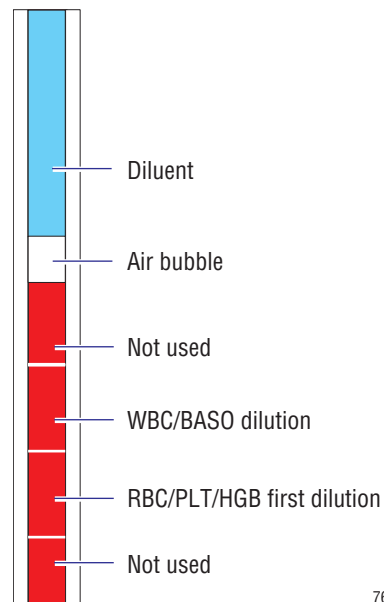

7616056A

Dilution

Using the Sequential Dilution System (SDS) technique, the instrument makes a series of dilutions in a series of baths (Figure 2.7).

Figure 2.7 Bath Assembly

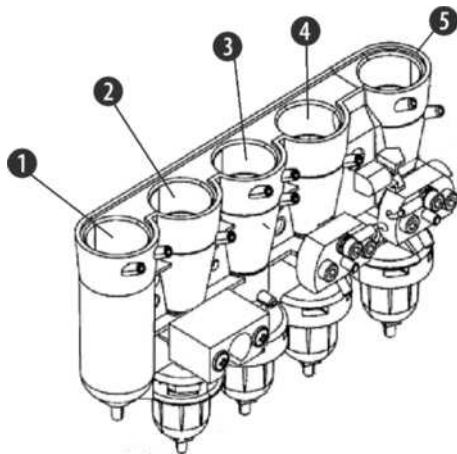

- ① Rinse bath
- ② First Dilution/Hgb bath
- ③ DIFF bath
- ④ RBC bath
- ⑤ WBC/BASO bath

CBC Mode

After aspiration in the CBC mode, aliquots of the whole-blood sample are distributed as follows (Figure 2.5):

- The 3 μ L sample aliquot at the tip of the probe is discarded into the Rinse bath as the exterior of the sample probe is rinsed, ensuring sample integrity.
- 10 μ L of sample is delivered to the First Dilution/Hgb bath for use in preparing the primary RBC/Plt dilution and for measuring the Hgb value.
- 10 μ L of sample is delivered to the WBC/BASO bath for the WBC/BASO count.
- 7 μ L of remaining sample is discarded into the Rinse bath.

CBC/DIFF Mode

After aspiration in the CBC/DIFF mode, aliquots of the whole-blood sample are distributed as follows (Figure 2.6):

- The 3 μ L sample aliquot at the tip of the probe is discarded into the Rinse bath as the exterior of the sample probe is rinsed, ensuring sample integrity.
- 10 μ L of sample is delivered to the First Dilution/Hgb bath for use in preparing the primary RBC/Plt dilution and for measuring the Hgb value.
- 10 μ L of sample is delivered to the WBC/BASO bath for the WBC/BASO count.
- 25 μ L of sample is delivered to the DIFF bath for development of the DiffPlot.
- 5 μ L of remaining sample is discarded into the Rinse bath.

Delivery

In the CBC and the CBC/DIFF modes, each aliquotted sample is delivered to its appropriate bath using a tangential flow (Figure 2.8) of reagent, which mixes the diluted sample and minimizes viscosity problems.

Figure 2.8 Sample Delivery Using Tangential Flow

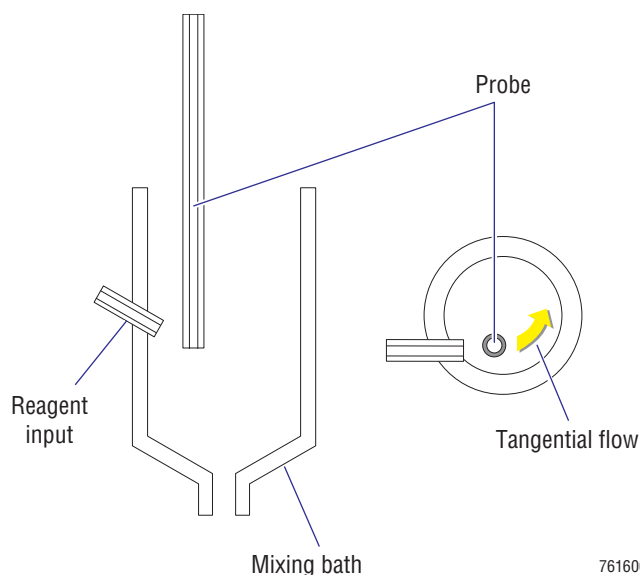

7616002A

2.6 SAMPLE ANALYSIS

RBC and Platelet Analysis

The RBC/Plt dilution analyzes red blood cells and platelets. This dilution is prepared in two stages – the primary (first) dilution and the secondary (last) dilution.

The primary dilution is made in the First Dilution/Hgb bath, and the secondary dilution is made in the RBC bath (Figure 2.9). Table 2.2 summarizes the technical characteristics required to obtain RBC and Platelet results.

Figure 2.9 Bath Assembly

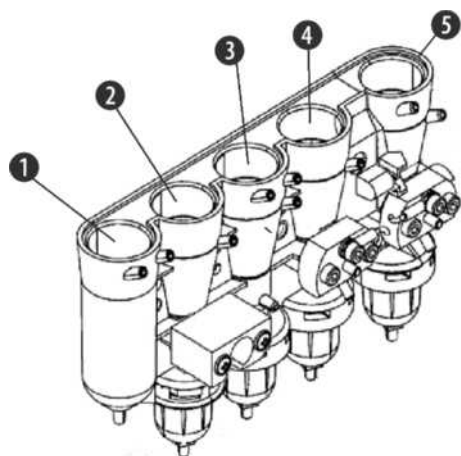

- ① Rinse bath
- ② First Dilution/Hgb bath
- ③ DIFF bath
- ④ RBC bath
- ⑤ WBC/BASO bath

Table 2.2 Technical Characteristics for Obtaining RBC and Platelet Counts

Dilution Characteristics	
Primary Dilution for RBC and Plt:	
Initial volume of whole-blood	10 μ L
Volume AC•T 5diff diluent	1700 μ L
Primary dilution ratio	1:170
Secondary Dilution for RBC and Plt:	
Volume of primary dilution	42.5 μ L
Volume AC•T 5diff diluent	2500 μ L
Secondary dilution ratio	1:58.8
Final dilution for RBC and Plt results	1:170 x 1:58.8 = 1:10,000
Reaction temperature	35°C (95°F)
Measurement Characteristics	
Method of analysis	Coulter Principle
Aperture diameter	50 μ m
Count vacuum	200mb (5.9in. Hg)
Count period	2x5 seconds

Parameter Results Obtained from the RBC/Plt Dilution

This final 1:10,000 RBC/Plt dilution is used to:

- Determine the RBC count,
- Develop the RBC histogram, which is needed to obtain the Hct, MCV, and RDW results,
- Determine Plt count,
- Develop the Plt histogram, which is needed to obtain MPV, Pct, and PDW results.

Hgb Measurement

Hemoglobin is determined from the dilution in the First Dilution/Hgb bath (Figure 2.9). This dilution is prepared in two stages – the primary (first) dilution and the secondary (last) dilution.

The primary dilution is made and 42.5µL of that dilution is removed for making the RBC/Plt dilution. A^C•T 5diff Hgb Lyse and additional Diluent are added to make the final 1:250 dilution.

The Hgb concentration is based on the transmittance of light through the optical part of the First Dilution/Hgb bath using a spectrophotometric technique at a wavelength of 550nm. The transmittance of the sample dilution is compared to the transmittance of a reagent blank. The system calculates the Hgb using the blank and sample readings.

Table 2.3 summarizes the technical characteristics required for measuring hemoglobin.

Table 2.3 Technical Characteristics for the Measurement of the Hemoglobin

Dilution Characteristics	
Volume of whole-blood	10µL
Volume A ^C •T 5diff diluent	1700µL
Preliminary dilution ratio	1:170
Volume of the 1:170 dilution removed (for making the RBC/Plt dilution)	42.5µL
Additional volume of A ^C •T 5diff diluent	400µL
Volume of A ^C •T 5diff Hgb Lyse	400µL
Final dilution for Hgb determination	1:250
Reaction temperature	35°C (95°F)
Measurement Characteristics	
Method of analysis	Spectrophotometry
Wavelength	550nm

WBC Count and Differential

The WBC count is determined twice using two different methodologies:

- The reference WBC count is the count obtained in the WBC/BASO bath (Figure 2.10). The WBC count and the BASO count are determined simultaneously.
- A second WBC count is determined in the flowcell during acquisition of the DiffPlot. The dilution analyzed in the flowcell is prepared in the DIFF bath (Figure 2.10).

The WBC counts from the two methodologies are compared, and, if they exceed the defined limits, will be flagged.

Figure 2.10 Bath Assembly

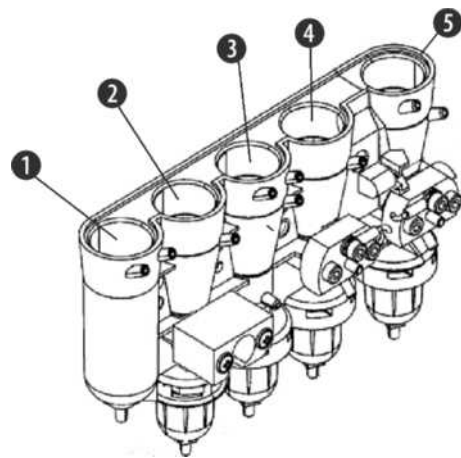

- ❶ Rinse bath
- ❷ First Dilution/Hgb bath
- ❸ DIFF bath
- ❹ RBC bath
- ❺ WBC/BASO bath

Table 2.4 summarizes the technical characteristics required to obtain WBC and BASO results.

Table 2.4 Characteristics Required to Obtain WBC/BASO Results

Dilution Characteristics	
Volume of whole-blood	10 μ L
Volume AC•T 5diff WBC Lyse	2,000 μ L
Dilution ratio	1:200
Reaction temperature	35°C (95°F)
Measurement Characteristics	
Method of analysis	Coulter Principle
Aperture diameter	80 μ m
Count vacuum	200mb (5.9in. Hg)
Count period	2x6 seconds

Parameter Results Obtained from the WBC/BASO Dilution

The final 1:200 dilution is used to:

- Determine the WBC count, and
- Develop the WBC/BASO histogram, which is needed to obtain the BASO count.

Differential

Twenty-five microliters (25 μ L) of whole blood is delivered to the DIFF bath in a flow of A^C•T 5diff Fix reagent, which lyses the red blood cells, stabilizes the WBC in their native forms, and differentially stains the lymphocytes, monocytes, neutrophils, and eosinophils, with eosinophils staining most intensely.

The solution is then stabilized with Diluent for three seconds and transferred to the measuring bath. See Figure 2.11. Each cell is measured in absorbance (cytochemistry) and resistivity (volume).

Figure 2.11 Flowcell Operation

2) Second focused flow for optical detection

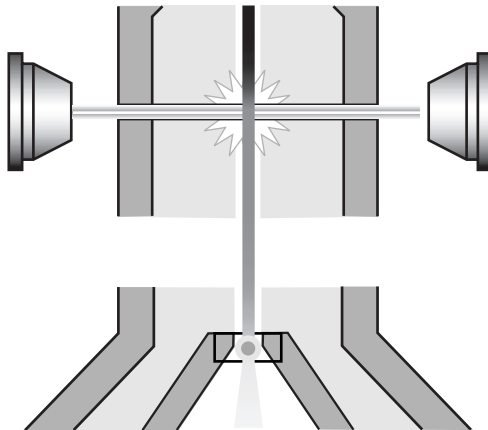

1) Primary focused flow for impedance

Table 2.5 summarizes the technical characteristics required for acquisition of the DiffPlot.

Table 2.5 Technical Characteristics for Acquisition of the DiffPlot

Dilution Characteristics	
Volume of whole-blood	25µL
Volume AC•T 5diff Fix	1000µL
Volume AC•T 5diff Diluent	1000µL
Final dilution ratio	1:80
Reaction temperature	35°C (95°F)
Incubation duration	12 seconds
Measurement Characteristics	
Method of analysis	Impedance with hydrofocus
Aperture diameter	60µm
Diameter of the flow	42µm
Injection duration	15 seconds
Data accumulated	12 seconds
Volume injected	72µL

Parameter Results Obtained from the DIFF Dilution

From these measurements, a DiffPlot is developed with optical transmission (absorbance) on the X-axis and volume on the Y-axis. Figure 2.12 shows the DiffPlot regions.

From the DiffPlot, four out of five leukocyte (white blood cell) populations are determined: lymphocytes, monocytes, neutrophils, and eosinophils.

In a typical whole-blood sample, the basophil population (determined in the WBC/BASO bath) is very small compared to the other four white blood cell populations.

Figure 2.12 DiffPlot Regions

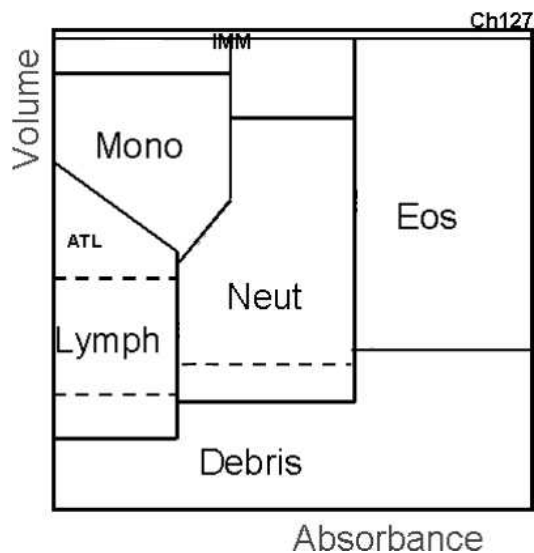

Dilution Summary

Table 2.6 summarizes the dilution characteristics required to obtain CBC and CBC/DIFF parameter results.

Table 2.6 Summary of Dilutions

Technical Characteristics	Whole-Blood Volume	Reagent(s)	Reagent Volume	Dilution Ratio	Reaction Temperature
WBC Count and BASO Count (in the WBC/BASO bath)	10µL	AC•T 5diff WBC Lyse	2,000µL	Final 1:200	35°C (95°F)
Differential Acquisition with Differential WBC Count (in the DIFF bath)	25µL	AC•T 5diff Fix AC•T 5diff Diluent	1,000µL 1,000µL	Final 1:80	35°C (95°F)
Hgb Measurement (in the First Dilution/Hgb bath)	10µL	AC•T 5diff Diluent After removing 42.5 µL of the 1:170 dilution: AC•T 5diff Diluent AC•T 5diff Hgb Lyse	1700µL 400µL 400µL	Preliminary 1:170 Final 1:250	35°C (95°F)
RBC and Plt Count (in the RBC bath) Note: The primary dilution (1:170) is made in the First Dilution/Hgb bath.	42.5µL of the 1:170 dilution (from the First Dilution/Hgb bath)	AC•T 5diff Diluent	2,500µL	Secondary 1:58.8 1:170 x 1:58.8 = Final 1:10,000	35°C (95°F)

2.7 PARAMETER DEVELOPMENT

RBC Parameters

RBC Count

The AC•T 5diff hematology analyzer uses duplicate counting criteria, voting criteria, and proprietary flagging information to confirm the parameter result prior to reporting it. To obtain an RBC count result, the instrument compares the data from the two 5-second count periods then votes and rejects any questionable data.

RBC count = Number of cells counted per unit volume x Calibration coefficient

The RBC count is displayed and printed as: RBC = N x 10⁶ cells/µL.

(Note: cells/µL is the US unit format. Other formats are available. See **Heading A.7, REPORTING UNIT SELECTION.**)

RBC Histogram

In addition to being counted, red blood cells are categorized according to size (from 30 fL to 300 fL) by a 256-channel pulse-height analyzer. The pulse-height analyzer uses a number of thresholds to sort the particles into several size (volume) categories and to develop a size distribution curve of the particles. The RBC distribution curve shows cells in their native size. Figure 2.13 is an example of an RBC histogram with a normal RBC size distribution.

Figure 2.13 Typical RBC Histogram

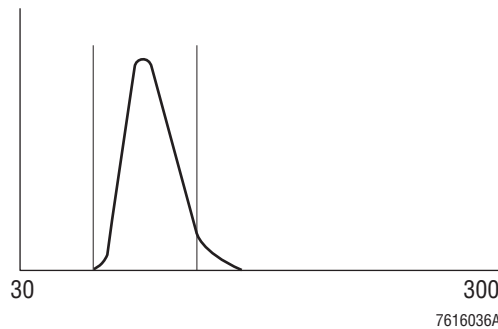

Parameter Results Obtained Using the RBC Histogram

- Hct measurement: The height of the pulse generated by the passage of a cell through the aperture is directly proportional to the volume of the analyzed red blood cell. The hematocrit (Hct) is the sum of all the digitized pulses. Hct is displayed and printed as % (percentage). (Note: % is the US unit format. Other formats are available. See **Heading A.7, REPORTING UNIT SELECTION.**)
- MCV calculation: The MCV (Mean Cell Volume) is calculated using the Hct and the RBC count. The MCV is displayed and printed in femtoliters (fL). (Note: fL is the US unit format. Other formats are available. See **Heading A.7, REPORTING UNIT SELECTION.**)
- RDW calculation: The RDW (Red cell Distribution Width) is an index of the variation or spread in the size of the red blood cells. The study of the RBC distribution detects erythrocyte anomalies linked to anisocytosis and enables the clinician to follow the evolution of the width of the curve relative to the cell number and average volume. Displayed and printed as a percentage, RDW is calculated using the standard deviation (SD) of the RBC population and the MCV.

$$RDW(\%) = \frac{K \ SD}{MCV}$$

where:

K = System constant

SD = Calculated standard deviation based on the red cell distribution

MCV = Mean Cell Volume of the red cells

MCH and MCHC Calculations

- MCH calculation: The MCH (Mean Cell Hemoglobin) is calculated from the Hgb value and the RBC count and describes the average weight of hemoglobin in a red cell. The calculation for MCH is:

$$\text{MCH (pg)} = \frac{\text{Hgb}}{\text{RBC}} \times 10$$

(Note: pg is the US unit format. Other formats are available. See **Heading A.7, REPORTING UNIT SELECTION.**)

- MCHC calculation: The MCHC (Mean Cell Hemoglobin Concentration) is calculated using the Hgb and Hct values and describes the average concentration of hemoglobin in the red blood cells. The calculation for MCHC is:

$$\text{MCHC (g/dL)} = \frac{\text{Hgb}}{\text{Hct}} \times 100$$

(Note: g/dL is the US unit format. Other formats are available. See **Heading A.7, REPORTING UNIT SELECTION.**)

Plt Parameters

Platelet counting and sizing is also done in the RBC bath. Thresholds separate the platelet pulses, which are much smaller, from the red blood cell pulses. Platelets are also categorized according to size by a 256-channel pulse-height analyzer. A pulse-height analyzer uses a number of thresholds to sort the particles into several size (volume) categories and to develop a size distribution curve of the particles. The Plt distribution curve shows cells in their native size. Figure 2.14 is an example of a Plt histogram with a normal Plt size distribution.

Figure 2.14 Typical Plt Histogram

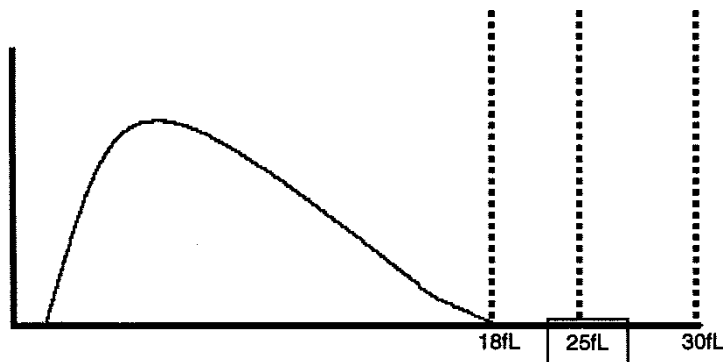

Interference on the Lower End of the Platelet Distribution Curve

Particles that are approximately platelet size can interfere with the platelet histogram and count. Small particles, such as micro-bubbles or dust, can interfere at the low end. If the number of pulses in the 2 to 3 fL region is higher than the predefined limits, an *SCL* flag appears to alert the operator that a significant number of small cells or interference, such as micro-bubbles, are present.

Microcytic Interferences on the Upper End of the Platelet Distribution Curve

Microcytic red blood cells can intrude at the upper end of the platelet distribution curve. If the sample contains microcytes, the AC•T 5diff analyzer may be able to successfully eliminate the influence of this interference by repositioning the variable threshold and excluding the microcytes.

Parameter Results Obtained Using the Plt Histogram

- **Plt Count:** The AC•T 5diff hematology analyzer uses duplicate counting criteria, voting criteria, and proprietary flagging information to confirm the parameter result prior to reporting it. To obtain a Plt count result, the instrument compares the data from the two 5-second count periods then votes and rejects any questionable data.

Plt count = Number of cells counted per unit volume x Calibration coefficient.

Plt count is displayed and printed as Plt = $N \times 10^3$ cells/ μL .

(Note: μL is the US unit format. Other formats are available. See **Heading A.7, REPORTING UNIT SELECTION.**)

- **MPV Measurement:** The MPV (Mean Platelet Volume) is measured directly from analysis of the platelet distribution curve. The MPV is displayed and printed in femtoliters (fL).
- **Pct Calculation:** The Pct (plateletcrit) is calculated according to the formula:

$$\text{Pct}\% = \frac{\text{Plt} (10^3/\mu\text{L}) \times \text{MPV} (\text{fL})}{10,000}$$

- **PDW Calculation:** PDW (Platelet Distribution Width) is calculated from the Plt histogram as the width of the curve between S1 and S2.

As shown in Figure 2.15, S1 and S2 are placed so that:

- ▶ 15% of the platelets occur between 2fL and S1.
- ▶ 15% of the platelets occur between S2 and the variable upper threshold.
- ▶ The PDW result is determined on the platelets between S1 and S2.

Figure 2.15 Area of the Plt Histogram Used to Determine the PDW Parameter Result

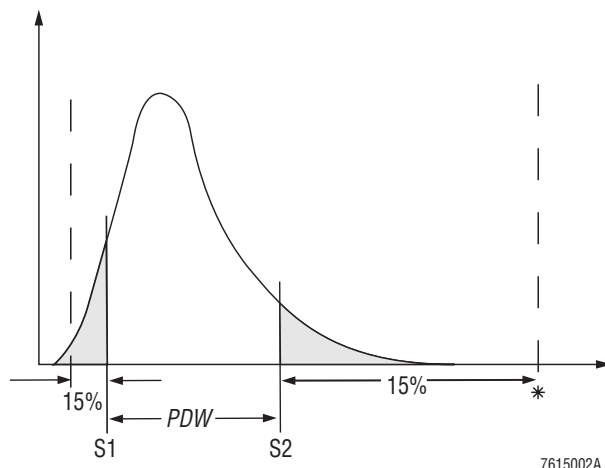

7615002A

Hgb Determination

The hemoglobin (Hgb) released by the lysis of the red blood cells combines with the potassium cyanide to form a stable cyanmethemoglobin compound.

This compound is measured through the optical part of the First Dilution/Hgb bath using a spectrophotometric technique at a wavelength of 550nm. Transmittance of the sample dilution is compared with the transmittance of a reagent blank. The system calculates the Hgb using both the blank and sample readings.

The final Hgb result represents: absorbance value obtained x coefficient of calibration.

Hgb is displayed and printed as Hgb = N g/dL.

(Note: g/dL is the US unit format. Other formats are available. See **Heading A.7, REPORTING UNIT SELECTION.**)

WBC Count, BASO Count, and DiffPlot Development

WBC Count

The AC•T 5diff hematology analyzer uses duplicate counting criteria, voting criteria, and proprietary flagging information to confirm the parameter result prior to reporting it. To obtain a WBC count result, the instrument compares the data from the two 5-second count periods then votes and rejects any questionable data. This is the reference WBC count, which is reported.

A second WBC count is determined in the flowcell during acquisition of the DiffPlot.

WBC count: number of cells per unit volume x coefficient of calibration.

BASO Count

Differentiation between basophils and other leukocytes is obtained by means of the AC•T 5diff WBC Lyse-specific lytic action. See Figure 2.16.

In Figure 2.16, basophils are located in the area between the thresholds labeled ② and ③. One hundred percent (100%) of the leukocytes is represented by the total number of nucleated particles plus the basophils within the area between the thresholds labeled ① and ③.

The basophil percentage is calculated from the number of particles existing in the area between the thresholds labeled ② and ③ (Figure 2.16).

Figure 2.16 Areas Used to Determine WBC and BASO Parameter Results

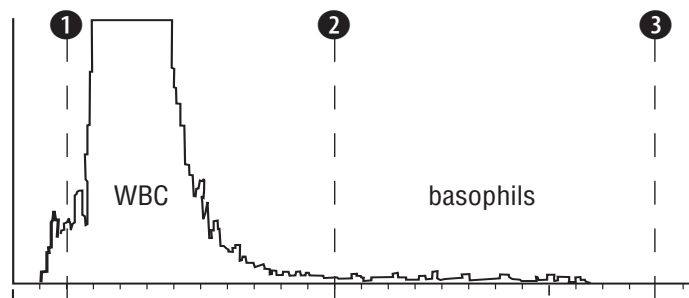

BASO count: number of cells per unit volume x coefficient of calibration in percentage relative to the number of counted cells (BASO plus WBC nuclei).

$$\text{BASO count} = \frac{\text{BASO}\%}{\text{WBC}\%} \times \text{WBC count}$$

DiffPlot Development

The DiffPlot analysis on the A^C•T 5diff hematology analyzer is based on three essential principles:

- Dual Focused Flow (DFF) fluid dynamics, which is a process by which individual cells or particles are focused in a stream of diluent (hydrodynamic focusing).
- The volume measurement (Coulter Principle).
- The measurement of transmitted light with zero degree (0°) angle, which permits a response proportional to the internal structure of each cell and its absorbance.

From these measurements, a DiffPlot is developed with optical transmission (absorbance) on the X-axis and volume on the Y-axis. See Figure 2.17.

Figure 2.17 DiffPlot Regions

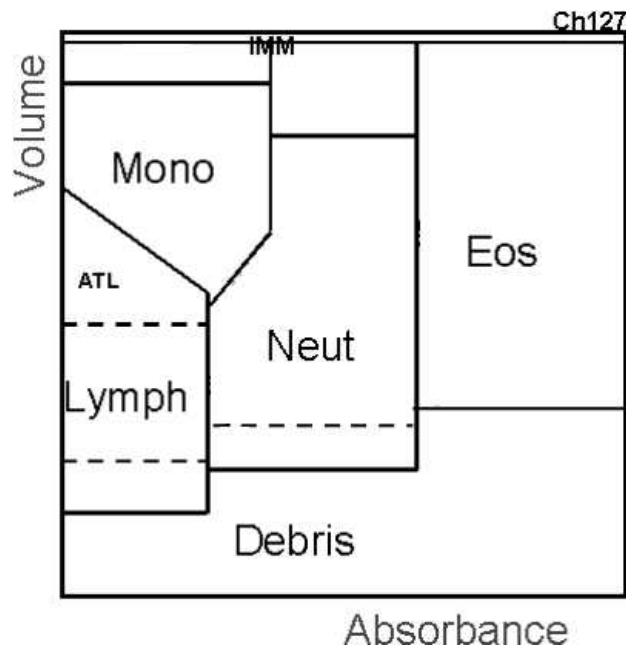

The study of the DiffPlot permits the clear differentiation of four out of five leukocyte populations. In a typical whole-blood sample, the basophil population is very small when compared with the other four white cell populations.

Table 2.7 defines the DiffPlot regions. Table 2.8 defines immature white blood cells.

Table 2.7 DiffPlot Regions Defined

Region	Definition
Neutrophil (Neut)	Neutrophils, with their cytoplasmic granules and segmented nuclei, scatter light according to their morphological complexity. A hypersegmented neutrophil gives an increased optical response when compared to a young neutrophil population. The higher the complexity of the cell, the further to the right they appear in the DiffPlot (Figure 2.17).
Lymphocyte (Lymph)	<p>Lymphocytes, typically being small with regular shape are smaller in volume and lower in absorbance than the other cells, and are positioned in the lower region of the DiffPlot (Figure 2.17). Normal lymphocyte populations typically have a homogeneous volume with a Gaussian (bell-shaped) distribution.</p> <p>Large lymphocytes, reactive lymphoid forms, stimulated lymphocytes and plasma cells are found in the upper portion of the lymphocyte region (Figure 2.17).</p> <p>The lower area of the lymphocyte zone is normally empty; however, when small lymphocytes are present, a population may exist in this area (Figure 2.17).</p> <p>The presence of platelet aggregates is indicated by a distribution pattern that moves from the DiffPlot origin into the lymphocyte region (Figure 2.17).</p> <p>NRBC cytoplasmic membranes lyse like those of mature erythrocytes. The small nuclei that remain appear in the debris and small lymphocyte regions (Figure 2.17).</p>
Monocyte (Mono)	<p>Monocytes are typically large cells with a kidney-shaped nucleus and agranular cytoplasm. These cells neither scatter nor absorb large amounts of light and, therefore, are positioned in the lower end of the absorbance axis. Due to their size, the monocytes are clearly positioned high on the volume axis (Figure 2.17).</p> <p>Very large monocytes may be found in the IMM (immature cell) region.</p>
Eosinophil (Eos)	With the reagent action, eosinophils are the most intensely stained for optical separation. Due to the staining and their size, the eosinophils will show higher absorbance than the neutrophils, but will be of similar volume (Figure 2.17).
Debris	Platelets and debris from erythrocyte lysis represent the background debris population located in the lower region of the DiffPlot.

Table 2.8 Immature White Blood Cells

Immature Cell Type	Definition
Immature Granulocytes	<p>Immature granulocytes are detected by their larger volume and by the presence of granules that increase the intensity of the scattered light.</p> <p>Due to their increased volume and similar absorbance, promyelocytes, myelocytes, and metamyelocytes are located above the neutrophil population and are typically counted as IMM cells. IMM cells are included in the reported neutrophil value.</p>
Band Cells	<p>Band cells are typically larger or of similar size to the neutrophils; however, due to their low level of cellular complexity, they absorb less light. As a result, band cells tend to appear in the region between the neutrophils and the monocytes.</p>
Blast Cells	<p>Blast cells are generally larger than monocytes and have similar absorbance. When blast cells are present, they are generally located above the monocytes, which means they will be included in the IMM cell count.</p> <p>Small blasts will be located between the normal lymphocyte and monocyte populations.</p>

3.1 INSTRUMENT SPECIFICATIONS

Dimensions and Weight

See Figure 3.1.

WARNING Risk of operator injury if only one person lifts the instrument. The instrument has no lifting handles, and it weighs more than one person should lift. Therefore, to prevent injury, at least two people following necessary safety precautions should lift the instrument together.

Figure 3.1 Instrument Dimensions and Weight

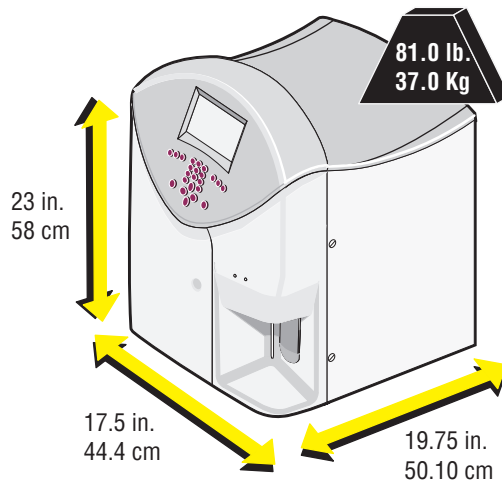

Power

Supply

From 100 Vac to 240 Vac. From 50 Hz to 60 Hz.

Consumption

200 watts maximum.

Installation Category

The instrument is designed to be safe for transient voltages according to Installation Category II and Pollution Degree 2.

Grounding Requirements

To protect against electrical shock, the wall ground (earth) plug must be correctly connected to the laboratory grounding electricity installation.

Temperature, Ambient Operating

The ambient operating temperature is 16°C to 34°C (61°F to 93°F). If you keep the instrument at a temperature less than 10°C (50°F), allow the instrument to remain at the ambient operating temperature for one hour before use.

Altitude Range

The instrument can be operated at any altitude up to 3,000 meters (9,800 feet).

Recommended Location

Place the instrument on a clean, level bench, allowing at least 20cm (8 in.) of space behind the instrument for ventilation.

Electromagnetic Environment Check

The instrument produces less than the acceptable level of electromagnetic interference when properly placed. Electromagnetic interferences are limited to levels that allow the correct operation of other instruments conforming to their placement.

If there is a problem, ensure that the instrument is not placed near electromagnetic fields or short wave emissions (such as radar, X-ray machines, scanners, and so forth).

Recommended Reagents

Beckman Coulter recommends these reagents:

- A^C•T 5diff Diluent,
- A^C•T 5diff Fix,
- A^C•T 5diff WBC Lyse,
- A^C•T 5diff Hgb Lyse, and
- A^C•T 5diff Rinse.

See **Heading 1.3, REAGENTS** for additional information about these reagents.

Recommended Controls

A^C•T 5diff Control is the recommended control. See **Heading 1.2, CONTROLS AND CALIBRATORS** for additional information.

Recommended Calibrator

A^C•T 5diff Cal Calibrator is the recommended calibrator. See **Heading 1.2, CONTROLS AND CALIBRATORS** for additional information.

Recommended Anticoagulant

The recommended anticoagulant is K₃EDTA with the proper proportion of blood to anticoagulant as specified by the tube manufacturer.

Sample Volume Aspirated

- 30 µL of whole blood is aspirated in the CBC mode.
- 53 µL of whole blood is aspirated in the CBC/DIFF mode.

Dilution Ratios

WBC/BASO: 1/200
DIFF: 1/80
RBC/Plt: 1/10,000
Hgb: 1/250

Throughput

The instrument can process up to 60 samples per hour in either mode – CBC or CBC/DIFF.

The instrument achieves nominal throughput when used in a routine laboratory environment with samples having normal hematology parameters. Depending on sample mix and workflow conditions, slightly higher or lower throughput might be observed.

Sample Stability

Sample stability is based on an average of 20 clinical normal and abnormal whole-blood samples.

- CBC parameters are stable up to 48 hours at room temperature.
- DIFF parameters are stable up to 24 hours at room temperature.

Sample Identification

You can enter a sample ID using the instrument’s control panel, setup the instrument to autonumber the IDs, or scan the tube’s barcode label with the optional hand-held barcode reader.

Output

The instrument can transmit startup, sample, and control data to a host computer. The Sample Results screen shows the sample identification number, sample results, and any result flags.

The instrument prints a report (Figure 3.2).

Figure 3.2 Sample Report

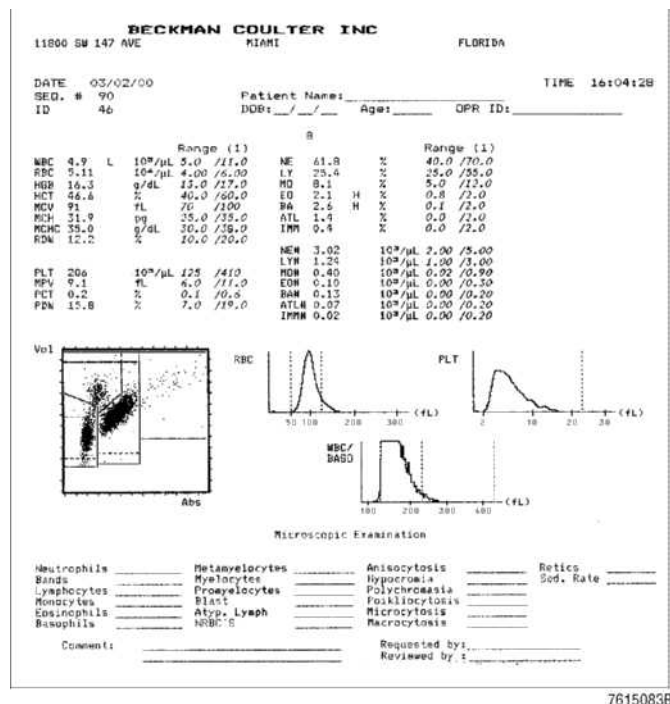

Measurements and Computation

- Impedance for WBC, Plt, RBC, and BA.
- Photometry for Hgb using cyanmethemoglobin method with 550nm diode light source.
- Impedance and light absorbance for NE, LY, MO, EO, ATL, and IMM.
- Computation from stored data that was directly measured for Hct, MCV, MCH, MCHC, RDW, MPV, Pct, and PDW.

Counting Aperture Diameters

WBC/BASO: 80 µm
 DIFF: 60 µm
 RBC/Plt: 50 µm

Reagent Consumption

Table 3.1 shows the instrument's reagent consumption by cycle.

Table 3.1 Reagent Consumption by Cycle in mL

Cycle	Reagent					Approximate Duration
	Diluent	WBC Lyse	Rinse	Fix	Hgb Lyse	
CBC	20.5	2.1	0.9	–	0.4	60 sec
CBC/DIFF	25.6	2.1	0.9	1.0	0.4	60 sec
Startup†	62.0	2.1	3.7	1.0	1.4	3 min 40 sec
Shutdown	25.5	–	14	–	1.0	2 min 45 sec
Prime Diluent	35.5	–	–	–	–	2 min 30 sec
Prime Rinse	–	–	25.8	–	–	1 min 20 sec
Prime Fix	–	–	–	25.8	–	1 min 30 sec
Prime WBC Lyse	–	25.8	–	–	–	1 min 20 sec
Prime Hgb Lyse	2.5	–	–	–	4.2	1 min
Prime All Reagents	23.7	16.0	16.0	16.0	4.2	3 min 20 sec
Autoclean	12.5	–	6.0	–	–	1 min 35 sec
System Reset Cycle	24.0	–	1.4	–	1.0	1 min 25 sec

*†For one background count only. The maximum is three.
 – indicates not applicable.*

Environmental Protection

Removal and recycling of this instrument must be done by a properly qualified laboratory in accordance with local legislation.

3.2 PERFORMANCE SPECIFICATIONS

The stated performance specifications apply to an instrument that has been properly maintained as indicated in *Chapter 8, DIAGNOSTICS*, and one that uses only the recommended reagents listed in *Recommended Reagents*.

Reproducibility

Reproducibility (Table 3.2) is based on 20 consecutive replicate runs from one normal, fresh whole-blood sample without flags.

Table 3.2 Reproducibility Specifications

Parameter	CV%	Test Level
WBC	<2.0%	10.0x10 ³ /μL
RBC	<2.0%	5.00x10 ⁶ /μL
Hgb	<1.0%	15.0 g/dL
Hct	<2.0%	45.0%
Plt	<5.0%	300.0x10 ³ /μL

Linearity

Linearity (Table 3.3) is assessed on serially diluted material. Each dilution is analyzed four times.

Table 3.3 Linearity Specifications

Parameter	Units	Linearity Range	Difference (Whichever is Greater)
WBC	10 ³ /μL	0.4 to 90.0	±0.2 or ±3%
RBC	10 ⁶ /μL	0.23 to 7.70	±0.05 or ±2%
Plt	10 ³ /μL	4 to 1,000	±10 or ±6%
Hgb	g/dL	0 to 22.9	±0.3 or ±2%
Hct	%	1.8 to 55.9 56.0 to 63.8	±2 or ±3% ±5 or ±5%

Accuracy

Accuracy (Table 3.4) is assessed by duplicate analysis of clinical specimens when compared to an automated hematology analyzer that has been properly calibrated and maintained according to the manufacturer's recommendation.

Table 3.4 Accuracy Specifications

Parameter	Correlation r
WBC	>0.95
RBC	>0.95
Hgb	>0.95

Table 3.4 Accuracy Specifications (Continued)

Parameter	Correlation r
Hct	>0.95
Plt	>0.95

Carryover

Carryover (Table 3.5) is assessed by analyzing whole blood with high values followed by a whole blood sample with low values. Each sample is run consecutively in triplicate.

Carryover is calculated as follows:

$$\text{Carryover} = \frac{\text{Low 1} - \text{Low 3}}{\text{High 1} - \text{Low 3}} \times 100$$

Table 3.5 Carryover Specifications

Parameter	Carryover
WBC	<2.0%
RBC	<2.0%
Plt	<2.0%
Hgb	<2.0%

Reportable Range

The reportable range (Table 3.6) is the range of results that the instrument displays, prints, and transmits. Results between the linear range and the reportable range will be flagged.

Table 3.6 Reportable Range

Parameter	Units	Reportable Range
WBC	10 ³ /μL	0.0 – 100.0
RBC	10 ⁶ /μL	0.00 – 10.00
Plt	10 ³ /μL	0.0 – 1500.0
Hct	%	0.0 – 80.0
Hgb	g/dL	0.0 - 30.0

3.3 PERFORMANCE CHARACTERISTICS

Reproducibility

Reproducibility was measured twice to show precision at two levels of WBC counts – one relatively lower than the other:

- Table 3.7 shows the precision values based on 20 replicate samples that were analyzed consecutively on the same instrument from one normal, fresh, whole-blood sample with a low, normal WBC and without flags.
- Table 3.8 shows the precision values based on 20 replicate samples analyzed consecutively on the same instrument from one normal, fresh, whole-blood sample with a high, normal WBC and without flags.

Table 3.7 Reproducibility Characteristics From a Normal Sample with a Low Normal WBC Count

Parameter	Mean	Standard Deviation (SD)	CV%
WBC	6.40	0.09	1.42
RBC	4.39	0.03	0.59
Hgb	13.80	0.06	0.44
Hct	38.60	0.25	0.66
Plt	288.40	7.86	2.73
NE%	60.8	0.73	1.21
LY%	27.3	0.55	2.02
MO%	8.10	0.49	6.09
EO%	3.30	0.32	9.64
BA%	0.60	0.12	20.21

Table 3.8 Reproducibility Characteristics From a Normal Sample with a High Normal WBC Count

Parameter	Mean	Standard Deviation (SD)	CV%
WBC	12.50	0.18	1.41
RBC	5.17	0.03	0.61
Hgb	16.80	0.06	0.33
Hct	48.90	0.32	0.64
Plt	173.60	4.05	2.33
NE%	85.20	0.31	0.36
LY%	7.70	0.37	4.80
MO%	5.30	0.17	3.30
EO%	0.90	0.14	15.10
BA%	0.90	0.10	10.59

Accuracy

Accuracy (Table 3.9) for the CBC and DIFF parameters was defined as agreement between the comparator instrument and the AC•T 5diff analyzer using clinical specimens covering the expected range of performance.

Table 3.9 Accuracy Characteristics

Parameter	Correlation r
WBC	0.99
RBC	0.99
Hgb	0.99
Hct	0.99
Plt	0.98
NE%	0.99
LY%	0.99
MO%	0.88
EO%	0.98

Carryover

Carryover (Table 3.10) was assessed by analyzing whole blood with high values followed by a whole-blood sample with low values. Each sample was run consecutively in triplicate.

Carryover is calculated as follows:

$$\text{Carryover} = \frac{\text{Low 1} - \text{Low 3}}{\text{High 1} - \text{Low 3}} \times 100$$

Table 3.10 Carryover Characteristics

Parameter	Units	Low Level	High Level	Carryover %
WBC	10 ³ /μL	1.5	54.6	0.00%
RBC	10 ⁶ /μL	2.0	8.1	0.16%
Plt	10 ³ /μL	35.5	818.0	0.45%
Hgb	g/dL	6.3	25.4	0.26%

3.4 LIMITATIONS

Maintenance

Failure to properly execute the maintenance procedures in **Chapter 8, DIAGNOSTICS** may compromise the instrument's reliability.

Blood Specimens

If any abnormal test result (including flagged results or results outside the normal range) occur, use reference methods or other standard laboratory procedures to verify the results. For additional information, see **Heading 3.5, INTERFERING SUBSTANCES**.

3.5 INTERFERING SUBSTANCES

Table 3.11 shows a list of known limitations of automated blood cell counters that use impedance and light absorbance as measurement principles.

Table 3.11 Interfering Substances

Parameter	Interfering Substance
WBC	<p>Unlysed RBCs: In rare instances, the erythrocytes in the blood sample may not completely lyse and are detected on the WBC histogram with an *WBC flag or as an elevated baseline on the lymphocytes. Non-lysed RBCs will cause a falsely elevated WBC count.</p> <p>Multiple myeloma: The precipitation of proteins in multiple myeloma patients may cause elevated WBC counts.</p> <p>Leukemia: A very low WBC count may result in this disease state due to the possible fragility of the leukocytes; some of these cells may be destroyed during counting. WBC fragments will also interfere with the WBC DIFF parameters.</p> <p>Chemotherapy: Cytotoxic and immunosuppressive drugs may increase the fragility of the leukocytes, which may cause low WBC counts.</p> <p>Cryoglobulins: Increased levels of cryoglobulin that may be associated with myeloma, carcinoma, leukemia, macroglobulinemia, lymphoproliferative disorders, metastatic tumors, autoimmune disorders, infections, aneurysm, pregnancy, thromboembolic phenomena, diabetes, and so forth, which can elevate the WBC, RBC, or Plt counts and the Hgb concentration. The specimen must be warmed to 37°C (99°F) in a water bath for 30 minutes and reanalyzed immediately (analyzer or manual method).</p> <p>Agglutinated WBCs: Leukoagglutination.</p>
RBC†	<p>Agglutinated RBCs: May cause a falsely low RBC count. Blood samples containing the agglutinated RBCs may be suspected by elevated MCH and MCHC values and shown by examination of the stained blood film.</p> <p>Cold agglutinins: IgM immunoglobulins elevated in cold agglutinin disease may lower RBC and Plt counts and increase MCV.</p>
Hgb	<p>Turbidity of the blood sample: Any number of physiologic and/or therapeutic factors may produce falsely elevated Hgb results. To obtain accurate Hgb results when increased turbidity of the blood sample occurs, determine the cause of the turbidity and follow the appropriate method below:</p> <ul style="list-style-type: none"> • Elevated WBC: An extremely elevated WBC will cause excessive light scatter. If this occurs: <ol style="list-style-type: none"> 1. Use the reference (manual) methods. 2. Centrifuge the diluted sample. 3. Measure the supernatant fluid with a spectrophotometer. • Elevated lipids: Elevated lipids in the blood sample will give the plasma a milky appearance. This condition can occur with hyperlipidemia, hyperproteinemia (as in gammopathies), and hyperbilirubinemia. Accurate hemoglobin determinations can be achieved by using reference (manual) methods and a plasma bank. • Increased turbidity: This may be seen in cases where the RBCs are resistant to lysing. This condition will cause a falsely elevated Hgb result but may be detected by observing the abnormal MCH, MCHC values, and the increased baseline on the leading edge of the WBC histogram. Erroneous Hgb results will cause the results of MCH and MCHC to also be erroneous. • Fetal bloods: The mixing of fetal and maternal blood may produce a falsely elevated Hgb value.

Table 3.11 Interfering Substances (Continued)

Parameter	Interfering Substance
Hct	RBC agglutination: May produce erroneous Hct and MCV values. RBC agglutination may be detected by observing abnormal MCH and MCHC values, and by examining the stained blood film. Use the manual method to obtain an accurate Hct value.
MCV	RBC agglutination: May produce an erroneous MCV value. RBC agglutination may be detected by observing abnormal MCH and MCHC values, and by examining the stained blood film. Use the manual method to obtain an accurate MCV value. Excessive numbers of large platelets: This condition and/or the presence of an excessively high WBC count may interfere with the accurate determination of the MCV value. Carefully examine the stained blood film to detect the problem.
MCH	MCH is determined according to the Hgb value and the RBC count, which means that anything listed as an interfering substance for Hgb and/or RBC will impact MCH and may cause erroneous MCH values.
MCHC	MCHC is determined according to the Hgb and Hct values, which means that anything listed as an interfering substance for Hgb and/or Hct will impact MCHC and may cause erroneous MCHC values.
RDW	RDW is determined according to the RBC count and may be impacted by the following conditions: <ul style="list-style-type: none"> • Agglutinated RBCs: May cause a falsely low RBC count and erroneous RDWs. Blood samples containing the agglutinated RBC may be detected by observing abnormal MCH and MCHC values and by examining the stained blood film. • Nutritional deficiency or blood transfusion: May cause elevated RDW results due to iron, cobalamin, and/or folate deficiencies.
Plt	Very small RBCs (microcytes), RBC fragments (schizocytes), and WBC fragments: May interfere with the proper counting of platelets and cause elevated Plt counts. Agglutinated RBCs: May trap platelets, causing an erroneously low Plt count. The presence of agglutinated RBCs may be detected by observing abnormal MCH and MCHC values and by examining the stained blood film. Excessive numbers of large platelets: May cause an erroneously low Plt count since these large platelets may exceed the upper threshold for the Plt parameter are not counted. Chemotherapy: Cytotoxic and immunosuppressive drugs may increase the fragility of these cells, which may cause low Plt counts. Use the manual (reference) method to obtain an accurate Plt count. Hemolysis: Hemolysed specimens contain RBC stroma which may elevate Plt count. ACD (acid-citrate-dextrose) blood: Blood anticoagulated with ACD may contain clumped Plt which could depress the Plt count. Plt Agglutination: Clumped platelets may cause a decreased Plt count and/or elevated WBC count; *WBC, SL, and SL1 flags may be generated. Reanalyze the specimen as follows: <ol style="list-style-type: none"> 1. Recollect the specimen in sodium citrate anticoagulant to prevent platelet agglutination. 2. Reanalyze the specimen for only the Plt count. 3. Correct the final Plt result for the effect of the sodium citrate dilution.

Table 3.11 Interfering Substances (Continued)

Parameter	Interfering Substance
MPV [†]	<p>Giant platelets: May exceed the upper threshold of the Plt parameter and may not be counted as platelets. Consequently, these larger platelets will not be included in the instrument's calculation of MPV.</p> <p>Very small RBCs (microcytes), RBC fragments (schizocytes), and WBC fragments: May interfere with the proper counting of platelets.</p> <p>Agglutinated RBCs: May trap platelets, causing an erroneous MPV result. You may be able to detect the presence of agglutinated RBCs by observing abnormal MCH and MCHC values and by examining the stained blood film.</p> <p>Chemotherapy: May also affect the sizing of platelets.</p>
NE#, NE%	The neutrophil count is derived from the WBC count. The presence of excessive eosinophils, metamyelocytes, myelocytes, promyelocytes, blasts, and plasma cells may interfere with an accurate neutrophil count.
LY#, LY%	The lymphocyte count is derived from the WBC count. The presence of erythroblasts, certain parasites, and RBCs that are resistant to lysis may interfere with an accurate LY count. Interfering substances pertaining to WBC also pertain to the LY# and LY%.
MO#, MO%	The mononuclear cell count absolute is derived from the WBC count. The presence of large lymphocytes, atypical lymphocytes, blasts, and an excessive number of basophils may interfere with an accurate monocyte count. Interfering substances pertaining to WBC also pertain to the MO# and MO%.
EO#, EO%	The eosinophil cell count is derived from the WBC count. The presence of abnormal granules (degranulated areas, toxic granules, and so forth) may interfere with the eosinophil count. Interfering substances pertaining to WBC also pertain to the EO# and EO%.
BA#, BA%	The basophil cell count is derived from the WBC count. Interfering substances pertaining to WBC also pertain to the BA# and BA%.

[†]The RBC dilution contains all formed elements in the blood, erythrocytes, leukocytes, and platelets. During the counting of the RBCs, platelets are not counted if their size falls below the RBC minimum threshold.

[‡]Blood samples collected in EDTA will not maintain a stable MPV because platelets swell depending on the time post-collection and storage temperature.

SPECIFICATIONS/CHARACTERISTICS
INTERFERING SUBSTANCES

4.1 DEFINITIONS

Warnings

Anything that can cause user injury is considered a hazard and is noted in the text as WARNING. Warnings appear where needed throughout this manual.

Cautions

Anything that can cause instrument damage is considered a caution and is noted in the text as CAUTION. Cautions appear where needed throughout this manual.

Importants

Anything that can cause misleading results or data corruption is considered an important and is noted in the text as IMPORTANT. Importants appear where needed throughout this manual.

Attention

An ATTENTION provides additional information to be considered when performing a procedure.

4.2 SAFETY PRECAUTIONS

Electronic

WARNING Risk of personal injury from electronic shock. Electronic components can shock and injure you. To prevent possible injury or shock, do not tamper with the instrument and do not remove any components (covers, doors, panels, and so on) unless otherwise instructed within this document.

Biological

WARNING Risk of personal injury or contamination. If you do not properly shield yourself while using or servicing the instrument, you may become injured or contaminated. To prevent possible injury or biological contamination, you must wear proper laboratory attire, including gloves, a laboratory coat, and eye protection.

Use care when working with pathogenic materials. Be sure that you have a procedure available to decontaminate the instrument, provide ventilation, and dispose of waste liquid and sharps. Refer to the following publications for further guidance on decontamination.



- Biohazards Safety Guide, 1974, National Institute of Health.
- Classifications of Etiological Agents on the Basis of Hazards, 3d ed., June 1974, Center for Disease Control, U.S. Public Health Service.

Moving Parts

WARNING Risk of personal injury. Operating the instrument with doors and/or covers open can cause personal injury. When you operate the instrument, be sure all covers and doors are closed.

4.3 OPERATIONAL HAZARDS

Safety symbols alert you to potentially dangerous conditions. These symbols, together with text, apply to specific procedures and appear as needed throughout this manual.

Symbol	Warning Condition	Action
	Biohazard. Consider all materials (specimens, reagents, controls, calibrators, and so forth) and areas these materials come into contact with as being potentially infectious.	Wear standard laboratory attire and follow safe laboratory procedures when handling any material in the laboratory.
	Probe hazard. The probe is sharp and may contain biohazardous materials, such as controls and calibrators.	Avoid any unnecessary contact with the probe and probe area.
	Electrical shock hazard. Possibility of electrical shock when instrument is plugged into the power source.	Before continuing, unplug the AC•T 5diff analyzer from the electrical outlet.

5.1 BEFORE ANALYSIS

Do the following procedures:

- **Waste Container Level Check,**
- **Printer Check,**
- **Startup,**
- **Specimen Collection and Mixing,** and
- **Running Cell Controls to Verify Calibration.**

Waste Container Level Check

At the beginning of each day, check the waste container to determine if it needs to be replaced. If so, do **Replacing the Waste Container.**

Printer Check

At the beginning of each day, be sure the printer is ready to print.

-
- 1** Be sure there is an adequate paper supply in the printer.
 - If so, go to step 2.
 - If not, add paper according to the printer's user manual.
-
- 2** Press the printer's ON/OFF switch until the control LEDs are on.
-
- 3** Be sure the printer is properly configured. See **Heading A.10, PRINTER CONFIGURATION** for details.

Startup

Startup During Power Up

When you turn on the instrument, Startup is automatically done if the unit has been put in Shutdown. If you want to do Startup again, do **Startup After Power Up**.

1 Turn the instrument on.

The instrument performs the Startup routine (a rinse cycle followed by a background count, which is an analysis cycle on reagent without any blood specimen).

Upon completion of the Startup cycle, the instrument displays and prints the results.



IMPORTANT Risk of erroneous results if the instrument's heating devices have not reached 35°C (95°F). Allow the instrument to warm to 35°C (95°F). This may take several minutes to do. Keep the right door closed.

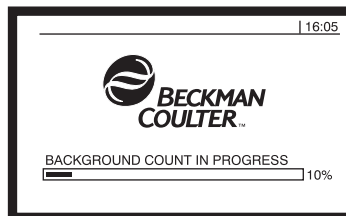

2 Review the Startup results.

- If Startup passed, go to **Specimen Collection and Mixing**.
- If Startup failed, go to step 3.

-
- 3** If the background counts are not within acceptable limits after the first Startup cycle, the instrument automatically performs Startup up to two more times. If Startup fails after the third attempt, a *STARTUP FAILED* message appears on the screen and on the report for every cycle.

Note: The background count limits are:

$$\text{WBC} = 0.3 \times 10^3/\mu\text{L}^3$$

$$\text{RBC} = 0.03 \times 10^6/\mu\text{L}^3$$

$$\text{Hgb} = 0.3 \text{ g/dL}$$

$$\text{Plt} = 7.0 \times 10^3/\mu\text{L}^3$$

- a. Do **Startup After Power Up**.
- b. If Startup continues to fail, contact a Beckman Coulter representative.

If the system determines that there is insufficient reagent to complete the day's work, a *REAGENT LOW LEVEL* message appears.

- Identify the low reagent and change it according to the procedures in **Replacing Reagents**.

OR

- Continue and change the reagent when the specific reagent low message is displayed.

Startup After Power Up

Do this procedure if you want to run Startup after the instrument has already gone through the initial Startup routine at power up.

-
- 1** Press .

-
- 2** Review the Startup results.
- If Startup passed, go to ***Specimen Collection and Mixing***.
 - If Startup failed, go to step 3.

-
- 3** If the background counts are not within acceptable limits after the first Startup cycle, the instrument automatically performs Startup up to two more times. If Startup fails after the third attempt, a *STARTUP FAILED* message appears on the screen and on the report for every cycle.

Note: The background count limits are:

$$\text{WBC} = 0.3 \times 10^3/\mu\text{L}^3$$

$$\text{RBC} = 0.03 \times 10^6/\mu\text{L}^3$$

$$\text{Hgb} = 0.3 \text{ g/dL}$$

$$\text{Plt} = 7.0 \times 10^3/\mu\text{L}^3$$

- a. Do ***Startup After Power Up***.
- b. If Startup continues to fail, contact a Beckman Coulter representative.

If the system determines that there is insufficient reagent to complete the day's work, a *REAGENT LOW LEVEL* message appears.

- Identify the low reagent and change it according to ***Replacing Reagents***.
- OR
- Continue and change the reagent when the specific reagent low message is displayed.

Specimen Collection and Mixing



IMPORTANT Risk of erroneous results if the specimen collection tube is not filled to the quantity required by the tube manufacturer. Fill the specimen collection tube as required.

- 1 Using K₃EDTA as the anticoagulant, collect the required amount of venous specimen according to the tube manufacturer's requirements.

Note: You can collect blood into a microcontainer with a minimum volume of 100µL for analysis on this instrument.

- 2 Mix the blood specimen gently and thoroughly before analysis.

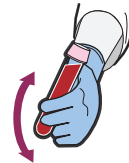

Running Cell Controls to Verify Calibration

Before analyzing patient samples, ensure that the system is within acceptable operating limits by analyzing three levels (low, normal, and high) of cell control material.

The cell control for the A^C•T 5diff hematology analyzer is A^C•T 5diff Control.



- 1 Press  to select the desired analysis mode (CBC or CBC/DIFF). The mode selected appears on the screen.

-
- 2** Enter the cell control number as the sample ID.



- 3** Mix each control according to the instructions in the cell control package insert.
Inspect the vial's contents to ensure that all cells are uniformly distributed; if not, repeat this step.



- 4** Present the cell control vial to the sample probe, and press the aspirate switch.
The LEDs flash during sample aspiration.

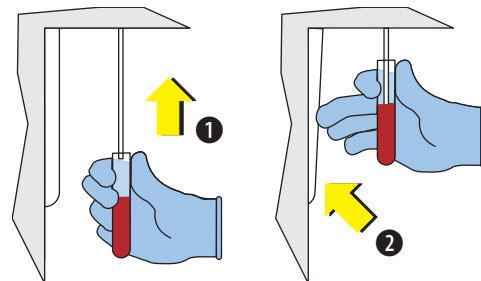

-
- 5** When the red LED illuminates, remove the cell control tube from the probe.
When the green LED remains illuminated, the instrument is ready for the next analysis.

6 Repeat steps 1 through 5 until you have run all three levels of cell control.

7 Review the control results to ensure they are within the acceptable ranges.

- If so, then you are ready to analyze patient samples. See **Heading 5.2, ANALYSIS**.
- If not, go to step 8.

8 When control results are not within the acceptable ranges:

- a. Rerun the control. If results are still outside the acceptable ranges, do step b.
- b. Clean the system. See **Diluter System**.
- c. Rerun the control. If the results are still outside the acceptable ranges, do step d.
- d. Analyze a new cell control vial. If the results are still outside the acceptable ranges, do step e.
- e. Recalibrate the system. See **Heading 7.3, AUTO-CALIBRATION** and rerun the control.
 - If the results are still outside the acceptable ranges, contact a Beckman Coulter representative.
 - If your cell control results are within the acceptable ranges, you are ready to analyze patient samples in **Heading 5.2, ANALYSIS**.

5.2 ANALYSIS

Running Whole-Blood Samples



- 1 Verify that the sample ID in the Next ID field is correct.
 - If so, go to step 2.
 - If not, enter the sample ID as instructed in **Heading 5.5, ENTERING THE SAMPLE IDENTIFICATION (ID)**.

- 2 If you want to change the sample analysis mode from what is currently selected, press  .
The current analysis mode and range are displayed on the bottom right of the screen.

ID 1007			12 / 07 / 99 16:05
RBC	4.62	WBC	12.3 H
HGB	13.4	NE	64.1
HCT	40.5	LY	27.8
MCV	88	MO	5.6
MCH	29.1	EO	1.8
MCHC	33.1	BA	0.7
RDW	13.		
PLT	280		
ANALYZING			
NEXT ID	1008		CBC/DIFF 1

- 3 If you want to change the Range from what is currently selected, press  until the desired flagging range appears.
- 4 Mix the sample according to your laboratory's protocol.

- 5** Remove the cap from the sample tube according to your laboratory's protocol.



- 6** Present the sample to the probe and press the aspirate switch.
The LEDs flash during sample aspiration.

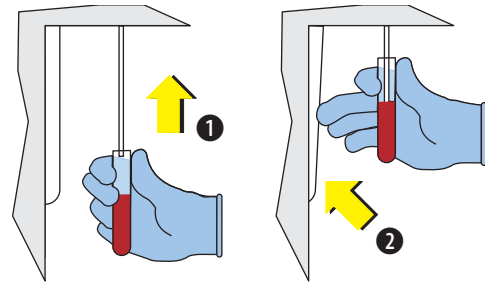

- 7** When the red LED remains illuminated, remove the tube from the probe.
When the green LED remains illuminated, the instrument is ready for the next analysis.

- 8** The sample results appear on the screen and print according to instrument setup.

ID 1007		12 / 07 / 99 16:05	
RBC	4.62	WBC	12.3 H
HGB	13.4	NE	64.1
HCT	40.5	LY	27.8
MCV	88	MO	5.6
MCH	29.1	EO	1.8
MCHC	33.1	BA	0.7
RDW	13.		
PLT	280		
ANALYZING			
NEXT ID	1008		CBC/DIFF 1

- 9 If Autonumbering is on, the instrument is ready to run the next sample.

If Autonumbering is off, enter the next sample ID manually or with the optional barcode reader.

5.3 AFTER ANALYSIS

Results

When analysis is completed, the instrument displays the results and prints the report. Figure 5.1 is an example of a sample report.

If flags appear on the results, see **Chapter 6, REVIEWING RESULTS**.

Figure 5.1 Sample Report

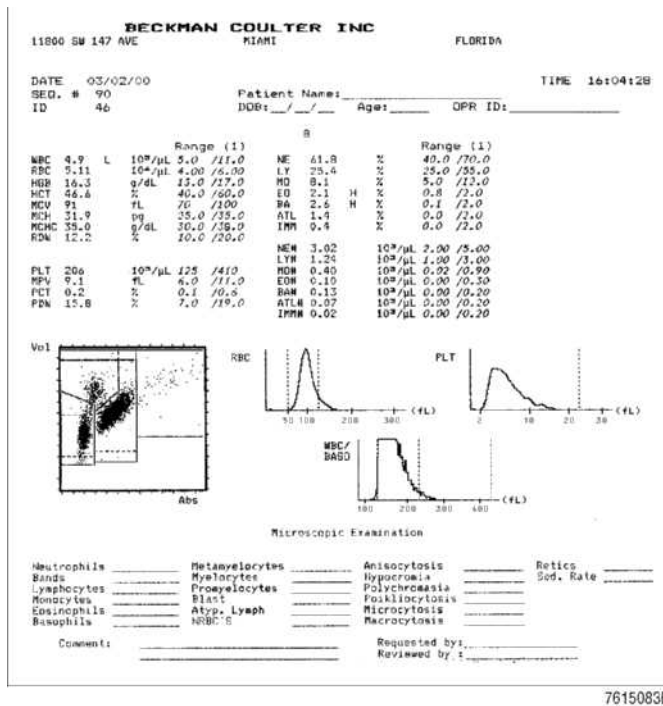

Printing Results for Last Sample Analyzed

There are two ways you can print results for the last sample analyzed:

- If the run screen is displayed, press .
- If the run screen is not displayed, beginning at the Main menu, select **SETUP ► PRINTER ► PRINT LATEST RESULT**.

Auto-Clean

An auto-clean (automatic cleaning) is performed by the instrument after a specified number of samples is analyzed. You can set the frequency from 1 to 75; see **Heading A.19, AUTO-CLEAN FREQUENCY SETTING**.

5.4 SHUTDOWN

At the end of each day, do this procedure to rinse the instrument and place it in a stand-by mode.

1 Press .

The instrument cycles Rinse reagent for cleaning and goes into a stand-by mode.

2 When Shutdown is complete:

- Allow the instrument to remain in stand-by mode,
- OR
- Turn the instrument off.

Note: After doing Shutdown, you must do a **Startup** before operating the instrument again.

5.5 ENTERING THE SAMPLE IDENTIFICATION (ID)

Three methods are available for entering sample IDs on this instrument: auto-numbering, manual, and barcode (optional). For details on selecting the sample ID mode, see **Heading A.14, SELECTING THE SAMPLE IDENTIFICATION (ID) MODE**.

ATTENTION: If the system is set up for a manual ID and no sample ID has been entered, the analysis cycle will not start.

Auto-Numbering

If your instrument is configured to the Autonumbering ID mode, the instrument automatically assigns a sample ID (from 1 to 99999) and increments the number before each analysis.

If you want to override the current autonumber and enter another sample ID, do this procedure.

RUNNING SAMPLES

ENTERING THE SAMPLE IDENTIFICATION (ID)



- 1 Enter the sequence number in the Next ID field.





-
- 2 Press  when the ID is complete.

-
- 3 Do **Running Whole-Blood Samples**.
The ID of the current sample appears in the upper left corner of the screen, and the ID of the next sample appears in the Next ID field.



Manual Sample ID

If your instrument is configured for Manual ID entry, do this procedure to enter a sample identification. You can enter up to 16 alphanumeric characters in the sample ID.

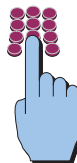

- 1 Press  or  to scroll through the available alpha characters, or enter the number at the numeric keypad.



-
- 2 Move the cursor by pressing  or .

-
- 3** Repeat steps 1 and 2 until you have entered the sample ID.

-
- 4** Press  when the ID is complete.
The ID of the current sample appears in the Analyzing field, and the ID of the next sample appears in the Next ID field.

-
- 5** Do *Running Whole-Blood Samples*.

Scanning the Sample ID with the Barcode Reader

The barcode reader is optional. If your system is equipped with a barcode reader, you can scan the sample ID into the system.

ATTENTION: Beckman Coulter recommends that you verify each barcode reading to ensure correct sample identification.



- 1** Locate the barcode on the sample tube label.

RUNNING SAMPLES

ENTERING THE SAMPLE IDENTIFICATION (ID)

IMPORTANT Risk of sample mis-identification if the entire barcode is not captured with the barcode reader, especially with Interleaved 2-of-5 barcode format. Position the barcode reader over the label to capture the entire barcoded sample ID. Otherwise, part of the sample ID may not be scanned, resulting in mis-identification. Pass the barcode reader over the barcode label on the sample tube.

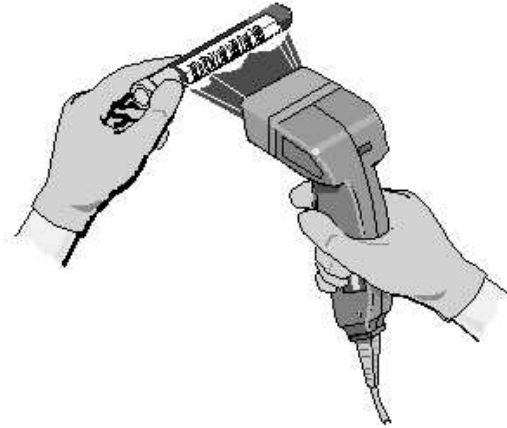

- 2 Pass the barcode reader over the barcode label on the sample tube.

The ID of the current sample appears in the Analyzing field, and the ID of the next sample appears in the Next ID field.

- 3 Verify each barcode reading to ensure correct sample identification.
-

6.1 GENERAL

Patient sample results are generated from sample analysis. There may be instances when a patient sample result is flagged or a parameter number is replaced by a flag.

Carefully review all patient sample results, especially results with flags and/or messages. For details, see **Heading 6.3, FLAGS GENERATED BY THE INSTRUMENT** and **Heading 6.4, INTERPRETIVE MESSAGES**.

IMPORTANT Risk of result inaccuracy if a transient or partial blockage is not detected by the instrument. In rare instances, especially for samples where fibrin or other debris is likely to occur (such as pediatric or oncology samples), a transient or partial blockage may not be detected by the instrument. Therefore, verify flagged results for accuracy and review any result that exceeds your laboratory's limits.

6.2 FLAGS AND INTERPRETIVE MESSAGES

Flags

Definition

A flag is a symbol, set of symbols, or letters generated by the instrument to signal that a certain parameter requires additional attention. Flags can be:

- Linked to a result when it exceeds the normal limits.
- Linked to a problem in the morphology of the blood cell population.
- Linked to instrument operation.

For details, see **Heading 6.3, FLAGS GENERATED BY THE INSTRUMENT**.

Types of Flags

This instrument uses two types of flags – replacement and non-replacement flags.

- Replacement flags, also called codes, replace a parameter's numeric results.
- Non-replacement flags appear next to the parameter results. Up to two of these flags can be displayed for a parameter.

Types of Flag Printout Formats

The system provides two printout formats for reporting the DiffPlot and histogram flags on the patient report – **Suspect** and **Detailed**.

- If the DIFFPLOT AND HISTOGRAM FLAGS print option is **not** selected, samples are flagged using the **Suspect** format. Note: This is the default setting.
- If the DIFFPLOT AND HISTOGRAM FLAGS print option is selected, samples are flagged using the **Detailed** format.

For additional information on print options, see **Configuring the Instrument's Printer Settings**. For additional information on flag printout formats, see **Suspect or Detailed Flag Format**.

Interpretive Messages

Definition

Interpretive messages are triggered from the flagging limits established by your laboratory. These messages indicate possible pathological disorders. For details, see **Heading 6.4, INTERPRETIVE MESSAGES.**

6.3 FLAGS GENERATED BY THE INSTRUMENT

The following sections define these general instrument-generated flags:

- Results Exceeding Instrument Capacity,
- Hemoglobin Errors,
- Voteout Flag,
- WBC Count Flag,
- DiffPlot Flags,
- CBC Flags, and
- Patient Ranges and Action Ranges.

Results Exceeding Instrument Capacity

If a result exceeds instrument capacity, the result will be indicated as follows:

- If the result is below the lower limits of the instrument, the result will be reported as 0. For example, if the WBC is less than $0.1 \times 10^3/\mu\text{L}$, WBC is reported as 0.0.
- If the result is outside the limits at which the parameter can be calculated, the result is replaced by
- If the result is above the instrument's linear range, the result is flagged with +, or if the result is above the instrument's reportable range, the result is replaced by + + + +.

In addition, related parameters may also be flagged or replaced.

Hemoglobin Errors

Hgb Blank Error

The instrument establishes a reference blank reading and compares each sample blank to the reference result. If the blank differs from the reference by more than an allowable amount, the Hgb, MCH, and MCHC results are flagged with a review "R" flag.

If three consecutive samples produce a Hgb blank error, the Hgb, MCH, and MCHC results are replaced by on the third sample.

Hgb Read Error

The instrument reads each sample three times. If the difference among the three readings exceeds a predefined limit, the Hgb, MCH, and MCHC results are flagged with a voteout "V" flag.

Voteout Flag

The instrument performs two counts on the WBC, RBC, Hct, and Plt. If the results for the two counts differ by more than a predefined limit, the WBC, RBC, Hct, and Plt results are flagged with a voteout “V” flag.

- If the WBC result is flagged with a V, then the DIFF number results are also flagged with a V.
- If the RBC result is flagged with a V, then the MCV, MCH, MCHC, and RDW results are replaced by
- If the Hct result is flagged with a V, then the MCV and MCHC results are replaced by
- If the Plt counts votes out, then the Plt result is flagged with a V.

WBC Count Flag

During the data collection for the DiffPlot, the instrument also determines the WBC count from the flowcell.

The WBC flag *DIFF-* or *DIFF+* is reported:

- If the WBC count from the flowcell exceeds the WBC count from the WBC/BASO bath by more than a predefined amount, *DIFF+* is displayed.
- If the WBC count from the flowcell is less than the WBC count from the WBC/BASO bath by more than a predefined amount, *DIFF-* is displayed.
- When a *DIFF-* or a *DIFF+* flag occurs, the WBC count and all DIFF parameters are flagged with an *.

Note: The comparison between the WBC count from the WBC/BASO bath and the WBC count from the flowcell will not be performed when the sample is analyzed in the CBC mode or when this option is disabled in setup.

DiffPlot Flags

When populations in the DiffPlot exceed the limits set for that region, a review (R) flag will occur on the DIFF parameter related to that region.

If the R flag occurs on a DIFF parameter, further investigate the result.

Twelve different flags may occur related to the position of the populations within the DiffPlot:

- | | |
|-------------------------------------|-------------------------------------|
| • <i>Reject</i> | • <i>UM</i> (upper monocyte) |
| • <i>DB</i> (debris) | • <i>LN</i> (lower neutrophil) |
| • <i>SL</i> (small lymphocytes) | • <i>UN</i> (upper neutrophil) |
| • <i>SL1</i> (small lymphocytes 1) | • <i>NE</i> (neutrophil/eosinophil) |
| • <i>NL</i> (neutrophil/lymphocyte) | • <i>ATL</i> (atypical lymphocytes) |
| • <i>MN</i> (monocyte/neutrophil) | • <i>IMM</i> (immature cells) |

See Table 6.1 for additional information.

Table 6.1 Definition of DIFF Flags

DiffPlot Region Flag	DiffPlot Region Affected	Description	Flags	Suspected Abnormalities
		The system detects a problem with volume and absorbance measurements in the flowcell. More than 50% of the pulses were rejected.	R next to all DIFF parameters.	
<i>DB</i>		Occurs when the number of pulses in the DB region exceeds the DB# limit. Default values: 100% or 120 particles.	DB is displayed and printed in WBC flag area.	Plt aggregates Increased Plt count RBCs resistant to lysis (stroma) NRBCs Reagent contamination
<i>SL</i>		Occurs when the number of particles that are counted in the SL region is higher than the SL# limit. Default values: 100% or 50 particles.	R next to: NE%, NE#, LY%, LY#, MO%, MO#, EO%, EO#, ATL%, ATL#, IMM%, IMM#. SL displayed and printed in WBC flag area.	Small lymphocytes Plt aggregates NRBCs RBCs resistant to lysis (stroma)

Table 6.1 Definition of DIFF Flags (Continued)

DiffPlot Region Flag	DiffPlot Region Affected	Description	Flags	Suspected Abnormalities
SL1		<p>Occurs when the number of particles in the SL region is higher than the SL1 number limit and when the percentage of particles in the SL region, relative to the lymphocyte region, exceeds the SL1 percentage limit.</p> <p>Default values: 5% or 45 particles.</p>	<p>May trigger interpretive messages. NRBCs, Plt aggregates, and NRBCs plus Plt aggregates</p> <p>SL1 is displayed and printed in the WBC flag area.</p>	<p>Plt aggregates</p> <p>NRBCs</p> <p>RBCs resistant to lysis (stroma)</p> <p>Small abnormal lymphocytes</p>
NL		<p>Occurs when the number of particles in the NL separation region is above the limits set.</p> <p>Default values: 3% or 120 particles.</p>	<p>R next to: NE%, NE#, LY%, and LY#.</p> <p>NL is displayed and printed in WBC flag area.</p>	<p>Small Neutrophils without granules and/or slight nuclear segmentation</p> <p>Lymphocytes with segment nuclei</p> <p>Neutrophils with weak membranes (smudge/smear cells)</p>
MN		<p>Occurs when the number of particles in the MN separation region is above the limits set.</p> <p>Default values: 100% or 120 particles.</p>	<p>R next to: ATL%, ATL#, IMM%, and IMM#.</p> <p>Replaces NE%, NE#, MO%, and MO# with</p> <p>MN is displayed and printed in WBC flag area.</p>	<p>Monocytes with granules or hyperbasophilic monocytes</p> <p>Immature neutrophils with non-segmented nuclei (band cells)</p>

Table 6.1 Definition of DIFF Flags (Continued)

DiffPlot Region Flag	DiffPlot Region Affected	Description	Flags	Suspected Abnormalities
<i>UM</i>		<p>Occurs when the number of particles in UM region is above the limits set.</p> <p>Default values: 1.1% or 999 particles.</p>	<p>R next to: NE%, NE#, MO%, MO#, IMM%, and IMM#.</p> <p>UM displayed and printed in WBC flag area.</p>	<p>Large monocytes</p> <p>Hyperbasophilic monocytes</p> <p>Myelocytes</p> <p>Promyelocytes</p> <p>Large blasts</p>
<i>LN</i>		<p>Occurs when the number of particles in the LN region is above the limits set.</p> <p>Default values: 2.5% or 999 particles.</p>	<p>R next to all WBC DIFF parameters.</p> <p>LN is displayed and printed in WBC flag area.</p>	<p>Neutrophil degradation due to improper storage or sample age</p> <p>Plt aggregates</p> <p>RBCs resistant to lysis (stroma)</p> <p>Reagent contamination</p>
<i>UN</i>		<p>Occurs when the number of particles in the UN region is above the limits set.</p> <p>Default values: 1.1% or 999 particles.</p>	<p>R next to: NE%, NE#, IMM%, IMM#</p> <p>UN is displayed and printed in WBC flag area.</p>	<p>Large neutrophils</p> <p>Immature granulocytes:</p> <ul style="list-style-type: none"> • Metamyelocytes • Myelocytes • Promyelocytes

Table 6.1 Definition of DIFF Flags (Continued)

DiffPlot Region Flag	DiffPlot Region Affected	Description	Flags	Suspected Abnormalities
NE	 <p>The diagram shows a DiffPlot with Volume on the y-axis and Absorbance on the x-axis. Regions include UM, IMM, UN, Mono, ATL, Lymph, Neut, LN, Debris, and Eos. A shaded region is located in the NE area, which is above the Neut region and to the right of the Lymph region.</p>	<p>Occurs when the number of particles the NE separation region is above the limits set.</p> <p>Default values: 1.1% or 60 particles.</p>	<p>R next to: IMM% and IMM#.</p> <p>Replaces NE%, NE#, EO%, and EO# with </p> <p>NE is displayed and printed in WBC flag area.</p>	<p>Young eosinophils</p> <p>Giant hypersegmented neutrophils</p> <p>Eosinophils with low intracytoplasmic material (agranular eosinophils)</p>
ATL	 <p>The diagram shows a DiffPlot with Volume on the y-axis and Absorbance on the x-axis. Regions include UM, IMM, UN, Mono, ATL, Lymph, Neut, LN, Debris, and Eos. A shaded region is located in the ATL area, which is between the Mono and Lymph regions.</p>	<p>Occurs when a significantly large population is located in the ATL region.</p> <p>ATL flag is triggered from the Patient Limits, and the interpretive message (<i>Atypical Lymphocyte</i>) is triggered from the Action Limits.</p> <p>Default values: 2% or $0.2 \times 10^9/L$.</p>	<p>ATL is displayed and printed in WBC flag area.</p> <p>May be displayed and printed as ATL% and ATL#.</p>	<p>Large lymphocytes</p> <p>Reactive lymphocytes</p> <p>Stimulated lymphocytes</p> <p>Plasma cells</p>
IMM	 <p>The diagram shows a DiffPlot with Volume on the y-axis and Absorbance on the x-axis. Regions include UM, IMM, UN, Mono, ATL, Lymph, Neut, LN, Debris, and Eos. Shaded regions are located in the UN, UM, and Ch127 areas.</p>	<p>Occurs when a significantly large population of cells is located in UN, UM, and channel 127 regions.</p> <p>IMM flag is triggered from the Patient Limits, and the interpretive message (<i>Large Immature Cell</i>) is triggered from the Action Limits.</p> <p>Default values: 2% or $0.2 \times 10^9/L$.</p>	<p>IMM is displayed and printed in WBC flag area.</p> <p>May be displayed and printed as IMM% and IMM#.</p>	<p>Large monocytes</p> <p>Hyperbasophilic monocytes</p> <p>Myelocytes, metamyelocytes, promyelocytes</p> <p>Large blasts</p> <p>Large neutrophils</p>

CBC Flags

There are three types of CBC flags:

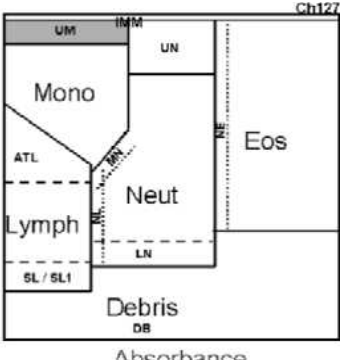
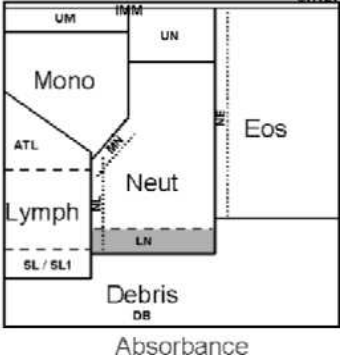
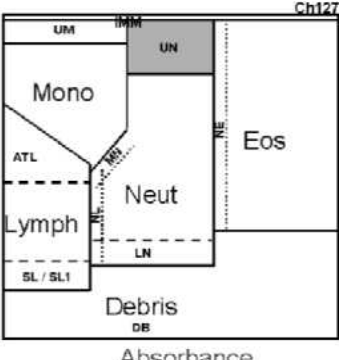
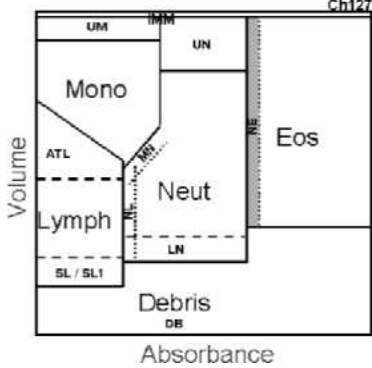
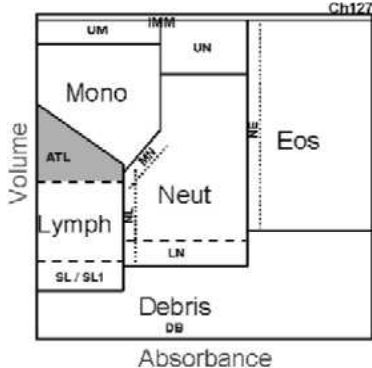
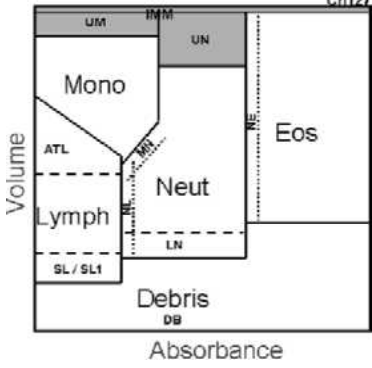
- WBC/BASO histogram flags,
- RBC histogram flags, and
- Plt histogram flags.

See Table 6.2 for additional information.

Table 6.2 CBC Histogram Flags

Histogram	Flag	Illustrations of Histogram Flags	Description
WBC/BASO	*WBC	<p>Figure 6.1 WBC/BASO Histogram Flags: CBC Mode</p> 	<p>Determined from the ratio of the cells counted between the 0 channel and BA1.</p> <p>Indicates the presence of an abnormal number of cells in comparison to leukocytes. Plt aggregates and NRBCs may be found in this region.</p> <p>Default value: 3.5% or 999 particles.</p>
	<p><i>MB</i> (Mono Baso)</p> <hr/> <p><i>BASO+</i></p>	<p>Figure 6.2 WBC/BASO Histogram Flags: CBC/DIFF Mode</p> 	<p>Generated when the percentage of basophils found in the BA channel is above the percentage of the LY/MO/NE raw count found on the DIFF channel.</p> <p>If the BASO% exceeds 50%, a BASO+ flag is generated. The basophils are not taken away from the DiffPlot LY/MO/NE populations.</p> <p>... is displayed and printed instead of the BA% and BA#.</p>

Table 6.2 CBC Histogram Flags (Continued)

Histogram	Flag	Illustrations of Histogram Flags	Description
RBC	MICRO and/or MACRO	<p data-bbox="602 352 1044 415">Figure 6.3 MICRO and MACRO Regions on RBC Histogram</p> 	<p data-bbox="1068 352 1453 604">MICRO and MACRO flags are generated when the percentage of cells counted in the microcytic (MICRO) and macrocytic (MACRO) regions compared to the total number of RBCs are above the established limits set by your laboratory.</p> <p data-bbox="1068 617 1453 772">Thresholds RBC1 and RBC2 define the MICRO and MACRO regions and are calculated based on the standard deviation of a normal RBC population.</p> <p data-bbox="1068 785 1453 848">Default value: 5% for MICRO and 7.5% for MACRO.</p> <p data-bbox="1068 861 1453 951">Note: MICRO and MACRO flags will be activated in software version 1.0 and higher.</p>

Table 6.2 CBC Histogram Flags (Continued)

Histogram	Flag	Illustrations of Histogram Flags	Description
Plt	<i>MIC and SCH</i>	<p>Figure 6.4 Plt Flags</p>  <p>Figure 6.5 Mobile Threshold Positioned in the Standard Regions (Between 18fL and 25fL)</p>  <p>Figure 6.6 Mobile Threshold Cannot Be Positioned in the Standard Region</p>  <p>Figure 6.7 Mobile Threshold Cannot Be Positioned</p> 	<p>The Plt histogram has 256 channels between 2fL and 30fL. A mobile threshold (at 25fL by default) (Figure 6.4) moves according to the presence of microcytic RBCs present in the Plt analysis region. Plt flags generate when the following three conditions occur.</p> <ol style="list-style-type: none"> 1. If the mobile threshold can be positioned in the standard region, between 18fL and 25fL, the MIC (Microcytes) flag will be shown in the Plt alarm region. See Figure 6.5. The Plt result is reliable. 2. If a valley is not detected by the 18fL threshold, the threshold is placed at the 18fL position and a MIC flag is generated. If the interference is significant, the Plt count will also be flagged. 3. If the mobile threshold cannot be positioned between 18fL and 25fL, the threshold is placed at the 18fL position, an SCH (schistocytes) flag is generated, and the Plt count is flagged. Suspected abnormalities include the presence of schistocytes and/or the presence of Plt aggregates. See Figure 6.7 The Plt result is not reliable. Verify the result by an alternative method.

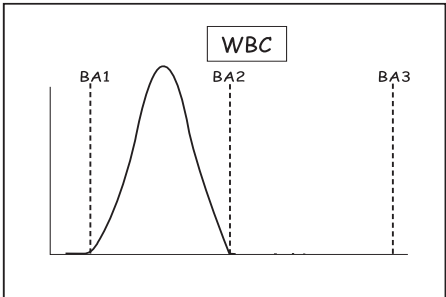
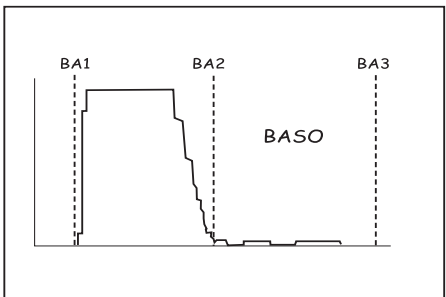
Table 6.2 CBC Histogram Flags (Continued)

Histogram	Flag	Illustrations of Histogram Flags	Description
Plt (continued)	SCL		<p>An SCL (small cell) flag indicates the presence of small cells in the 2fL and 3fL regions.</p> <p>Rerun the sample and verify the results.</p>

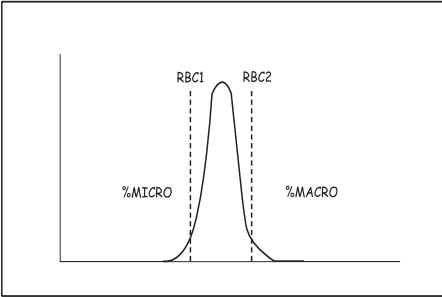
Suspect or Detailed Flag Format

As described in *Types of Flag Printout Formats*, the two types of flag printout formats are **Suspect** and **Detailed** formats.

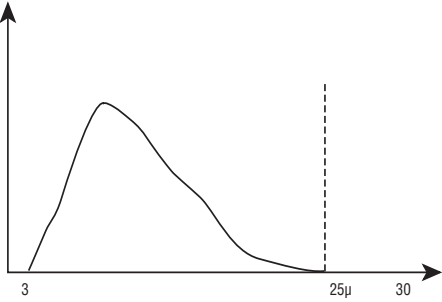
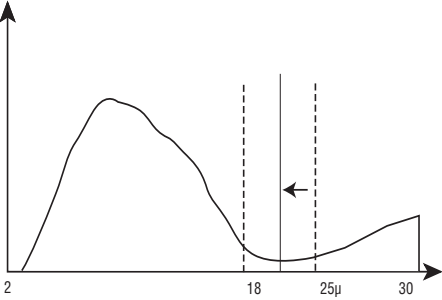
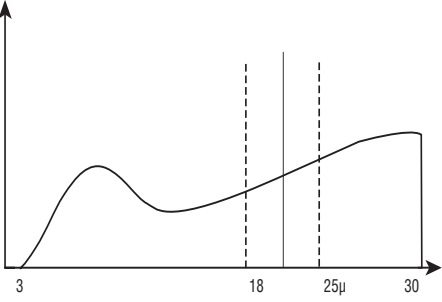
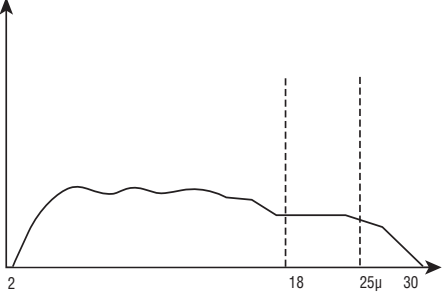
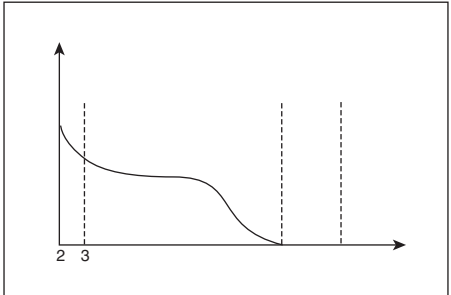
Suspect Flag Format

If the DIFFPLOT AND HISTOGRAM FLAGS option is not selected (default setting) on the instrument's printer configuration screen, the flags are reported (displayed and printed) in the **Suspect** format as follows:

- DB prints as DB.
- The DIFF flag replaces the SL, SL1, NL, MN, UM, LN, UN, and NE flags.
- IMM prints as IMM.
- ATL prints as ATL.
- The WBC/BA flag replaces the DIFF+, DIFF-, *WBC, MB, and BASO+ flags.
- The HISTO flag replaces the MICRO, MACRO, SCL, MIC, and SCH flags.
- The flags will be printed on the patient report in the area labeled "SUSPECT".

For example, when the option is not selected, flags on the patient sample report may be shown as:

SUSPECT:
 WBC: WBC/BA DB DIFF IMM ATL
 RBC: HISTO
 PLT: HISTO

For additional information about the DIFFPLOT AND HISTOGRAM FLAGS print option, see *Configuring the Instrument's Printer Settings*.

Detailed Flag Format

If the DIFFPLOT AND HISTOGRAM FLAGS option is selected on the instrument's printer configuration screen, the DiffPlot and histogram flags are reported (displayed and printed) in the detailed format.

For example, when the option is selected, flags on the patient sample report may be shown as:

```

FLAGS
WBC: *WBC DB SL UM IMM ATL
RBC: MICRO
PLT: MIC
    
```

For additional information about the DIFFPLOT AND HISTOGRAM FLAGS print option, see *Configuring the Instrument's Printer Settings*.

Patient Ranges and Action Ranges

Table 6.3 shows the four flags that can be generated based on patient ranges and action ranges.

Table 6.3 Patient Range and Action Range Flags

Flag	Description
H	Result is above the patient limit set by your laboratory and may generate an interpretive message on the printout.
L	Result is below the patient limit set by your laboratory and may generate an interpretive message on the printout.
HH	Result is above the action limit set by your laboratory and may generate an interpretive message on the printout.
LL	Result is below the action limit set by your laboratory and may generate an interpretive message on the printout.

6.4 INTERPRETIVE MESSAGES

ATTENTION: Interpretive messages indicate a possible pathological disorder and should be used for assisting with quickly and efficiently screening abnormal samples and for diagnosis. It is recommended that your laboratory use suitable reference methods to confirm diagnoses.

The interpretive messages print in the flag area on the patient report. Tables 6.4 through 6.11 list interpretive messages and triggering conditions.

Only one DIFF interpretive message can be displayed for each DIFF parameter. The message generated from the absolute count for that parameter takes priority. For example, if a relative *LYMPHOPENIA* (LY% < LY% LL) and an absolute *LYMPHOCYTOSIS* (LY# > LY# HH) occur, only the *LYMPHOCYTOSIS* message will be displayed.

The following sections define:

- WBC Interpretive Messages,
- RBC Interpretive Messages,
- Plt Interpretive Messages, and
- Combination WBC/RBC/Plt Interpretive Messages.

WBC Interpretive Messages

- Table 6.4 lists WBC interpretive messages from Action Ranges.
- Table 6.5 lists WBC interpretive messages from the DiffPlot.

Table 6.4 WBC Interpretive Messages from Action Ranges

Printed Message	Triggering Condition
LEUCOCYTOSIS	WBC > WBC HH
LEUCOPENIA	WBC < WBC LL
LYMPHOCYTOSIS	LY# > LY# HH, or LY% > LY% HH
LYMPHOPENIA	LY# < LY# LL, or LY% < LY% LL
NEUTROPHILIA	NE# > NE# HH, or NE% > NE% HH
NEUTROPENIA	NE# < NE# LL, or NE% < NE% LL
EOSINOPHILIA	EO# > EO# HH, or EO% > EO% HH
MONOCYTOSIS	MO# > MO# HH, or MO% > MO% HH
BASOPHILIA	BA# > BA# HH, or BA% > BA% HH
LARGE IMMATURE CELLS	IMM# > IMM# HH, or IMM% > IMM% HH
ATYPICAL LYMPHOCYTE	ATL# > ATL# HH, or ATL% > ATL% HH
MYELEMIA	NE% > NE% HH and IMM# > IMM# HH
BLASTS	BA# > BA# HH and IMM# > IMM# HH and UM

*H means above the patient range.
 HH means above the action range.
 LL means below the action range.*

Table 6.5 WBC Interpretive Messages from DiffPlot

Message	Triggering Condition
LEFT SHIFT	MN or NL and UN

RBC Interpretive Messages

- Table 6.6 lists RBC interpretive messages from Action Ranges.
- Table 6.7 lists RBC interpretive messages from Flag Sensitivity.

Table 6.6 RBC Interpretive Messages from Action Ranges

Message	Triggering Condition
ANEMIA	Hgb < Hgb LL
ANISOCYTOSIS	RDW > RDW HH
HYPOCHROMA	MCHC < MCHC LL
COLD AGGLUTININ	MCHC > MCHC HH
MICROCYTOSIS	MCV < MCV LL

Table 6.6 RBC Interpretive Messages from Action Ranges (Continued)

Message	Triggering Condition
<i>MACROCYTOSIS</i>	MCV > MCV HH
<i>ERYTHROCYTOSIS</i>	RBC > RBC HH

*HH means above the action range.
 LL means below the action range.*

Table 6.7 RBC Interpretive Messages from Flag Sensitivity

Message	Triggering Condition
<i>MICROCYTE</i>	MICRO% > MICRO% Flag Sensitivity limit
<i>MACROCYTE</i>	MACRO% > MACRO% Flag Sensitivity limit

Plt Interpretive Messages

- Table 6.8 lists platelet interpretive messages from Action Ranges.
- Table 6.9 lists platelet interpretive messages from the Plt histogram.

Table 6.8 Plt Interpretive Messages from Action Ranges

Message	Triggering Condition
<i>THROMBOCYTOSIS</i>	Plt > Plt HH
<i>THROMBOCYTOPENIA</i>	Plt < Plt LL
<i>MACROPLATELETS</i>	MPV > 11

*HH means above the action range.
 LL means below the action range.*

Table 6.9 Plt Interpretive Messages from the Plt Histogram

MESSAGE	Triggering Condition
<i>MICROCYTOSIS</i>	Derived from Plt histogram
<i>SCHISTOCYTE</i>	Derived from Plt histogram
<i>SMALL CELL</i>	Derived from Plt histogram

Combination WBC/RBC/Plt Interpretive Messages

- Table 6.10 lists interpretive messages from a combination of WBC/RBC/Plt Action Ranges.
- Table 6.11 lists conditions causing *NRBCS* and *PLATELET AGGREGATES* interpretive messages.

Table 6.10 Interpretive Messages from a Combination of WBC/RBC/Plt Action Ranges

Message	Triggering Condition
<i>PANCYTOPENIA</i>	WBC < WBC LL and RBC < RBC LL and Plt < Plt LL

*HH means above the action range.
 LL means below the action range.*

Table 6.11 NRBCs and PLATELET AGGREGATES Interpretive Messages

Message	Triggering Condition
<i>PLT AGGREGATES</i>	Plt < 150x10 ³ /mm ³ and WBC voteout
	DB and PDW > 20, or DB and MPV > 10, or DB and Plt < 150x10 ³ /mm ³ , or DB and WBC Voteout
	*WBC and PDW > 20, or *WBC and MPV > 10, or *WBC and Plt < 150x10 ³ /mm ³
<i>NRBCS</i>	SL, or SL and WBC Voteout, or *WBC and WBC Voteout, or SL1 and WBC Voteout
<i>NRBCS & PLATELET AGGREGATES</i>	If none of the individual conditions defined for <i>NRBCS</i> or <i>PLATELET AGGREGATES</i> occur and *WBC or SL1 or WBC Voteout occur.

REVIEWING RESULTS
INTERPRETIVE MESSAGES

7.1 GENERAL

Calibration is a procedure to standardize the instrument by determining its deviation, if any, from calibration references and to apply any necessary correction factors.

There are two calibration modes available on this instrument:

- Auto-calibration, which uses calibration blood samples.
- Manual calibration, where known calibration factors can be directly entered.

Recommended Calibration Conditions

Beckman Coulter recommends that you do the calibration procedure:

- At ambient operating temperature of 16°C to 34°C (61°F to 93°F).
- Using A^C•T 5diff Cal Calibrator as an alternative to whole blood.

When to Calibrate

Calibrate your instrument:

- During installation, before analyzing samples.
- After service has been performed on the instrument.
- As instructed by a Beckman Coulter representative.

When to Verify Calibration

Verify calibration of your instrument:

- As required by your laboratory procedures, and as required by local or national regulations.
- When cell controls, such as A^C•T 5diff Control, exceed the manufacturer's defined acceptable limits.

In the normal process of tracking data for an extended period of time, your laboratory can decide to recalibrate the instrument for a given parameter. Never adjust to a specific value based on an individual sample result.

7.2 PRE-CALIBRATION CHECKS

Before beginning calibration, it is important that you do these pre-calibration checks.

- 1 Determine if there is enough reagents to complete the entire procedure.
 - If not, do **Replacing Reagents**.
 - If so, go to step 2.

-
- 2** Verify that the instrument has been shut down for at least 30 minutes in the past 24 hours:
- If not, do ***Extended Cleaning Procedure.***
 - If so, go to step 3.

-
- 3** Do ***Startup.***

-
- 4** Do ***Running Cell Controls to Verify Calibration.***
- If the control is within expected ranges, run samples. **Calibration is not necessary if the cell control is within the expected ranges.**
 - If the control is not within expected ranges, do ***Heading 7.3, AUTO-CALIBRATION.*** Calibration is required if the cell control is not within the defined limits.

7.3 AUTO-CALIBRATION

When calibration verification fails, calibrate the instrument using this procedure.

Calibration Setup





1 Select the operator:

- a. Beginning at the Main Menu, select **CALIBRATION** ►► **AUTOCALIBRATION** to access the Autocalibration screen.
- b. Move the cursor to the required operator ID.
- c. Press .

AUTOCALIBRATION		02/27/00 16:05	
7001	<input checked="" type="checkbox"/>	LOT #	CX294
OP2	<input type="checkbox"/>	EXP. DATE	04/05/00
OP3	<input type="checkbox"/>		
OP4	<input type="checkbox"/>		
TARGET VALUES			
WBC	10.4	RBC	4.40
HCT	36.7	PLT	255
		HGB	13.6
<input type="button" value="CONTINUE"/>			

Note: To change an operator ID definition, do *Defining the Operator*.

2 Verify that the lot number is correct:

- If it is correct, go to step 3.
 - If it is not correct, enter the correct lot number.
- a. Move the cursor to the Lot field.
 - b. Press . The cursor should be flashing on the first digit of the lot number to indicate that you can edit the numbers or letters.
 - c. Press  or  to display the letters, and press a number button to enter that number.
 - d. Press  when you are finished editing the lot number.

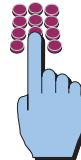

ATTENTION: It is important that you verify the expiration date. The instrument does not generate a flag or alarm if you use an expired material.

- 3** Verify that the expiration date is correct:
- If it is correct, go to step 4.
 - If it is not correct, enter the correct date:
 - a. Move the cursor to the EXP. DATE field.
 - b. Move the cursor under the number you want to replace
 - c. Enter the number.
 - d. Press  when you are finished editing the expiration date.





Note: If you need to change the date format, do **Date Setup**.

4 Verify that the target values are correct:

- If they are correct, move to **CONTINUE**, and press .
- If they are not correct, enter the correct target values:
 - a. Move the cursor to **TARGET**.
 - b. Move the cursor under the number you want to replace.

The cursor should be flashing, which indicates that you can edit the number.

- c. Enter the number.
- d. Press  when you are finished editing the target values.
- e. Repeat steps b through d to edit additional target values, if necessary.
- f. After modifying the target values, move to **CONTINUE** and press . The calibration results chart is displayed.

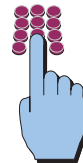

Note: To exit the Auto-calibration screen at any time, press .

Running Calibration

Calibration passes when:

- The CV% is within the limits defined in *Heading A.13, CALIBRATION SETUP*.
- The percentage of difference between the target and the mean value is less than 20.

- 1** Beginning at the Main Menu, press **CALIBRATION >> AUTOCALIBRATION**.

- 2 Move the cursor to **CONTINUE**, and press



The Autocalibration table is displayed.

AUTO-CALIBRATION		02/27/00 16:05			
	WBC	RBC	HGB	HCT	PLT
RUN AT LEAST 3 SAMPLES AND PRESS ENTER TO CALIBRATE					
TARGET	10.4	4.40	13.6	13.7	255
CURR	121	204	42.1	208	268
NEW	---	---	---	---	---
MEAN	---	---	---	---	---
CV%	---	---	---	---	---

- 3 Prepare the calibrator according to the package insert.



- 4 Open the AC•T 5diff Cal Calibrator vial.



- 5 Present the vial to the sampling probe and ensure that the probe is deep inside the vial, press the aspirate switch.

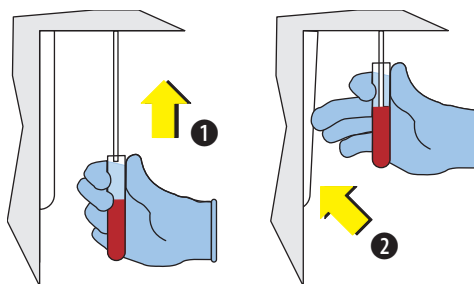

-
- 6** When the red LED remains illuminated, remove the vial and replace the cap on the calibrator.
- When the green LED remains illuminated, the instrument is ready for the next analysis.
-

IMPORTANT Risk of erroneous results if the calibrator is not continuously mixed between each analysis. Continue mixing the calibrator between each analysis.

- 7** Mix the calibrator between each analysis.
-
- 8** When analysis ends, the result is displayed.
-
- 9** Each result used by the instrument for the statistical calculation is selected. If you want to discard a result from the calculation, highlight the result and press  .

ATTENTION: It is recommended that you run the calibrator at least five times to achieve the best calibration.

- 10** Repeat steps 4 through 8 until at least three, but no more than eleven, calibrator samples have been analyzed.

The instrument's autocalibration module performs statistics on these results to obtain the best possible calibration factors.

Note: After three runs, the instrument calculates calibration statistics.

- 11** To accept the calibration factors, press



If calibration passed, *CALIBRATION PASSED* is displayed.

- 12** Update the calibration factors or exit without updating.

- To exit without updating the calibration factors, press
- To update the calibration factors:

- a. Press .
- b. Enter the user password, and press



- c. When calibration is completed, press .

The calibration report is printed. Be sure to keep a copy for your records.

AUTOCALIBRATION		12/07/99 16:05				
	WBC	RBC	HGB	HCT	PLT	
1	9.8	4.46	13.4	38.3	226	
2	9.7	4.43	13.3	38.0	219	
3	9.8	4.42	13.4	37.9	217	
4					222	
5					222	
6					203	
7					228	
TARGET	10.4	4.40	13.6	13.37	255	
CURR	127	197	38.9	207	245	
NEW	126	198	38.5	208	250	
MEAN	10.3	4.41	13.3	38.0	218	
CV%	0.70	0.58	0.34	0.70	3.44	

Interpreting Calibration Results

The calibration table shows:

- *TARGET*: Target values of calibration material.
- *NEW*: Reflects the new calibration factor calculated from the data.
- *CURR*: Reflects the calibration factor currently being calculated.
- *MEAN*: Reflects the mean of the results.
- *CV%*: Reflects the coefficient of variation.

Calibration passes when:

- The CV% is within the limits defined in **Heading A.13, CALIBRATION SETUP**.
- The percentage of difference between the target and the mean value is less than 20.

Forced Calibration

Calibration is forced (required) when:

- The CV% is not within the limits defined in **Heading A.13, CALIBRATION SETUP**.
- The percentage of difference between the target and the mean value is greater than 20.

The out of range CV% is highlighted on the display (Figure 7.1) and a flag (HH or LL) is printed next to the calibration factor.

Figure 7.1 Out of Range Calibration Factors

AUTOCALIBRATION		12/07/99 16:05			
	WBC	RBC	HGB	HCT	PLT
1	9.8	4.46	13.4	38.3	226
2	9.7	4.43	13.3	38.0	219
3	9.8	4.42	13.4	37.9	217
CALIBRATION FAILED PRESS ENTER TO FORCE CALIBRATION ESCAPE TO RETURN					
CURR	127	197	38.9	207	245
NEW	62.2	198	47.0	266	166
MEAN	10.3	4.41	13.3	38.0	218
CV%	0.70	0.58	0.34	0.70	3.44

- 1 Decide if you want to save the new calibration factors or if you want to quit calibration and save the previous factors.
 - If you want to save the new factors, go to step 2.
 - If you want to quit calibration and save the previous factors, press . Do not continue to step 2.

- 2 Press  to force calibration using the new factors.

- 3 Enter the user password, and press .

AUTOCALIBRATION						12/07/99 16:05	
	WBC	RBC	HGB	HCT	PLT		
1	9.8	4.46	13.4	38.3	226		
2	9.7	4.43	13.3	38.0	219		
3	9.8	4.42	13.4	37.9	217		
USER PASSWORD							
TARGET	10.			.1	222		
CURR	127	197	38.9	207	245		
NEW	126	198	38.5	208	250		
MEAN	10.3	4.41	13.3	38.0	218		
CV%	0.70	0.58	0.34	0.70	3.44		

- 4 The calibration report is printed.
Forced Calibration prints on the report as shown in this example.

CALIBRATION		TIME 10:52:17 AM
DATE	12/07/99	
CALIBRATION DATE	02/27/00	
OPERATOR	PAT	
FORCED CALIBRATION		
LOT #	CX292	
EXP. DATE	02/05/01	
TARGET VALUE		10 ³ / uL
WBC	10.2	10 ⁶ / uL
RBC	4.44	g / dL
HGB	13.2	%
HCT	38.1	10 ³ / uL
PLT	222	

- 5 Press  to exit the calibration chart table.

7.4 MANUAL CALIBRATION FACTOR ADJUSTMENT

If you know the calibration factors, you can change them to achieve calibration. Do this procedure if you want to change the calibration factors.

- 1 Beginning at the Main Menu, select **CALIBRATION ► CAL FACTORS**.

- 2 Enter the user password, and press



The Cal Factors screen appears.

CAL FACTORS		02/27/00 16:05
WBC	121	
RCB	204	
HGB	42.1	
HCT	208	
PLT	268	
RDW	0.34	
MPV	1.00	

- 3** Move the cursor to the parameter whose factor you want to change.
-

- 4** Enter the new factors.

Table 7.1 shows the calibration factors ranges for each parameter.

Note: RDW can be calibrated by means of calibration factors. These coefficients are incremented to 0.3 by default. RDW is calculated based on the following formula:





$$\text{RDW result} = \text{RDW coefficient} \times \text{RDWcalculated}$$

- 5** Press .
-

- 6** Repeat steps 3 through 5 as needed.
-

- 7** When you are finished entering new factors, press .

- 8 Save the calibration factors by pressing , or reject the calibration factors by pressing .

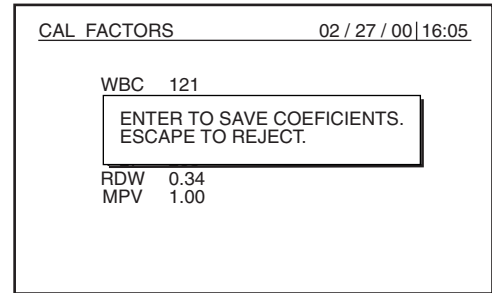

- 9 Perform a quality control check to verify calibration with the AC•T 5diff Control material.

Table 7.1 Calibration Factors Range

Calibration Factor	Minimum	Maximum
WBC	90	200
RBC	160	290
Hgb	25.0	55.0
Hct	160	290
Plt	180	400
RDW	0.1	0.9

7.5 PRINTING CALIBRATION FACTORS

Do this procedure to print the calibration factors.

- 1 Beginning at the Main Menu, select **CALIBRATION >> PRINT CAL FACTORS.**

- 2 Press  to print.
An example of a Calibration report is shown here.

CALIBRATION		
DATE	02/24/00	TIME 10:52:17
CALIBRATION DATE	02/24/00	
OPERATOR	PAT	
LOT #	CX292	
EXP. DATE	03/15/00	
TARGET VALUES		
WBC	10.4	10 ³ / uL
RBC	4.40	10 ⁶ / uL
HGB	13.6	g / dL
HCT	36.7	%
PLT	255	10 ³ / uL
CURR		
WBC	121	
RBC	204	
HGB	42.1	
HCT	208	
PLT	268	
RDW	0.34	
MPV	1.00	

- 3 Keep a copy of the printout for your records.

8.1 GENERAL MAINTENANCE

This chapter details the AC•T 5diff analyzer maintenance procedures that are your responsibility. Also included is a troubleshooting guide to help solve possible instrument problems. Failure to properly execute the maintenance procedures in this chapter may compromise instrument performance.



Perform maintenance procedures either on a time schedule or on an instrument cycle schedule. Mark the maintenance dates on your calendar.

CAUTION Incorrectly performed maintenance procedures can damage the AC•T 5diff analyzer. Do not attempt to do any procedures not included in this manual. Contact a Beckman Coulter representative for service and maintenance beyond the scope of what is documented in this manual.

8.2 MAINTENANCE SCHEDULE

See Table 8.1.

Table 8.1 Maintenance Schedule

Maintenance Procedure	Frequency	Situation
Startup 	Daily	Automatically occurs when you turn on the instrument.
Shutdown 	Daily	Do Heading 5.4, SHUTDOWN to clean the instrument.
Calibration	As needed or when required by your laboratory or regulatory agency	–
Replace reagents	When empty or when there is not enough to complete your daily workload	<i>REAGENT LEVEL LOW</i> message appears on the instrument.
Extended cleaning	As needed	Poor instrument performance.
Replace sampling probe	As needed	–
System Reset Cycle	After an emergency stop of the instrument or when a faulty operation has been detected	–

8.3 CLEANING PROCEDURES

WARNING Risk of biohazardous conditions. Utilize appropriate barrier protection when performing these procedures, as the instrument may contain biohazardous material.

Cleaning the Outside of the Instrument



Clean the outside of the instrument with a damp cloth and distilled water to prevent the buildup of corrosive deposits. Pay particular attention to the sample probe area. Clean up spills promptly.

Cleaning the Inside of the Instrument



If corrosive deposits are evident, clean the inside of the instrument with a damp cloth and distilled water. Be careful not to wipe contaminants into the baths.

Extended Cleaning Procedure

Do this procedure to clean the baths with a 1% to 2% solution of sodium hypochlorite:

- If you suspect a clog or fibrin.
- When directed by a Beckman Coulter representative.

Supplies needed:

- One 5mL syringe
- 50mL of a 1 to 2% chlorine solution produced from high-quality, fragrance-free sodium hypochlorite



- 1 Prepare a 1% to 2% chlorine solution using high-quality, fragrance-free sodium hypochlorite.

For example:



- If using 4% high-quality, fragrance-free sodium hypochlorite, dilute with an equal part of distilled water.
- If using 10% to 12% high-quality, fragrance-free sodium hypochlorite, dilute by adding 10 parts distilled water to 1 part of the 10% to 12% high-quality, fragrance-free sodium hypochlorite.

- 2 Beginning at the Main Menu, select **DIAGNOSTICS ▶ DILUTER SYSTEMS ▶ EXTENDED CLEANING.**

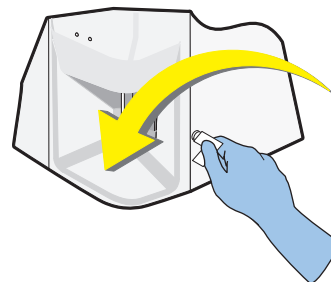

- 3 Open the right door.



- 4 Press  to continue, or press  to exit.



WARNING Risk of contamination. If you do not properly shield yourself while decontaminating the instrument, you may become contaminated. To prevent possible biological contamination, you must use appropriate barrier protections (safety glasses, a lab coat, gloves, and so forth) when performing this procedure.

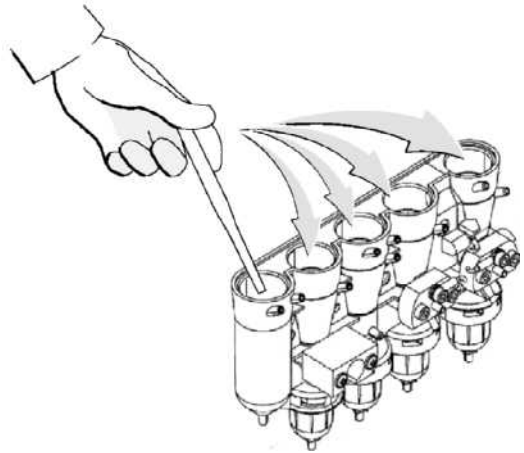

- 5 When the message *POUR 3 mL OF EXTENDED CLEANING REAGENT INTO BATHS* appears, dispense 3 mL of the 1% to 2% chlorine solution into each bath.

- 6 Close the right door.

- 7 Press .
Allow the instrument to complete the cleaning procedure. (Note: It takes about 5 minutes for the cycle to complete.)
The system will automatically flush to remove the chlorine solution that you dispensed in step 5.

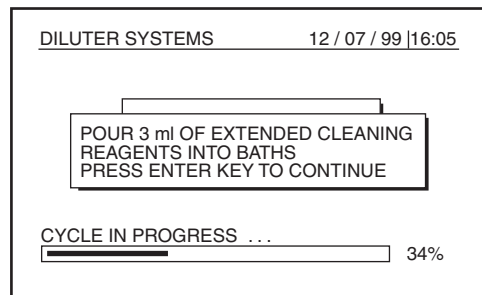

Auto-Clean

An auto-clean (automatic cleaning) is performed by the instrument after a specified number of samples are analyzed. You can set the frequency from 1 to 75; see **Heading A.19, AUTO-CLEAN FREQUENCY SETTING**.

Shutdown

At the end of each day, do Shutdown to rinse the instrument and place it in a stand-by mode.

- 1 Press .

The instrument cycles Rinse reagent for cleaning and goes into a stand-by mode.

- 2 When Shutdown is complete:
 - Allow the instrument to remain in stand-by mode,
OR
 - Turn the instrument off.

Note: After doing Shutdown, you must do a Startup before operating the instrument again.

System Cleaning

Do this procedure to clean the system after analyzing a contaminated sample.

Tools/Supplies Needed:

- 500mL of a 1% to 2% chlorine solution produced from high-quality, fragrance-free sodium hypochlorite
 - Deionized water
 - Absorbent paper
 - Distilled water
 - 2 containers (such as beakers or flasks) that can each hold more than 500mL of liquid and can be placed in front of the reagent compartment when the door is open
-



- 1 Do ***Extended Cleaning Procedure***.

-
- 2** In one container, prepare approximately 500mL of a 1% to 2% chlorine solution using high-quality, fragrance-free sodium hypochlorite.
- For example:
- If using 4% high-quality, fragrance-free sodium hypochlorite, dilute with an equal part of distilled water.
 - If using 10% to 12% high-quality, fragrance-free sodium hypochlorite, dilute by adding 10 parts distilled water to 1 part of the 10% to 12% high-quality, fragrance-free sodium hypochlorite.
-
- 3** Pour 500mL of distilled water into the other container.
-
- 4** Remove all reagent pickup tube assemblies from their containers, including Diluent.
-
- 5** Place all reagent pickup tube assemblies in the chlorine solution.
-
- 6** Beginning at the Main Menu, select **REAGENTS ► PRIME ► ALL REAGENTS**. Chlorine solution will now be pulled into the instrument through the reagent pickup tubes.

7 When priming is complete, remove the reagent pickup tube assemblies from the chlorine solution, and wrap the tubes in absorbent paper.

8 Beginning at the Main Menu, select **REAGENTS ▶ PRIME ▶ ALL REAGENTS**.
The chlorine solution will now be drained from the system.

9 Place the container with the distilled water in front of the reagent compartment.

10 Beginning at the Main Menu, select **REAGENTS ▶ PRIME ▶ ALL REAGENTS**.
The distilled water will now be pulled in to rinse the system.

11 When priming is complete, select **ALL REAGENTS** again to ensure that the distilled water is removed from the system.

12 Press the aspirate switch to run a blank cycle.

13 Re-connect the reagent pickup tube assemblies to their respective containers.

14 Be sure each pickup tube cap is properly tightened.

15 Place the reagent containers in their respective compartments/locations.

16 Beginning at the Main Menu, select **REAGENTS ► PRIME ► ALL REAGENTS**.

17 Inspect the reagent lines to ensure there are no air bubbles present.
If air bubbles are present, repeat step 16.

18 Turn the instrument off and leave it off for about five seconds.

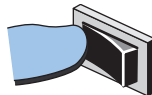

19 Turn the instrument on.

The power on sequence should now perform a startup and background cycle. This sequence also establishes a Hgb blank reference, which is used in a blank check during normal sample analysis.



8.4 SYSTEM RESET CYCLE

The System Reset Cycle performs a general rinse, draining, and initialization of mechanical assemblies.

Do a System Reset Cycle:

- If the instrument halts due to error.
- After an emergency stop of the instrument.
- When the instrument reports a faulty operation.
- When prompted by the instrument.



- 1** Beginning at the Main Menu, select **DIAGNOSTICS** ► **SYSTEM RESET CYCLE**.

-
- 2** The instrument is reset.

8.5 COMPONENT LOCATIONS

See the following figures for component locations:

- Figure 8.1, View of the Pneumatics Area (Right Side),
- Figure 8.2, Bath Assembly,
- Figure 8.3, View Behind Motherboard (Left Side), and
- Figure 8.4, Motherboard.

Figure 8.1 View of the Pneumatics Area (Right Side)

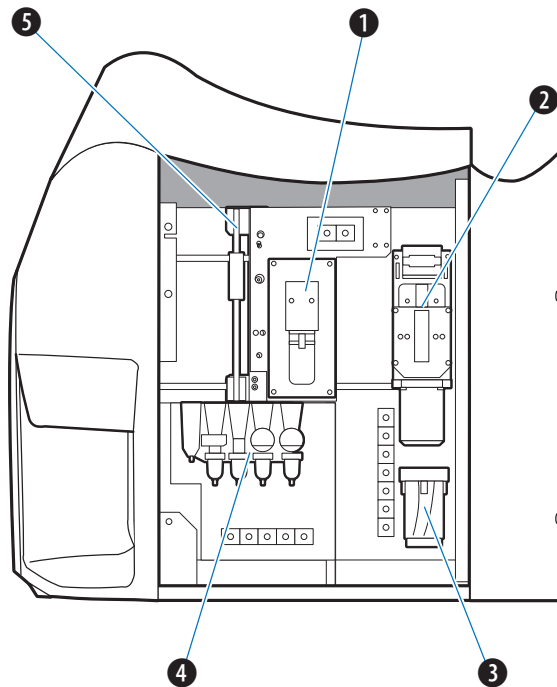

- ➊ Sampling syringe:
 - distributes portions of the specimen into the dilution baths, and
 - takes the sample from the first dilution and distributes it into the RBC bath.
- ➋ Drainage syringe
 - drains the baths,
 - bubbles the mixtures, and
 - transfers, by vacuum, the DIFF specimen from the mixing bath towards to the injector on the optical bench.
- ➌ Diluent tank:
 - holds the necessary diluent for an analysis cycle,
 - prevents diluent degassing as it is being aspirated by the syringes, and
 - is vacuum filled by the counting syringe.
- ➍ Counting assembly:
 - receives the different rinsings and dilutions,
 - regulates the temperature of dilutions, and
 - provides the dilutions for WBC/BASO, RBC/Pit, and Hgb.
- ➎ Sampling traverse:
 - ensures probe positioning for the sample stages and distribution, and
 - supports the sampling syringe.

Figure 8.2 Bath Assembly

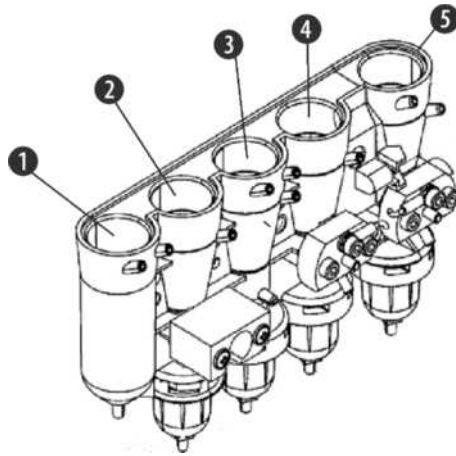

- ① Rinse bath
- ② First Dilution/Hgb bath
- ③ DIFF bath
- ④ RBC bath
- ⑤ WBC/BASO bath

Figure 8.3 View Behind Motherboard (Left Side)

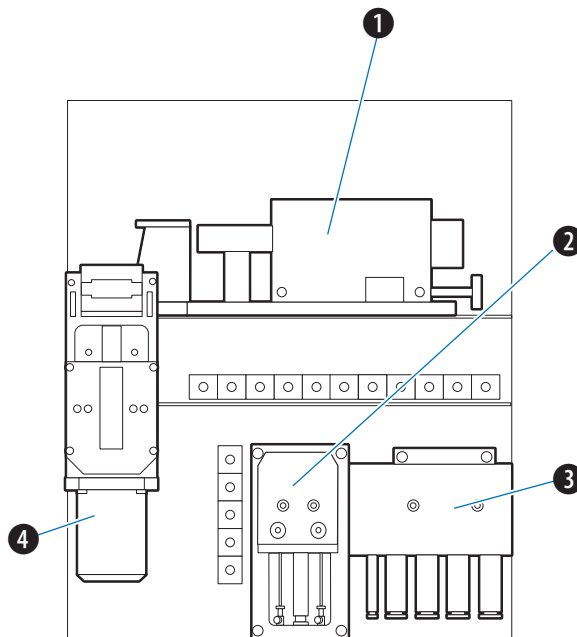

- ① Optical bench: ensures the support and adjustment of the flowcell, lamp, and optical and electronic elements.
- ② DIFF syringe assembly
 - injects the diluted sample into the flowcell, and
 - injects the interior and exterior sheath into the flowcell.
- ③ Reagent syringe assembly
 - ensures correct reagent delivery:
 - ▶ Lysing reagent for Hgb (AC•T 5diff Hgb Lyse)
 - ▶ Rinsing reagent (AC•T 5diff Rinse)
 - ▶ Lysing reagent for DIFF (AC•T 5diff Fix)
 - ▶ Lysing reagent for WBC/BASO (AC•T 5diff WBC Lyse)
 - ▶ Diluent (AC•T 5diff Diluent)
- ④ Counting syringe
 - ensures the vacuum for the WBC and BASO counts,
 - ensures the vacuum for the RBC and Plt counts, and
 - ensures the vacuum for filling the diluent tank with diluent.

Figure 8.4 Motherboard

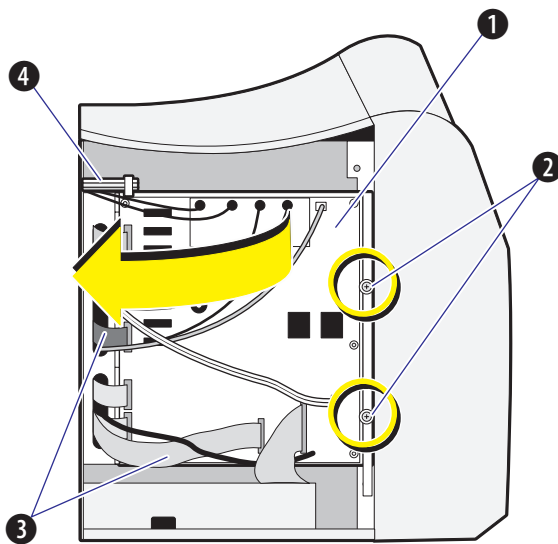

ATTENTION: When opening the Motherboard support panel, use care not to disconnect or damage the electric cables.

- 1 Motherboard:
 - amplifies, processes, and counts the resistive signals and DIFF optical signals, the RBC signal, the Plt signal, and the WBC/BASO signal,
 - measures hemoglobin,
 - pilots the motorized components,
 - manages user interface (control panel buttons, printer, host interface, and barcode reader), and
 - processes data and calculates results.
- 2 Screws that secure the motherboard to the frame.
- 3 Cables that must not be pinched or damaged when the motherboard door is opened.
- 4 Latch that holds Motherboard open.

8.6 SYSTEM TROUBLESHOOTING PROCEDURES

Diluter System

Backflush

The backflush feature pushes pressure through the rear of the apertures to remove blockages.

Do this procedure if you suspect the apertures are blocked.



- 1 Beginning at the Main Menu, select **DIAGNOSTICS** >> **DILUTER SYSTEMS** >> **BACKFLUSH**.

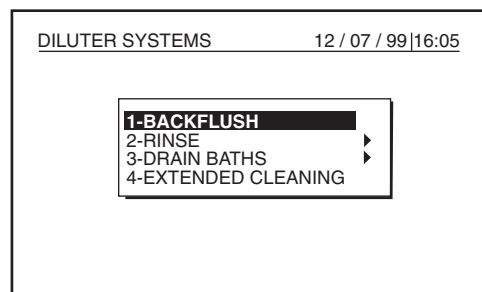

- 2 The instrument performs a backflush.

Bath and Flowcell Rinse

You can rinse the instrument's baths and/or flowcell with A^C•T 5diff Diluent.

- Rinse the baths if you have excessive flagging on CBC parameters.
- Rinse the flowcell to remove bubbles from the flowcell or if you have excessive flagging on DIFF parameters.



- 1 Beginning at the Main Menu, select **DIAGNOSTICS** ▶ **DILUTER SYSTEMS** ▶ **RINSE**.



- 2 Select **BATHS** or **FLOWCELL**.

- 3 The instrument rinses the selected component.

Draining the Baths and/or the Diluent Reservoir

Do this procedure if there is a problem with the baths and/or the diluent reservoir.



- 1** Beginning at the Main menu, select **DIAGNOSTICS** ►► **DILUTER SYSTEMS** ►► **DRAIN BATHS**.
-

- 2** From the Drain Baths menu, select one of the following options:

- **RINSE**
- **FIRST DILUTION**
- **DIFF**
- **WBC/BASO**
- **RBC/PLT**
- **ALL BATHS**
- **DILUENT RESERVOIR**.

Note: If you select **ALL BATHS** or **DILUENT RESERVOIR**, a status bar appears to show progress. For the other options, the red LED illuminates when the function is in progress.

Hardware System

Hardware Reset

Hardware Reset initializes the mechanical assemblies and resets instrument components, such as motors, to a normal or “home” position.



- 1 Beginning at the Main Menu, select **DIAGNOSTICS ▶ HARDWARE SYSTEMS ▶ HARDWARE RESET.**
-

- 2 The instrument resets components to a “home” position.

Checking the Valves

Contact a Beckman Coulter representative for assistance with this procedure.

Checking the Motors

Contact a Beckman Coulter representative for assistance with this procedure.

8.7 REPLACEMENT PROCEDURES

Replacing Reagents

At Startup, the instrument compares the quantity of reagent remaining in each bottle/container to the daily workload settings to determine if there is enough reagents for the day. For additional information, see **Heading A.20, CHANGING THE DAILY WORKLOAD.**

If the instrument determines that the reagent may run out before the end of the daily workload, a **REAGENT LOW LEVEL** message is displayed after Startup. You can either replace the reagent bottle immediately (see **Replacing Fix, WBC Lyse, Hgb Lyse, and Rinse Reagents** or **Replacing the Diluent Reagent**), or you can perform analyses until the specific reagent message [REAGENT LOW LEVEL (XXXXX), where XXXXX represents the reagent name] appears.

Figure 8.5 shows the reagent bottles/containers.

Figure 8.5 Reagent Bottle Location

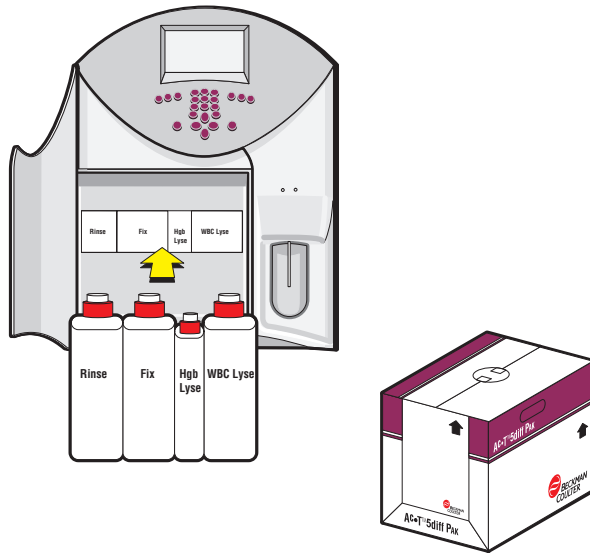

IMPORTANT Risk of instrument error if reagent is poured from one container to another. Never pour reagents from one container to another. Particles at the bottom of the old container can contaminate the new reagent, which will cause unacceptable background results, especially for platelets.

Viewing Reagent Levels

Do this procedure to view a reagent level.



- Beginning at the Main Menu, select **REAGENTS ► LEVEL-CHANGE**.

Note: If a reagent level indicates 0%, you must replace that reagent. Do **Replacing Fix, WBC Lyse, Hgb Lyse, and Rinse Reagents** or **Replacing the Diluent Reagent**.

LEVEL - CHANGE		12 / 07 / 99 16:05
DILUENT	<div style="width: 93%;"><div style="width: 93%;"></div></div> 93%	CHANGE
FIX	<div style="width: 93%;"><div style="width: 93%;"></div></div> 93%	CHANGE
WBC LYSE	<div style="width: 92%;"><div style="width: 92%;"></div></div> 92%	CHANGE
HGB LYSE	<div style="width: 91%;"><div style="width: 91%;"></div></div> 91%	CHANGE
RINSE	<div style="width: 88%;"><div style="width: 88%;"></div></div> 88%	CHANGE
CHANGE ALL		

- Press **ESC** to exit.

Replacing the Diluent Reagent

Replace the Diluent:





- when it is empty, or
- when *REAGENT LOW LEVEL* appears.



- 1 Beginning at the Main Menu, select **REAGENTS ▶ LEVEL-CHANGE**.

Note: If a reagent level indicates 0%, you must replace that reagent.

- 2 Move the cursor to the **CHANGE** bar next to Diluent, and press .

LEVEL - CHANGE		12 / 07 / 99 16:05
DILUENT	 93%	CHANGE
FIX	 93%	CHANGE
WBC LYSE	 92%	CHANGE
HGB LYSE	 91%	CHANGE
RINSE	 88%	CHANGE
		CHANGE ALL

ATTENTION: Do not enter the lot number at this time. If you do, priming will start before the reagent container is replaced.

- 3 The lot number prompt appears for Diluent.
Do not enter the lot number at this time.



- 4** Unscrew the stopper assembly from the container.

- 5** Uncap a new diluent container.

- 6** Put the cap from the new container onto the empty container.

- 7** Properly dispose of the empty container.

- 8** Insert the stopper assembly tube into the new container.

- 9** Tighten the stopper assembly onto the container to ensure an adequate seal.

IMPORTANT Risk of instrument error if the diluent container is further than 80cm (31.5 in.) below the instrument. Be sure the diluent container is no more than 80cm (31.5 in.) below the instrument.

- 10** Put the new container no more than 80 cm (31.5 in.) below the instrument.

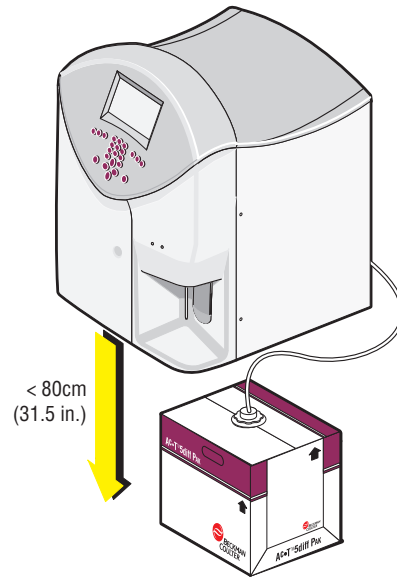

- 11** Enter the lot number from the new reagent container.

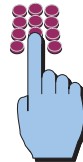

12 Press .

This primes the Diluent and updates the level indicator.

Note: Due to priming, the reagent level may not be displayed as 100%.

ATTENTION: If an instrument error occurs during the prime cycle of a reagent replacement procedure, the reagent is not fully primed and the instrument will not permit sample analysis.

If the error occurs:

1. Press  to acknowledge the error.
2. Run **Heading 8.4, SYSTEM RESET CYCLE.**
3. Manually prime the reagent as instructed in **Priming the Reagents.**

Replacing Fix, WBC Lyse, Hgb Lyse, and Rinse Reagents

Replace a reagent:

- when it is empty, or
- when *REAGENT LOW LEVEL* appears.

Do this procedure to replace Fix, WBC Lyse, Hgb Lyse, or Rinse reagents. To replace Diluent, do **Replacing the Diluent Reagent**.



- 1 Beginning at the Main Menu, select **REAGENTS ► LEVEL-CHANGE**.

Note: If a reagent level indicates 0%, you must replace that reagent.





- 2 Move the cursor to the **CHANGE** bar next to reagent you want to replace, or select

CHANGE ALL, and press .

For example, if you wanted to change the Fix reagent, move the cursor to the Fix **CHANGE** bar and

press .

Note: If you select **CHANGE ALL**, do **Replacing the Diluent Reagent** and the following procedure.

LEVEL - CHANGE		12 / 07 / 99 16:05
DILUENT	 93%	<input type="button" value="CHANGE"/>
FIX	 93%	<input checked="" type="button" value="CHANGE"/>
WBC LYSE	 92%	<input type="button" value="CHANGE"/>
HGB LYSE	 91%	<input type="button" value="CHANGE"/>
RINSE	 88%	<input type="button" value="CHANGE"/>
		<input type="button" value="CHANGE ALL"/>

ATTENTION: Do not enter the lot number at this time. If you do, priming will start before the reagent container is replaced.

- 3** The lot number prompt appears for the selected reagent.

For example, if you are replacing the Fix, this screen would appear.

Do not enter the lot number at this time.

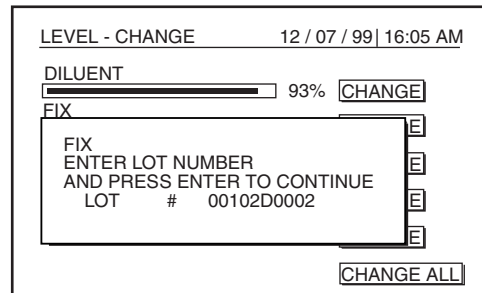

- 4** Open the reagent compartment door.



- 5** Remove the empty bottle from the reagent compartment.

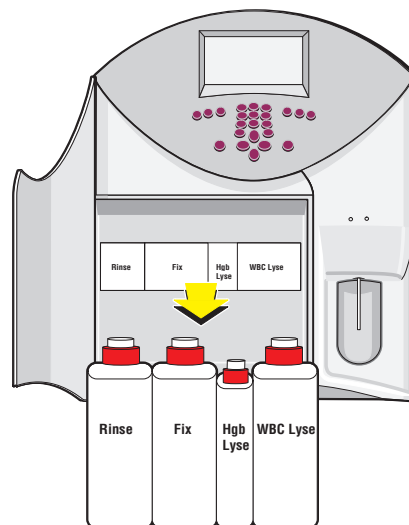

-
- 6** Remove the bottle stopper assembly from the reagent you are replacing.

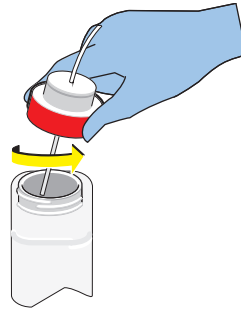

-
- 7** Uncap a new reagent bottle.

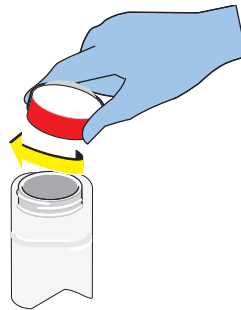

-
- 8** Put the cap from the new container onto the empty container.

-
- 9** Properly dispose of the empty bottle.

-
- 10** Insert the stopper assembly tube into the new bottle.



-
- 11** Tighten the stopper assembly onto the bottle to ensure an adequate seal.

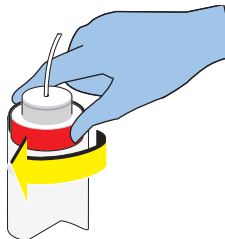

-
- 12** Put the new reagent bottle in the reagent compartment.
A^C•T 5diff Rinse is shown here.

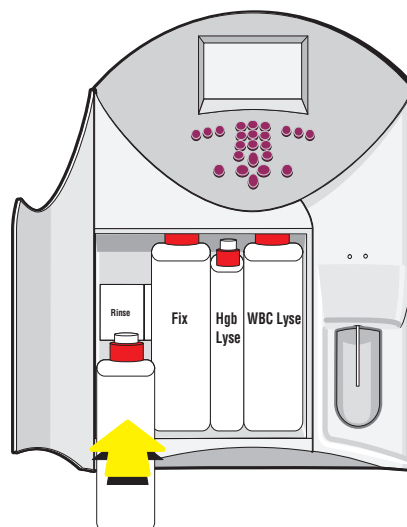

-
- 13** Close the reagent compartment door.

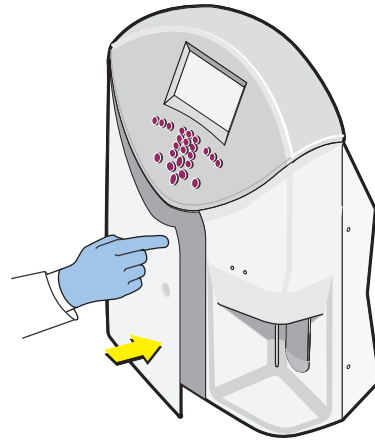

-
- 14** Enter the lot number from the new reagent container.

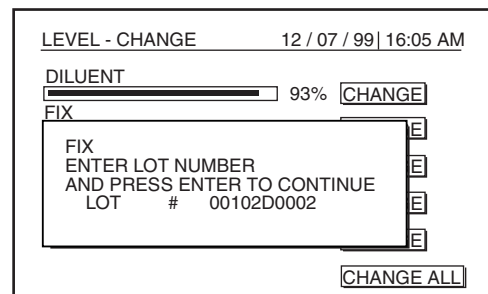

15 Press .

This primes the reagent you replaced and updates the level indicator.

Note: Due to priming, the reagent level may not be displayed as 100%.

ATTENTION: If an instrument error occurs during the prime cycle of a reagent replacement procedure, the reagent is not fully primed and the instrument will not permit sample analysis.

If the error occurs:

1. Press  to acknowledge the error.
2. Run **Heading 8.4, SYSTEM RESET CYCLE**.
3. Manually prime the reagent as instructed in **Priming the Reagents**.

Priming the Reagents

The function primes reagents into the instrument.

Do this procedure after service has been performed on the instrument.

ATTENTION: This function does not reset the reagent cycle. Do not do this procedure to change reagents.

- 1** Beginning at the Main Menu, select **REAGENTS ► PRIME**.
-

IMPORTANT Risk of unacceptable background results. Initiating two Hgb Lyse or WBC Lyse prime cycles back-to-back causes excessive foaming in the waste chamber, which may produce interference that might cause unacceptable background results. Run a blank cycle before repeating a Hgb Lyse or WBC Lyse prime cycle.

- 2** Select the desired option.

- 3 The instrument primes the selected reagent(s).

Replacing the Waste Container

WARNING Risk of biohazardous condition if the waste sensor alarm battery is not promptly replaced when needed. The waste sensor alarm uses a 9-V alkaline battery for operation. The waste sensor unit will alert you that the battery needs to be replaced. If the waste container is not full and the alarm “chirps” (beeps) at regular intervals, **immediately** replace the old battery with a new 9-V alkaline battery to ensure correct operation of the waste sensor alarm.

There is a waste sensor alarm unit mounted on back of the instrument (Figure 8.6).

Figure 8.6 Waste Sensor Alarm Unit Location

As the waste container fills, there is a float on the sensor that triggers the alarm, which then emits a continuous, intermittent beep until the waste container cap is removed.

If you need to move the waste sensor alarm closer to the waste container, gently pull the alarm unit from the back of the instrument.

Do this procedure when the waste sensor alarm sounds or as needed.

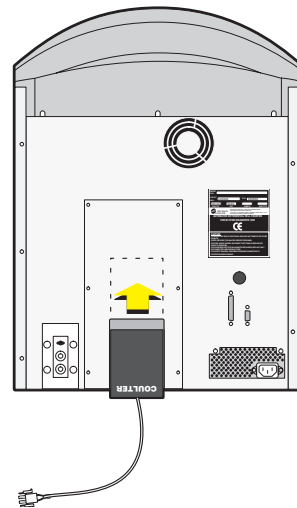

- 1 Carefully remove the cap (with waste sensor attached) from the waste container.

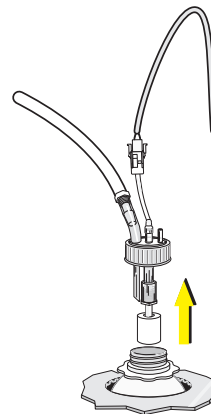

-
- 2** Replace the waste container according to your laboratory's guidelines.

-
- 3** Insert the waste sensor float into the new waste container and properly secure the cap.

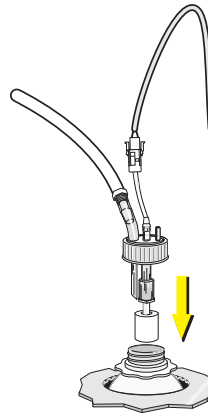

WARNING Risk of personal injury if waste is not neutralized before the waste container is capped. Non-neutralized waste contents may produce gas, which can build up pressure in a capped container. Neutralize waste contents after removing the waste container and before capping it for disposal.

-
- 4** Do *Neutralizing the Waste and Treating for Biohazards*.

Replacing the Flowcell Lamp

Do this procedure:

- when the flowcell lamp fails, or
- when instructed by a Beckman Coulter representative.

Tools/Supplies needed:

- Hex keys, 2 mm and 3 mm
- Flowcell lamp

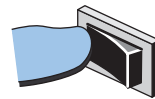

- 1** Turn the instrument off.

-
- 2** Unplug the instrument from its power source.

3 Remove the side and top covers of the instrument:

- a. Remove the four hex screws securing the left door to the instrument frame. Set screws aside for use later.
- b. In the left compartment, remove the hex screw from the upper front corner.
- c. Open the right door and remove the hex screw in the upper front corners.

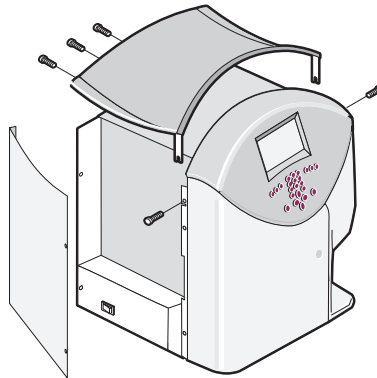
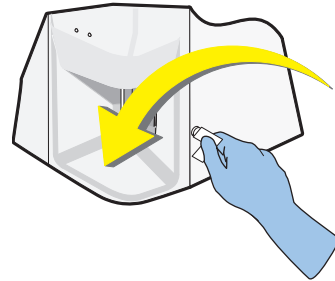
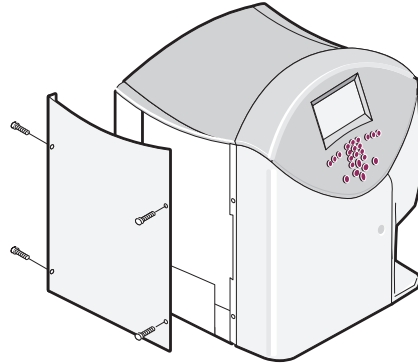

- d. At the rear of the instrument, remove the three hex screws that secure the top cover to the instrument frame.
- e. Carefully remove the top cover and set it aside.

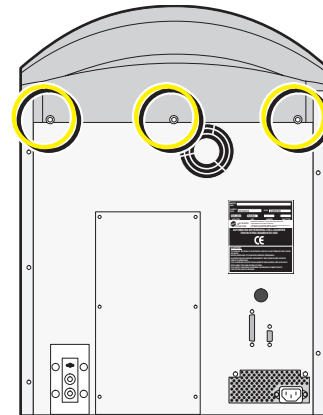

WARNING Risk of personal injury due to hot surfaces within the instrument. Use care when working in this area. Some of the surfaces may be very hot and can burn you.

- 4 Disconnect the lamp from the Power Supply:
 - a. Locate the lamp and the connector on the left side of the optical bench.
 - b. Disconnect the lamp from the Power Supply.
 - c. Note how the existing lamp is seated:
 - The metal bracket holding the lamp is keyed to ensure proper positioning.
 - There are two different notches: – one is a semi-circle that matches a circular raised area, and the other is a square notch that matches a raised square.

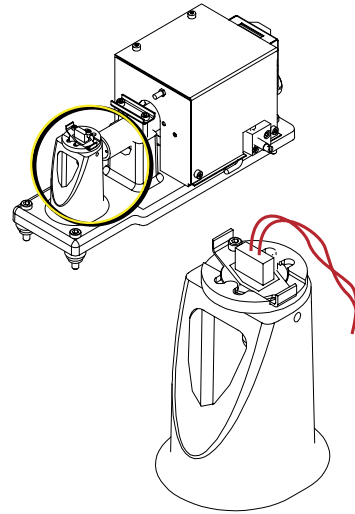

- 5 Remove the lamp:
 - a. Use a 2 mm hex key to loosen the two screws a few turns.
 - b. Separate the metal bracket from the lamp and cable assembly.
 - c. Save the metal bracket and screws.
 - d. Turn the lamp counterclockwise to remove it from its housing.

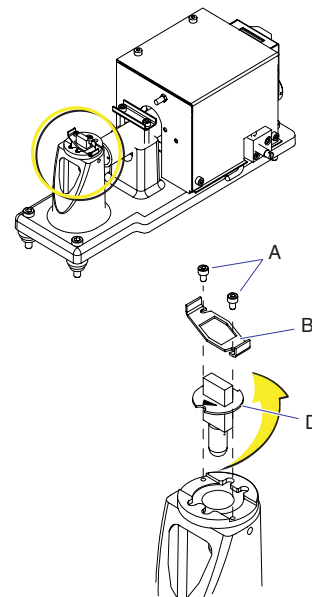

-
- 6** Discard the old lamp assembly.
-

IMPORTANT Risk of compromising output of the new lamp if the surface is smudged. Fingerprints or other smudges on the lamp can affect output. Do not touch the surface of the lamp.

- 7** Using care not to touch the surface of the lamp:
- Insert the new lamp assembly inside the housing.
 - Place the bracket (with wings up) on the housing.
 - Turn the lamp assembly clockwise until secure.
 - Reinstall the two screws removed in step 5.
 - Reconnect the lamp to the Power Supply.

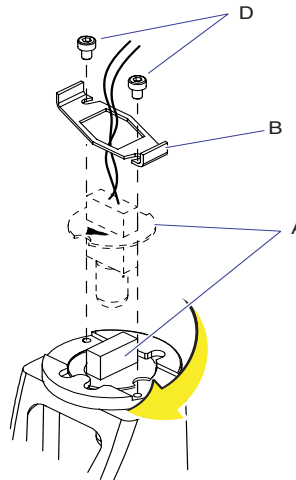

-
- 8** Plug the instrument's power cord into the electrical outlet.
-

- 9** Verify correct operation:
- Turn the instrument on.
 - While the instrument is performing a startup and background check, look to see that the new lamp is lighted.
 - If it is, go to step 10.
 - If it is not, then troubleshoot the system to determine the problem.



- 10** When the startup routine is done, turn the instrument off and unplug it from the power outlet.

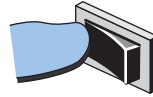

- 11** Replace the top cover.
- Place the top cover on the instrument.
 - Fasten the three hex screws to secure the cover to the instrument frame.

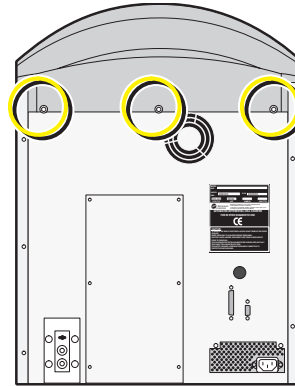

- Replace the left door, and fasten the four hex screws to secure the door to the instrument frame.
- Close the right door.

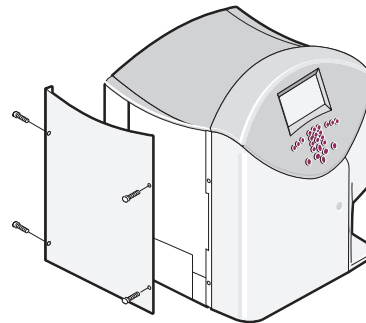

- 12** After closing all doors and replacing all covers, plug the instrument into the power source.

- 13** Turn the instrument on, and verify instrument performance by running a fresh, whole-blood sample.



8.8 SYSTEM ERRORS

What Error Messages Mean

Table 8.2 lists errors messages that may appear on the instrument.

Table 8.2 Error Messages

Message	Probable Cause	Suggested Action
<i>AT LEAST 3 TAGGED RESULTS REQUIRED</i>	At least 3 results are required for calibration calculations and less than 3 have been run.	Run at least three results for calculation results to be generated.
<i>BATH ENCLOSURE DOOR OPENED</i>	If a cycle is attempted while the right side door is open, this message is generated.	1. Close the door. 2. Do Heading 8.4, SYSTEM RESET CYCLE .
<i>DATA NOT SAVED, VALUE OUT OF RANGE</i>	The value typed in is not an acceptable value. It may be out of an expected range or an incorrect data type.	Re-enter the data.
<i>DRAIN TIMEOUT</i>	Problems with draining.	1. Do Heading 8.4, SYSTEM RESET CYCLE . 2. If the problem persists, contact a Beckman Coulter representative.
<i>ENTER AN IDENTIFICATION</i>	An ID is required to run an analysis in the Manual ID mode.	Enter the sample ID.
<i>INCORRECT DATE ENTRY</i>	Value entered is not a valid date.	Enter a valid date.
<i>INCORRECT TIME ENTRY</i>	Time entered is not a valid time.	Enter a valid time.
<i>NO ACK CHARACTER RECEIVED ON RS232</i>	There is a problem with the communication or handshaking to the host computer.	Verify that the protocol set up in the host transmission screen matches the protocol expected by the host computer.
<i>NO DILUENT, CHECK LEVEL</i>	Diluent reservoir is unable to fill.	Check the diluent level. If necessary, do Replacing the Diluent Reagent .
<i>NO ENQ CHARACTER RECEIVED ON RS232</i>	There is a problem with the communication or handshaking to the host computer.	Verify that the protocol set up in the host transmission screen matches the protocol expected by the host computer.
<i>PRINTER ERROR, CHECK PAPER</i>	An error indication has been sent from the Printer to the instrument; usually a paper out message.	1. Ensure there is paper in the Printer. 2. Refer to the Printer user's manual for additional information.
<i>REAGENT LOW LEVEL [REAGENT NAME]</i>	The calculated reagent level for the specified reagent indicates no reagent.	Check the reagent level. If necessary, do Replacing the Diluent Reagent and/or Replacing Fix, WBC Lyse, Hgb Lyse, and Rinse Reagents .
<i>REAGENTS LOW LEVEL</i>	This message is given at the end of startup if there is not enough reagent left to complete the daily workload that has been set up.	Monitor the reagent levels, If necessary, do Replacing the Diluent Reagent and/or Replacing Fix, WBC Lyse, Hgb Lyse, and Rinse Reagents .

Table 8.2 Error Messages (Continued)

Message	Probable Cause	Suggested Action
<i>SYSTEM ERROR, RUN SYSTEM RESET CYCLE</i>	<p>During a cycle, a system error of the following type has caused the system to stop:</p> <ul style="list-style-type: none"> • A motor has not returned to its home sensor when expected. • A drain problem has been detected at one of the two drain sensors. • The right side door has been opened during a cycle, losing temperature control at the baths. • A mechanical problem. 	<ol style="list-style-type: none"> 1. Do Heading 8.4, SYSTEM RESET CYCLE. 2. If the problem persists, note the error message and contact a Beckman Coulter representative.
<i>TEMPERATURE OUT OF RANGE</i>	<p>The temperature in the counting bath compartment is outside of the acceptable range.</p>	<ol style="list-style-type: none"> 1. Ensure the sure right side door is closed. 2. Wait a few minutes. 3. If the problem persists, contact a Beckman Coulter representative.
<i>THE PRINTER IS DISCONNECTED, SWITCHED OFF, OR HAS NOT BEEN SELECTED</i>	<p>No or incorrect communication between Printer and instrument</p>	<ol style="list-style-type: none"> 1. Ensure the cable is properly connected. 2. Ensure the Printer is turned on. 3. Ensure the Printer is online or selected.
<i>TIMEOUT OVERFLOW ON RS232</i>	<p>There is a problem with the communication or handshaking to the host computer.</p>	<p>Verify that the protocol set up in the host transmission screen matches the protocol expected by the host computer.</p>
<i>USER PASSWORD</i>	<p>A password is required to perform the requested action.</p>	<p>Enter the user password.</p>
<i>WRITE ERROR RS232</i>	<p>There is a problem with the communication or handshaking to the host computer.</p>	<p>Verify that the protocol set up in the host transmission screen matches the protocol expected by the host computer.</p>
<p><i>XXX NOT REACHING HOME</i> Note: XXX = name of motor.</p>	<p>Motor did not reach home sensor.</p>	<ol style="list-style-type: none"> 1. Do Hardware Reset. 2. Do Heading 8.4, SYSTEM RESET CYCLE. 3. If the problem persists, contact a Beckman Coulter representative.

8.9 TROUBLESHOOTING GUIDES

Troubleshoot instrument problems by using Table 8.3. For additional information, see *Appendix D, TROUBLESHOOTING FLOWCHART*.

Table 8.3 Troubleshooting Guide

Problem Area	Situation	Probable Cause	Suggested Action
Power	Power will not turn on	Power cord loose or not securely connected.	Ensure that the power cord is properly connected.
		Instrument is turned off.	Turn the instrument on.
		No voltage or wrong voltage at laboratory power outlet.	Ensure the voltage is on and that the outlet is the correct Vac.
		Defective power switch or blown fuse.	Contact a Beckman Coulter representative.
Startup	Startup failed three times	–	<ol style="list-style-type: none"> 1. Verify the reagents are not expired. Replace reagent if necessary. See Replacing Reagents. 2. Do Startup again. 3. Do Extended Cleaning Procedure.
	Temperature not reached	Instrument did not reach operating temperature.	Wait 5 minutes to allow the instrument to reach the operating temperature. If the problem persists, contact a Beckman Coulter representative.
	Control verification out of acceptable limits	–	<ol style="list-style-type: none"> 1. Do Extended Cleaning Procedure. 2. Rerun the control. 3. Run a new vial of control. 4. Calibrate the instrument.
Sampling	Sample probe not working properly.	Motor	Contact a Beckman Coulter representative.
Dilution	Traverse motion	Motor problem	<ol style="list-style-type: none"> 1. Ensure there is enough reagent in each bath. 2. If the problem persists, contact a Beckman Coulter representative.
	Sample distribution	Pneumatic/syringe problem	Analyze a sample and check that specimen is correctly distributed into the baths. See Aspiration .
	Drain and rinse	Pneumatic/syringe problem	<ol style="list-style-type: none"> 1. Drain the baths. See Draining the Baths and/or the Diluent Reservoir. 2. Rinse the baths. See Bath and Flowcell Rinse. 3. If the problem persists, contact a Beckman Coulter representative.

Table 8.3 Troubleshooting Guide (Continued)

Problem Area	Situation	Probable Cause	Suggested Action
Results	Poor reproducibility	Bent sample probe	Contact a Beckman Coulter representative.
	Poor precision	Bent sample probe	Contact a Beckman Coulter representative.
	Stable RBCs and unstable Plts	Bent sample probe	Contact a Beckman Coulter representative.
Printer	Printer does not work	Printer may be turned off.	Turn the printer on.
		Printer may not be setup or connected properly	Refer to the printer user's manual.
	Printer does not print results correctly	Printer may not be in Draft Mode.	Put the printer in Draft Mode.
Reagents	–	Not enough reagent in the bottle/container.	Do Replacing Reagents .
	Waste sensor alarm beeps	Waste container is full.	Do Replacing the Waste Container .
Incorrect mechanical operation	Defective stepper motors	Motor alarms are triggered. Current cycle stops.	Do Hardware Reset .
Incorrect pneumatic operation	Leaks or blockages	Reagent alarms are triggered. Current cycle stops.	1. Do Heading 8.4, SYSTEM RESET CYCLE . 2. Do Bath and Flowcell Rinse . 3. Do Priming the Reagents .
Incorrect optical operation	Defective optical parts. Dirty optical parts.	Specific flags. Hgb blank cycle measurements are outside acceptable limit.	1. Do Heading 8.4, SYSTEM RESET CYCLE . 2. Do Bath and Flowcell Rinse . 3. Do Priming the Reagents .
Incorrect electrical operation	Incorrect main supply voltage	Instrument would not initialize.	Ensure correct voltage from power source.

– means not applicable.

A.1 INSTALLATION

A Beckman Coulter Service Representative will install your instrument and printer.

A.2 DEFAULT CONFIGURATION

Your instrument was configured prior to installation. Table A.1 shows the default configuration information.

Table A.1 Instrument Default Settings

Feature	Default Settings	To Change the Setting
Date format	MM/DD/YY	Do <i>Selecting the Date Format</i> .
Time format	AM/PM	Do <i>Selecting the Time Format</i> .
Reporting unit	US	Do <i>Heading A.7, REPORTING UNIT SELECTION</i> .
Language	ENGLISH	Do <i>Heading A.4, LANGUAGE AND USA FIELD SELECTION</i> .
Sample ID mode	AUTONUMBERING	Do <i>Heading A.14, SELECTING THE SAMPLE IDENTIFICATION (ID) MODE</i> .
Barcode with checksum	YES	Do <i>Heading A.18, SELECTING BARCODE WITH CHECKSUM</i> .
Display DIFF #	NO	Do <i>Heading A.15, DISPLAYING DIFF # OR DIFF %</i> .
Enable ATL, IMM, PCT, and PDW	NO	Do <i>Heading A.16, ENABLING ATL, IMM, PCT, AND PDW</i> .
Operator	OP1, OP2, OP3, and OP4	Do <i>Defining the Operator</i> .
Daily workload	CBC runs per day: 10 CBC/DIFF runs per day: 10	Do <i>Heading A.20, CHANGING THE DAILY WORKLOAD</i> .
Autoclean frequency	75	Do <i>Heading A.19, AUTO-CLEAN FREQUENCY SETTING</i> .
Printer configuration	Paper length (in.): 11 Patient range printout: YES Messages printout: YES DiffPlot & Histogram Flags: NO Histogram Thresholds: NO Print raw values: NO Zoomed print screen: NO Disable printer: NO Print format: OPTION 1	Do <i>Heading A.10, PRINTER CONFIGURATION</i> .
Patient ranges (1)	CBC. See Table A.3. DIFF. See Table A.4.	Do <i>Changing CBC Patient Ranges</i> . Do <i>Changing DIFF Patient Ranges</i> .
Action ranges (1)	CBC. See Table A.5. DIFF. See Table A.6.	Do <i>Changing CBC Action Ranges</i> . Do <i>Changing DIFF Action Ranges</i> .

A.3 CHANGES TO INSTRUMENT SETUP

Any time you change the instrument setup, print a setup report for your records. See **Heading A.12, PRINTING A SYSTEM SETUP REPORT.**

A.4 LANGUAGE AND USA FIELD SELECTION

Do this procedure to select the language in which you want the instrument's software to be displayed and/or to select the USA field.

ATTENTION: The USA field must be selected on all instruments installed in the United States. In conjunction with the selection of Pct, PDW, ATL, and IMM parameters, the USA field controls the activation of the message "In USA, Pct, PDW, ATL, and IMM are for Research Use Only."

-
- 1 Beginning at the Main menu, select **SETUP ▶ OTHERS ▶ LANGUAGE.**

-
- 2 Move the cursor to the desired option.

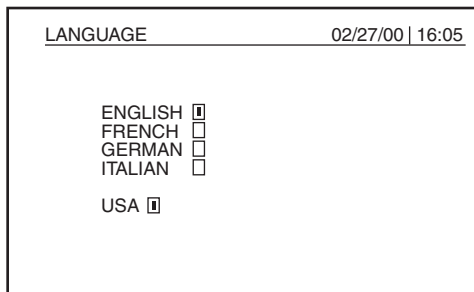

A screenshot of a terminal-style menu titled "LANGUAGE" with a timestamp "02/27/00 | 16:05" in the top right corner. The menu lists five options, each with a small square cursor icon to its right: ENGLISH, FRENCH, GERMAN, ITALIAN, and USA. The USA option is currently selected, indicated by a small square cursor icon to its right.

-
- 3 Press  to select the language.

-
- 4 Press  to return to the previous menu.

A.5 PASSWORD SETUP

A user password is required to:

- Change calibration factors,
- Configure RS 232 (host transmission),
- Change the user password,
- Change calibration CV% limits, and
- Force calibration.

Do this procedure to change the password. (The default user password is 123.)

1 Beginning at the Main menu, select **SETUP ▶ OTHERS ▶ CHANGE PASSWORD**.

2 Enter the current user password, and press . The current password is displayed.

3 Enter the new user password (up to four characters).

Note: If you make a mistake, press .

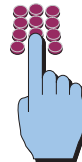

4 Press  to save the changes.

5 Press  to return to the previous screen.

A.6 DATE/TIME SETUP

You can set the current date and time according to your laboratory's requirements.

Date Setup

There are three date formats from which you can choose:

- DD/MM/YY (Format example: 11/01/00 for January 11, 2000.)
- MM/DD/YY (Format example: 01/11/00 for January 11, 2000.)
- YY/MM/DD (Format example: 00/01/11 for January 11, 2000.)

Note: DD represents the day of the month, such as 11 for the 11th. MM represents the month, such as 02 for February. YY represents year, such as 99 for 1999 or 00 for 2000.

Selecting the Date Format

Do this procedure to select a date format.

-
- 1 Beginning at the Main Menu, select **SETUP ► DATE/TIME ► DATE FORMAT**.

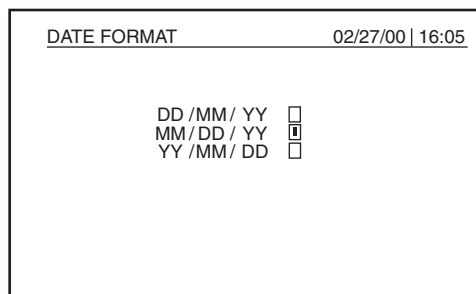

-
- 2 Move the cursor to the desired format.

-
- 3 Press .

-
- 4 Press  to save and exit.

Selecting the Time Format

Do this procedure to select a time format.

- 1 Beginning at the Main Menu, select **SETUP** ►► **DATE/TIME** ►► **TIME FORMAT**.

- 2 Select the desired time format.

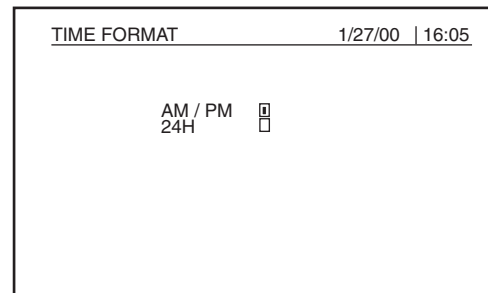



- 3 Press  to save and exit.

Setting a New Date and Time

Do this procedure to enter a new date and time into the instrument.

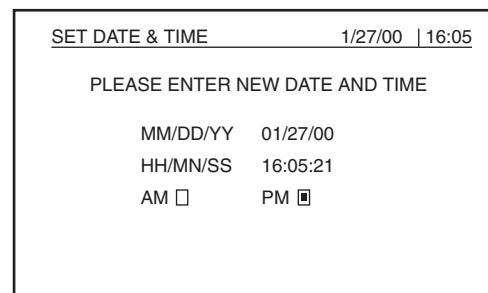
- 1 Beginning at the Main Menu, select **SETUP** ►► **DATE/TIME** ►► **SET DATE & TIME**.



-
- 2** Enter the correct date, and press .
The cursor moves to the time field.



-
- 3** Enter the correct time, and press .
The cursor moves to the AM/PM field, unless you are using the 24-hour time format. If you are using the 24-hour time format, go to step 5.



-
- 4** If you are using the AM/PM time format, select **AM** or **PM** for the current time:
- Move the cursor to the desired option.
 - Press .

-
- 5** Press  to save and exit.

A.7 REPORTING UNIT SELECTION

By selecting a reporting unit, you are selecting the format in which numeric results are reported. You can choose from these reporting units:

- US
- SI 1
- SI 2
- SI 3
- SI 4

Table A.2 shows the reporting unit formats for each parameter.

Table A.2 Reporting Unit Format

Parameter	Reporting Unit				
	US	SI 1	SI 2	SI 3	SI 4
WBC	10 ³ /μL	10 ⁹ /L	10 ⁹ /L	10 ³ /μL	10 ⁹ /L
RBC	10 ⁶ /μL	10 ¹² /L	10 ¹² /L	10 ⁶ /μL	10 ¹² /L
Plt	10 ³ /μL	10 ⁹ /L	10 ⁹ /L	10 ³ /μL	10 ⁹ /L
Hct	%	L/L	L/L	L/L	L/L
Hgb	g/dL	g/L	g/L	g/dL	mmol/L
MCV	fL	fL	fL	fL	fL
MCH	pg	pg	pg	pg	fmol
MCHC	g/dL	g/L	g/L	g/dL	mmol/L
RDW	%	%	%	%	%
MPV	fL	fL	fL	fL	fL
Pct	%	%	%	%	%
PDW	%	%	%	%	%
DIFF %	%	%	ratio	%	%
DIFF #	10 ³ /μL	10 ⁹ /L	10 ⁹ /L	10 ³ /μL	10 ³ /μL

Do this procedure to select a reporting unit format.

- 1** Beginning at the Main menu, select **SETUP ► UNITS**.

-
- 2 Move the cursor to the desired report unit format.

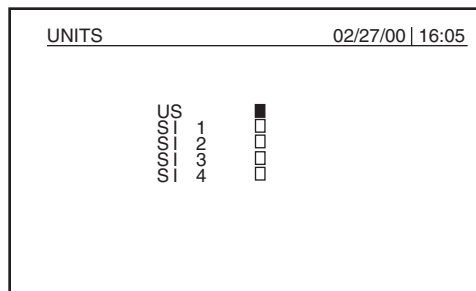

-
- 3 Press  to select the format.

-
- 4 Press  to save and exit.

A.8 LABORATORY LIMITS SETUP

The instrument provides the ability to define three separate sets of flagging criteria.

- Range 1 selects Patient Range 1 and Action Range 1.
- Range 2 selects Patient Range 2 and Action Range 2.
- Range 3 selects Patient Range 3 and Action Range 3.

This means that if you select Range 2, the sample results will be reported and flagged according to Patient Range 2 and Action Range 2.

Remember these range associations when establishing your laboratory limits and when selecting a range for analysis.

Patient Ranges

Your laboratory can define three separate patient ranges. If a result is outside the selected patient range, the result will be flagged:

- *H* for results above the upper limit, and
- *L* for results below the lower limit.

CBC and DIFF patient ranges are initially set to the default values shown in Tables A.3 and A.4. If you want to change the patient ranges:

- For CBC, do **Changing CBC Patient Ranges**.
- For DIFF, do **Changing DIFF Patient Ranges**.

Changing CBC Patient Ranges

Table A.3 shows the default patient ranges for CBC parameters.

Table A.3 CBC Default Patient Ranges

Parameter	CBC Range		
	Low Limit	High Limit	Unit
WBC	4.0	11.0	10 ³ /μL
RBC	4.00	6.20	10 ⁶ /μL
Hgb	11.0	18.8	g/dL
Hct	35.0	55.0	%
MCV	80	100	fL
MCH	26.0	34.0	pg
MCHC	31.0	35.0	g/dL
RDW	10.0	20.0	%
Plt	150	400	10 ³ /μL
MPV	6.0	10.0	fL
Pct	0.2	0.5	%
PDW	8.0	18.0	%

- 1 Beginning at the Main menu, select
SETUP ▶ LAB. LIMITS ▶ PATIENT RANGES
▶ CBC.

-
- 2** Press  to select the patient range (1, 2, or 3) to be changed.

The range number is displayed as *PATIENT RANGES X* (where X is the number).

CBC		02 / 27 / 00 16:05	
PATIENT RANGES 1			
WBC	4.0 ~ 11.0	PLT	150 ~ 400
RBC	4.00 ~ 6.20	MPV	6.0 ~ 10.0
HGB	11.0 ~ 18.8	PCT	0.2 ~ 0.5
HCT	35.0 ~ 55.0	PDW	8.0 ~ 18.0
MCV	80 ~ 100		
MCH	26.0 ~ 34.0		
MCHC	31.0 ~ 35.0		
RDW	10.0 ~ 20.0		

-
- 3** Move the cursor to the value to be changed.

-
- 4** Edit the value.



-
- 5** Press  to save.

The CBC Patient Ranges are now changed to reflect the new values you entered.

-
- 6** Repeat steps 3 and 4 as needed to change additional values for the patient range you selected in step 2.

-
- 7 Repeat steps 2 through 6 to change the other patient ranges, if required.
-

- 8 Press  to exit.

Changing DIFF Patient Ranges

Table A.4 shows the default patient ranges for DIFF parameters.

Table A.4 DIFF Default Patient Ranges

Parameter	DIFF Range		
	Low Limit	High Limit	Unit
NE%	50.0	80.0	%
LY%	25.0	50.0	%
MO%	2.0	10.0	%
EO%	0.0	5.0	%
BA%	0.0	2.0	%
ATL%	0.0	2.0	%
IMM%	0.0	2.0	%
NE#	2.00	8.00	10 ³ /μL
LY#	1.00	5.00	10 ³ /μL
MO#	0.10	1.00	10 ³ /μL
EO#	0.00	0.40	10 ³ /μL
BA#	0.00	0.20	10 ³ /μL
ATL#	0.00	0.20	10 ³ /μL
IMM#	0.00	0.20	10 ³ /μL

- 1 Beginning at the Main menu, select
SETUP ▶ **LAB. LIMITS** ▶ **PATIENT RANGES**
▶ **DIFF**

-
- 2** Press  to select the patient range (1, 2, or 3) to be changed.

The range number is displayed as *PATIENT RANGES X* (where X is the number).

DIFF		02 / 27 / 00 16:05	
PATIENT RANGES 1			
NE	50.0 ~ 80.0	NE#	2.00 ~ 8.00
LY	25.0 ~ 50.0	LY #	1.00 ~ 5.00
MO	2.0 ~ 10.0	MO#	0.10 ~ 1.00
EO	0.0 ~ 5.0	EO#	0.00 ~ 0.40
BA	0.0 ~ 2.0	BA#	0.00 ~ 0.20
	~		
ATL	0.0 ~ 2.0	ATL#	0.00 ~ 0.20
IMM	0.0 ~ 2.0	IMM#	0.00 ~ 0.20

-
- 3** Move the cursor to the value to be changed.

-
- 4** Edit the value.



-
- 5** Press  to save.
The DIFF Patient Ranges are now changed to reflect the new values you entered.

-
- 6** Repeat steps 3 and 4 as needed to change additional values for the patient range you selected in step 2.

7 Repeat steps 2 through 6 to change the other patient ranges, if required.

8 Press  to exit.

Action Ranges

Your laboratory can set three separate action ranges. If a result is outside the selected action range, the result will be flagged:

- *HH* for results above the upper limit, and
- *LL* for results below the lower limit.

CBC and DIFF action ranges are initially set to the default values shown in Tables A.3 and A.4. If you want to change the action ranges:

- For CBC, do **Changing CBC Action Ranges**.
- For DIFF, do **Changing DIFF Action Ranges**.

Changing CBC Action Ranges

Table A.5 shows the default action ranges for CBC parameters.

Table A.5 CBC Default Action Ranges

Parameter	CBC Range		
	Low Limit	High Limit	Unit
WBC	2.0	15.0	10 ³ /μL
RBC	2.50	7.00	10 ⁶ /μL
Hgb	8.5	20.0	g/dL
Hct	25.0	60.0	%
MCV	70	120	fL
MCH	25.0	35.0	pg
MCHC	28.0	38.0	g/dL
RDW	7.0	25.0	%
Plt	70	500	10 ³ /μL
MPV	5.0	12.5	fL
Pct	0.1	0.6	%
PDW	5.0	25.0	%

-
- 1 Beginning at the Main menu, select **SETUP** ► **LAB. LIMITS** ► **ACTION RANGES** ► **CBC**.
-

- 2 Press  to select the action range (**1**, **2**, or **3**) to be changed.
The range number is displayed as *ACTION RANGES X* (where X is the number).

CBC		02 / 27 / 00 16:05	
ACTION RANGES 1			
WBC	2.0 ~ 15.0	PLT	70 ~ 500
RBC	2.50 ~ 7.00	MPV	5.0 ~ 12.5
HGB	8.5 ~ 20.0	PCT	0.1 ~ 0.6
HCT	25.0 ~ 60.0	PDW	5.0 ~ 25.0
MCV	70 ~ 120		
MCH	25.0 ~ 35.0		
MCHC	28.0 ~ 38.0		
RDW	7.0 ~ 25.0		

-
- 3 Move the cursor to the value to be changed.
-

- 4 Edit the value.

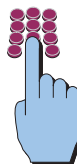

-
- 5 Press  to save.
The CBC Action Ranges are now changed to reflect the new values you entered.

6 Repeat steps 3 and 4 as needed to change additional values for the action range you selected in step 2.

7 Repeat steps 2 through 6 to change the other action ranges, if required.

8 Press  to exit.

Changing DIFF Action Ranges

Table A.6 shows the default action ranges for DIFF parameters.

Table A.6 DIFF Default Action Ranges

Parameter	DIFF Range		
	Low Limit	High Limit	Unit
NE%	45.0	85.0	%
LY%	15.0	55.0	%
MO%	1.0	12.0	%
EO%	0.0	8.0	%
BA%	0.0	5.0	%
ATL%	0.0	5.0	%
IMM%	0.0	5.0	%
NE#	1.50	9.00	10 ³ /μL
LY#	0.75	5.50	10 ³ /μL
MO#	0.00	1.10	10 ³ /μL
EO#	0.00	0.60	10 ³ /μL
BA#	0.00	0.30	10 ³ /μL
ATL#	0.00	0.60	10 ³ /μL
IMM#	0.00	0.60	10 ³ /μL

-
- 1 Beginning at the Main menu, select **SETUP ▶ LAB. LIMITS ▶ ACTION RANGES ▶ DIFF.**
-

- 2 Press  to select the action range (**1, 2, or 3**) to be changed.

The range number is displayed as *ACTION RANGES X* (where X is the number).

DIFF		02 / 27 / 00 16:05	
ACTION RANGES 1			
NE	15.0 ~ 85.0	NE#	1.50 ~ 9.00
LY	15.0 ~ 55.0	LY #	0.75 ~ 5.50
MO	1.0 ~ 12.0	MO#	0.00 ~ 1.10
EO	0.0 ~ 8.0	EO#	0.00 ~ 0.60
BA	0.0 ~ 5.0	BA#	0.00 ~ 0.30
	~		
ATL	0.0 ~ 5.0	ATL#	0.00 ~ 0.60
IMM	0.0 ~ 5.0	IMM#	0.00 ~ 0.60

-
- 3 Move the cursor to the value to be changed.
-

- 4 Edit the value.

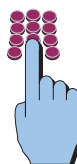

-
- 5 Press  to save.

The DIFF Action Ranges are now changed to reflect the new values you entered.

6 Repeat steps 3 and 4 as needed to change additional values for the patient range you selected in step 2.

7 Repeat steps 2 through 6 to change the other action ranges, if required.

8 Press  to exit.

A.9 SETTING FLAG SENSITIVITY AND THRESHOLDS

ATTENTION: This procedure must be done by a Beckman Coulter representative.

The instrument flags a sample if the sample results exceed specific criteria defined within the software.

The values used to position the thresholds, which separate different cell populations and determine if a flag should be triggered, are selected to provide optimal population separation and flagging under normal operating conditions. Contact a Beckman Coulter representative if you need to modify any of these values.

A.10 PRINTER CONFIGURATION

ATTENTION: Ensure that the printer is in Draft mode so that printouts, such as patient result reports, are formatted correctly. Refer to the printer's user manual for information on setting the printer to Draft mode.

Configuring the Instrument's Printer Settings

Configure the printer settings, including.

- *Paper length (inches):* 5.5", 6", 11", or 12".
- *Area printing:* options 1 through 3.
- *Patient range printout:* prints normal ranges.
- *Messages printout:* prints interpretive messages.
- *DiffPlot & histogram flags:* prints and displays the full format DiffPlot and histogram flags.
- *Histogram thresholds:* prints and displays the threshold positions on the WBC, RBC, and Plt histograms.
- *Print Raw Values:* prints raw data. Select this option only for troubleshooting purposes, not for routine operation.
- *Zoomed Print Screen:* allows large printout of screen display.
- *Disable printer:* Does not print the results and does not sound a printer alarm.

Figure A.1 is an example of a sample results printout.

Figure A.1 Sample Results Report: Areas Defined

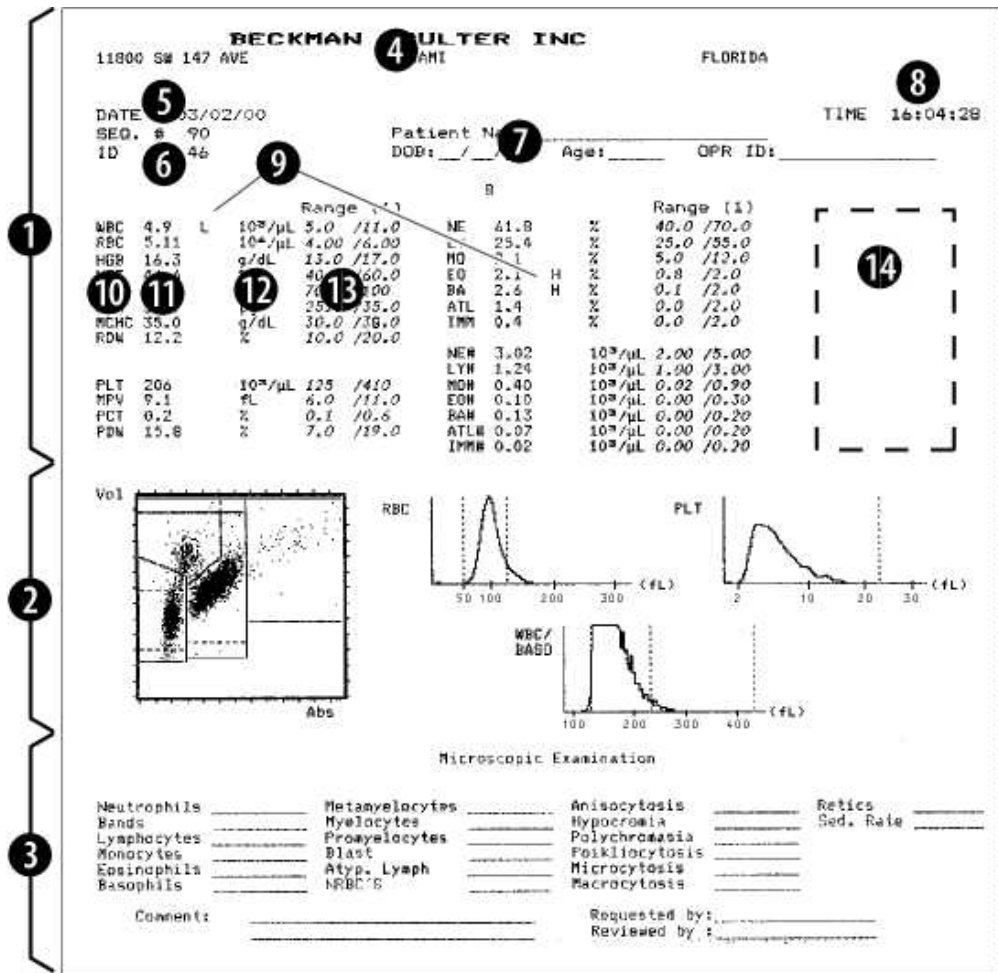

7615068B

- 1 Area 1 of the report. (See *Printing Options*.)
- 2 Area 2 of the report. (See *Printing Options*.)
- 3 Area 3 of the report. (See *Printing Options*.)
- 4 Header. (See *Heading A.11, ENTERING/EDITING THE INSTITUTIONAL HEADER*.)
- 5 Date. (See *Heading A.6, DATE/TIME SETUP*.)
- 6 Sample ID. [See *Heading A.14, SELECTING THE SAMPLE IDENTIFICATION (ID) MODE*]
- 7 Patient information. (Written or typed by the operator after the report is printed.)
- 8 Time. (See *Heading A.6, DATE/TIME SETUP*.)
- 9 Flags. (See *Chapter 6, REVIEWING RESULTS*.)
- 10 Parameter. (See *Parameters*.)
- 11 Result. (Displayed in the selected format. See *Heading A.7, REPORTING UNIT SELECTION*.)
- 12 Reporting unit. (See *Heading A.7, REPORTING UNIT SELECTION*.)
- 13 Range. (See *Heading A.8, LABORATORY LIMITS SETUP*.)
- 14 Other flagging information and interpretive messages, if any.

Printing Options

There are three report printing options. The option you choose determines which areas (Figure A.1) will print on the report.

- *Option 1* prints report areas 1, 2, and 3.
- *Option 2* prints report areas 1 and 2.
- *Option 3* prints report area 1.

Do this procedure to configure the printer.

- 1 Beginning at the Main menu, select **SETUP » PRINTER » PRINTER CONFIGURATION**.

PRINTER CONFIGURATION		02/27/00 16:05
PAPER LENGTH (INCHES)	AREA PRINTING	
5.5" <input type="checkbox"/>	OPTION 1 <input checked="" type="checkbox"/>	
6" <input type="checkbox"/>	OPTION 2 <input type="checkbox"/>	
11" <input checked="" type="checkbox"/>	OPTION 3 <input type="checkbox"/>	
12" <input type="checkbox"/>		
PATIENT RANGE PRINTOUT	<input checked="" type="checkbox"/>	
MESSAGES PRINTOUT	<input checked="" type="checkbox"/>	
DIFFPLOT & HISTOGRAM FLAGS	<input type="checkbox"/>	
HISTOGRAM THRESHOLDS	<input type="checkbox"/>	
PRINT RAW VALUES	<input type="checkbox"/>	
ZOOMED PRINT SCREEN	<input type="checkbox"/>	
DISABLE PRINTER	<input type="checkbox"/>	

- 2 Move the cursor to the parameter you want to select or de-select.

- 3 Press  at an empty box to make the selection. To de-select that box, select something else.

- 4 Repeat steps 2 and 3 as needed.

- 5 Press  to save and exit.

Note: If paper length is changed, turn the printer off then on to activate the new length so the form feeds correctly.

A.11 ENTERING/EDITING THE INSTITUTIONAL HEADER

Do this procedure to define the header that will appear on the sample reports. You can enter up to four lines of text with 32 characters per line.

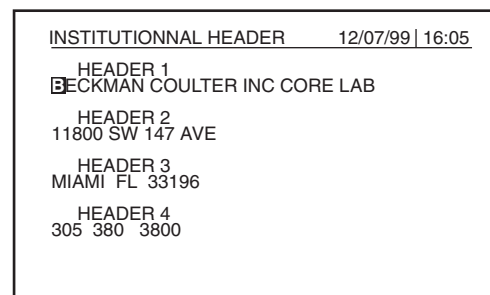

- 1 Beginning at the Main menu, select **SETUP** ► **PRINTER** ► **INSTITUTIONAL HEADER**.

- 2 Move the cursor to where you want to enter information.



- 3 Press . The cursor becomes a flashing underscore to let you edit the field.

- 4 Enter the header text:

- Press  or  to display alpha characters.
- Enter numbers at the numeric keypad.

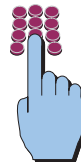

- 5 Press  to accept your changes and to move the cursor to the next line.
-

- 6 Repeat steps 2 through 5 as needed.
-

- 7 Press  to exit.

A.12 PRINTING A SYSTEM SETUP REPORT

After changing the instrument's setup, print a system setup report, which details your instrument's setup configuration. Keep the report for your records.

Note: Regarding printing reagent lot numbers, only the lot numbers for the reagents currently in use will print.

- 1 Beginning at the Main menu, select **SETUP ► OTHERS ► PRINT SYSTEM SETUP**.
-
- 2 The system setup report prints.
Note: It may take several minutes to print; this report consists of several pages.
-
- 3 Keep the system setup report for your records.

A.13 CALIBRATION SETUP

Changing CV% Limits

This feature allows you to set the upper limits of the CVs for each parameter used in calculating the CV%. When calibration CV results are not within these limits, an *HH* flag appears next to the CV value. Table A.7 shows the default CV limits. (Note: The default values are selected for optimal performance. It is strongly recommended that you consult a Beckman Coulter representative prior to changing the CV% limits.)

The default limits are defined for a system that has been correctly maintained and for a system using Beckman Coulter recommended reagents and calibrators.

Table A.7 Default CV Limits

CV% Limits	Default	Minimum	Maximum
WBC	2	1	3
RBC	2	1	3
Hgb	1	1	2
Hct	2	1	3
Plt	5	3	7

Note: A user password is required for this procedure.

1 Beginning at the Main menu, select
**SETUP ▶ OTHERS ▶ CALIBRATION ▶
CV% LIMITS.**

2 Enter the user password, and press



-
- 3** Move the cursor to the value you want to edit.

CV% LIMITS		1 / 27 / 00 16:05
WBC	CV LIMIT 2.0	
RCB	CV LIMIT 2.0	
HGB	CV LIMIT 1.0	
HCT	CV LIMIT 2.0	
PLT	CV LIMIT 5.0	

-
- 4** Edit the value.

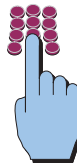

-
- 5** Press  to save the value entered and to move to the next field.

-
- 6** Repeat steps 3 through 5 as needed.

-
- 7** Press  to exit.

Defining the Operator

An operator ID is associated with performing calibration functions. You can change the code used to identify the operator on the screen. The selection of the operator doing calibration is done during calibration and recorded with the calibration results.

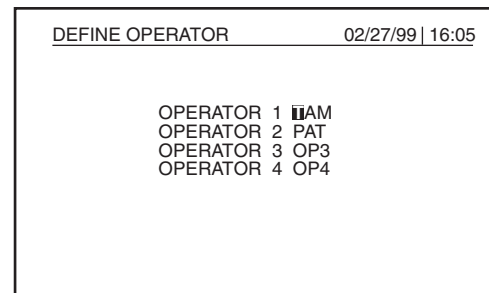

- 1 Beginning at the Main menu, select **SETUP** **»** **OTHERS** **»** **CALIBRATION** **»** **DEFINE OPERATOR**.





- 2 Move the cursor to the Operator ID you want to edit.

- 3 Press . The cursor becomes a flashing underscore to let you edit the field.

- 4 Edit the operator definition by entering up to eight alphanumeric characters.

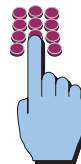
- Press  or  to display alpha characters.
- Enter numbers at the numeric keypad.



-
- 5** Press  to accept the changes and to move to the next operator field.

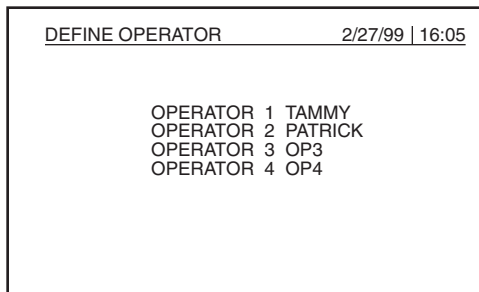

-
- 6** Repeat steps 2 through 5 until all operators have been defined.



-
- 7** Press  to save and exit.

A.14 SELECTING THE SAMPLE IDENTIFICATION (ID) MODE

Before you analyze a sample, a sample ID is required. You can manually enter the sample ID, scan the barcode ID from the sample tube using the optional barcode reader, or have the instrument automatically assign (auto-number) the sample ID.

- If you select *Manual*, you are required to enter an ID before running the sample. Enter a sample ID by entering numbers at the numeric keypad or by selecting alpha characters using  or .
- If you select *Autonumbering*, the ID number is automatically incremented by 1 from the previously assigned number each time a sample is analyzed.

Do this procedure to select the sample ID mode (manual or autonumber) that you will use. If you want to use the optional barcode reader, you do not have to do this procedure.

-
- 1 Beginning at the Main menu, select **SETUP ► OTHERS ► IDENTIFICATION MODE**.

-
- 2 Move the cursor to *Manual ID Mode* or *Autonumbering Mode*.

IDENTIFICATION MODE	02/27/00 16:05
MANUAL ID MODE	<input type="checkbox"/>
AUTONUMBERING MODE	<input checked="" type="checkbox"/>
BAR CODE WITH CHECKSUM	<input checked="" type="checkbox"/> [RESET]
SEQUENCE NUMBER	51
IDENTIFICATION NUMBER	1009
RESET TIME 07:30	AM <input checked="" type="checkbox"/> PM <input type="checkbox"/>
DISPLAY DIFF #	<input type="checkbox"/>
ENABLE ATL, IMM, PCT, PDW	<input type="checkbox"/>

-
- 3 Press .

-
- 4 Press  to exit and save the changes.

A.15 DISPLAYING DIFF # OR DIFF %

Do this procedure to select how you want the DIFF results displayed on the sample results screen. *DIFF %* is the default setting.

- 1 Beginning at the Main menu, select **SETUP » OTHERS » IDENTIFICATION MODE**.

- 2 Select the DIFF display option:

- To display the DIFF absolute counts, move the cursor to

DISPLAY DIFF # and press .

- To display the DIFF percentage values, do not select *DISPLAY DIFF #*.

Note: Regardless of what you select here, the percentage and absolute count both print on the report.

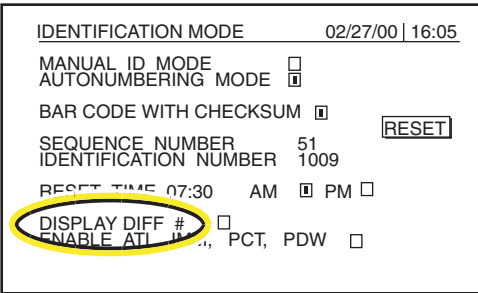

```
IDENTIFICATION MODE 02/27/00 | 16:05
MANUAL ID MODE 
AUTONUMBERING MODE 
BAR CODE WITH CHECKSUM 
SEQUENCE NUMBER 51
IDENTIFICATION NUMBER 1009
RESET TIME 07:30 AM  PM 
DISPLAY DIFF # 
ENABLE ATL IMM, PCT, PDW 
```

- 3 Press  to exit and save the changes.

A.16 ENABLING ATL, IMM, PCT, AND PDW

Do this procedure to enable ATL, IMM, Pct, and PDW results.

- 1 Beginning at the Main menu, select **SETUP » OTHERS » IDENTIFICATION MODE**.

- 2 Move the cursor to the *ENABLE ATL, IMM, PCT, PDW* feature.

IDENTIFICATION MODE	02/27/00 16:05
MANUAL ID MODE	<input type="checkbox"/>
AUTONUMBERING MODE	<input checked="" type="checkbox"/>
BAR CODE WITH CHECKSUM	<input checked="" type="checkbox"/> RESET
SEQUENCE NUMBER	51
IDENTIFICATION NUMBER	1009
RESET TIME 07:30	AM <input checked="" type="checkbox"/> PM <input type="checkbox"/>
DISPLAY DIFF #	<input type="checkbox"/>
ENABLE ATL, IMM, PCT, PDW	<input checked="" type="checkbox"/>

- 3 Press .

- 4 Press  to save and exit.

A.17 RESETTING THE MANUAL SAMPLE ID NUMBER AND INSTRUMENT SEQUENCE NUMBER TO "1"

The instrument sequence number, which indicates the number of cycles analyzed, is instrument generated and is independent of the sample ID. The sequence number automatically resets to 1 at the reset time shown, which can be user defined.

Do this procedure to reset the manual sample ID number and instrument sequence number to one.

- 1 Beginning at the Main menu, select **SETUP ► OTHERS ► IDENTIFICATION MODE**.

IDENTIFICATION MODE	02/27/00 16:05
MANUAL ID MODE	<input type="checkbox"/>
AUTONUMBERING MODE	<input checked="" type="checkbox"/>
BAR CODE WITH CHECKSUM	<input checked="" type="checkbox"/> RESET
SEQUENCE NUMBER	51
IDENTIFICATION NUMBER	1009
RESET TIME 07:30	AM <input checked="" type="checkbox"/> PM <input type="checkbox"/>
DISPLAY DIFF #	<input type="checkbox"/>
ENABLE ATL, IMM, PCT, PDW	<input type="checkbox"/>

2 Highlight **RESET** and press .

3 Press  to exit and save the changes.

A.18 SELECTING BARCODE WITH CHECKSUM

If you are using the optional barcode reader, do this procedure to select or de-select the barcode checksum. **Note:** The barcode with checksum default is *selected*, which is recommended.

1 Beginning at the Main menu, select **SETUP** ► **OTHERS** ► **IDENTIFICATION MODE**.

2 Move the cursor to the checksum field.

3 Press .

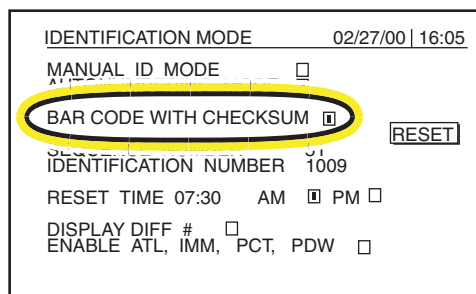

4 Press  to exit and save the changes.

A.19 AUTO-CLEAN FREQUENCY SETTING

The instrument automatically performs an autoclean cycle after a specified number of analyses. The default number of analyses is 75. You can change this number to be any number from 1 to 75. For example, if you want the instrument to run the autoclean cycle after 50 analyses, then you would change the number to 50.

Do this procedure to change the autoclean frequency.

- 1 Beginning at the Main menu, select **SETUP ▶ OTHERS ▶ AUTOCLEAN FREQUENCY**.

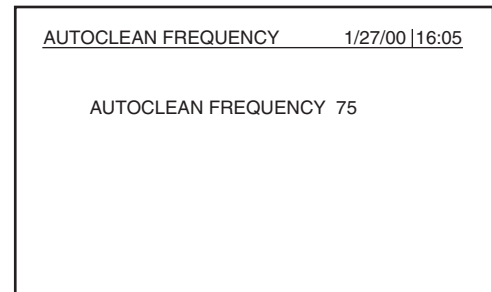

- 2 Edit the number (from 1 to 75).

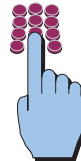

- 3 Press  to save the changes.

- 4 Press  to exit and save the changes.

A.20 CHANGING THE DAILY WORKLOAD

You can enter the daily workload (approximate number of CBC and CBC/DIFF analyses performed each day), which the instrument will use to perform a reagent capacity check at the end of a Startup to determine if there is enough reagent to last throughout a workday. Table A.8 shows the default workload values for the CBC and CBC/DIFF modes.

If the instrument determines that there is not enough reagent to complete the day's work, a *REAGENT LOW LEVEL* message is displayed. You can either determine which reagent is low and change the reagent, or continue working until the specific *REAGENT LOW LEVEL (X)* message is displayed. (X refers to the specific reagent.)

Table A.8 Daily Workload Runs by Mode

Mode	Default	Minimum	Maximum
CBC	10	1	500
CBC/DIFF	40	1	500

- 1 Beginning at the Main Menu, select **REAGENTS ► DAILY WORKLOAD**.

- 2 Move the cursor to the appropriate field.

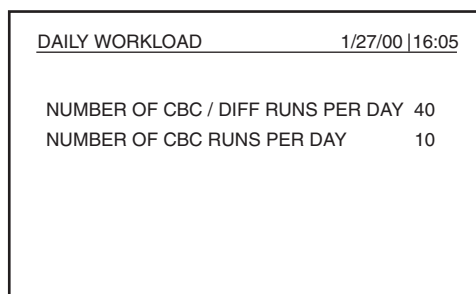

- 3 Change the number of runs.

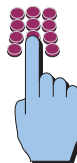

4 Press  to save.

5 Press  to exit.

A.21 REAGENT VOLUMES SETUP

This feature defines the initial volumes of each reagent bottle/container. This information is used to calculate reagent consumption based on the number of analyses performed and to determine the reagent volume remaining in each reagent bottle/container.

Table A.9 shows the default volumes for each reagent.

Table A.9 Default Reagent Volumes

Reagent	Standard Volume (mL)	Minimum	Maximum
Diluent	20,000	1,000	30,000
Fix	1,000	100	5,000
WBC Lyse	1,000	100	5,000
Hgb Lyse	400	100	2,000
Rinse	1,000	100	5,000

ATTENTION: Default values (Table A.9) are based on the bottle/container volume for Beckman Coulter-recommended reagents. Changing these values may cause reagents to run out without displaying a *REAGENT LOW LEVEL* message.

1 Beginning at the Main menu, select **SETUP ► OTHERS ► REAGENT VOLUMES.**

REAGENT VOLUMES		02 / 27 / 00 16:05
STANDARD VOLUME (ml)		
DILUENT	20000	
RINSE	1000	
FIX	1000	
WBC LYSE	1000	
HGB LYSE	400	

2 Move the cursor to the value to be changed.

3 Edit the values.

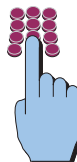

4 Press  to save the changes and to move the cursor to the next field.

5 Repeat steps 2 through 4 to change other reagent volumes, if necessary.

6 Press  to exit.

A.22 VIEWING THE CYCLE COUNT

Beginning at 1, the instrument counts the number of cycles run after the software is installed for:

- CBC/DIFF,
- CBC,
- Startup,
- Shutdown, and
- System Reset Cycle.

Do this procedure to review the number of cycles analyzed by the instrument.

-
- 1** Beginning at the Main menu, select **SETUP ▶ OTHERS ▶ CYCLE COUNTS**.

-
- 2** The number of analyzed cycles is displayed.

CYCLE COUNTS		1 / 27 / 00 16:05
CBC / DIFF	# 1395	
CBC	# 144	
STARTUP	# 100	
SHUTDOWN	# 43	
SYSTEM RESET	# 31	

-
- 3** Press  to exit.

INSTRUMENT SETUP
VIEWING THE CYCLE COUNT

This Appendix contains these Log Sheets.

Action Log

Maintenance Log

Reagent Log

Photocopy these log sheets as needed.

C.1 ANALYSIS PROCEDURE

Use a material with known reference values as your calibrator.

- 1 Be sure you have done **Heading 7.2, PRE-CALIBRATION CHECKS.**

- 2 Prepare your material as needed.

- 3 Present the well-mixed material to the probe so that the tip is well into the tube, and press the aspirate switch.

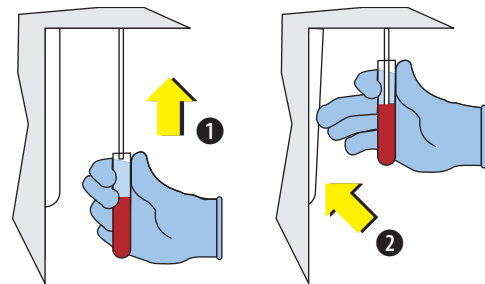

- 4 Record the results on the calibration worksheet.

CALIBRATION WORKSHEET					
Sample Number	WBC	RBC	Hgb	Hct	Pt
1					
2					
3					
4					
5					
6					
7					
8					
9					
10					
11					
TOTAL					
MEAN (A)					
ASSIGNED VALUE (B)					
ABSOLUTE DIFFERENCE (C)					
CALIBRATION REQUIRED					
CURRENT CALIBRATION FACTOR (D)					
NEW CALIBRATION FACTOR (E)					

$C = B - A$
 $E = (B / A) \times D$

- 5 Repeat steps 3 and 4 ten more times, for a total of 11 runs.

- 6** Do *Heading C.2, CALCULATIONS PROCEDURE*.

C.2 CALCULATIONS PROCEDURE

- 1** Calculate the mean for each parameter using samples 2 through 11 on the worksheet. Write this number into row A on the worksheet.
-
- 2** Copy your calibrator material's assigned value to the worksheet. Write this number into row B on the worksheet.
-
- 3** Calculate the absolute difference between the assigned value and the mean value calculated in step 1. Write this number into row C of the worksheet.

-
- 4 Determine if calibration is necessary by comparing the absolute difference from row C to your material's calibration criteria table.
- If the absolute difference is less than the value in your material's calibration criteria table, no calibration is required.
 - If the absolute difference is between the values found in your material's calibration criteria table, do **Heading C.3, CALCULATING NEW CALIBRATION FACTORS**.
 - If the absolute difference is greater than the value found in your material's calibration criteria table, eliminate possible instrument problems and possible calibrator deterioration. If you determine calibration may be needed, contact a Beckman Coulter Representative before calibrating.

C.3 CALCULATING NEW CALIBRATION FACTORS

- 1 Do **Heading 7.4, MANUAL CALIBRATION FACTOR ADJUSTMENT**.
-
- 2 Record these factors into row D on the worksheet.

Calibration Worksheet

Sample Number	WBC	RBC	Hgb	Hct	Plt
1					
2					
3					
4					
5					
6					
7					
8					
9					
10					
11					
TOTAL					
MEAN (A)					
ASSIGNED VALUE (B)					
ABSOLUTE DIFFERENCE (C)					
CALIBRATION REQUIRED					
CURRENT CALIBRATION FACTOR (D)					
NEW CALIBRATION FACTOR (E)					

A = samples 2 through 11

C = B - A

E = (B / A) x D

D.1 TROUBLESHOOTING FLOWCHART

See Figure D.1 for troubleshooting information.

Figure D.1 Troubleshooting Flowchart

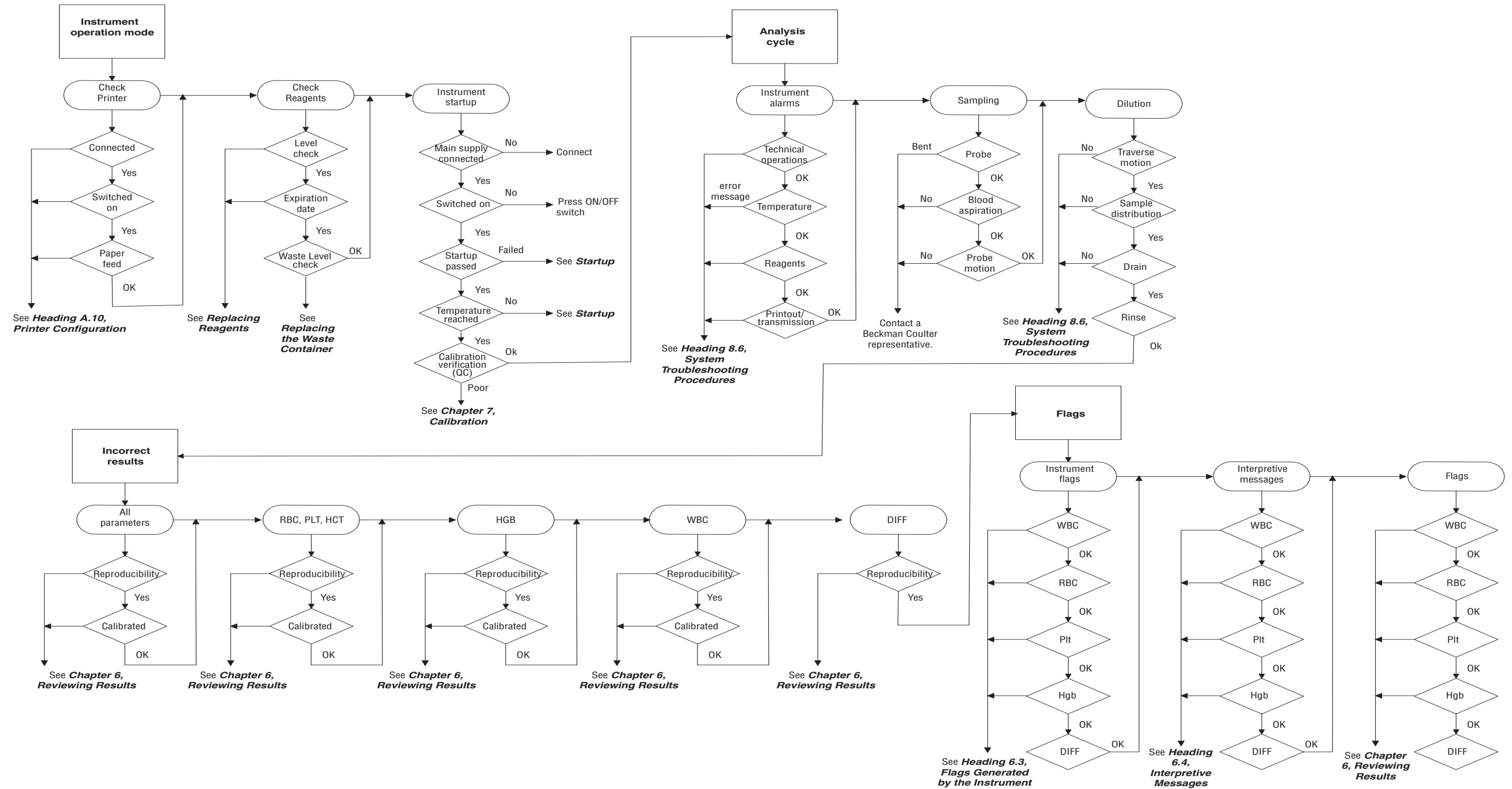

E.1 INSTALLATION

- Install the instrument according to the instructions in the service manual.

E.2 GENERAL

- Describe the intended use of the instrument, including the parameters analyzed, displayed, and printed.
- Review the Operator's Guide and reference materials as needed.

E.3 SAMPLE HANDLING

- Review the requirements for specimen collection, sample handling, storage, and mixing for venous and microcollection samples.

E.4 INSTRUMENT COMPONENTS

Identify and locate the following instrument components:

- | | |
|--|--|
| <input type="checkbox"/> On/Off switch | <input type="checkbox"/> Aspirate switch |
| <input type="checkbox"/> Reagent compartment | <input type="checkbox"/> Sampling probe |
| <input type="checkbox"/> Diluter assembly | <input type="checkbox"/> Baths (5) |
| <input type="checkbox"/> Diluent Reservoir | <input type="checkbox"/> Printer |

E.5 SOFTWARE MENU

Describe the software menu options:

- | | |
|------------------------------------|--------------------------------------|
| <input type="checkbox"/> Main Menu | <input type="checkbox"/> Calibration |
| <input type="checkbox"/> Reagents | <input type="checkbox"/> Diagnostics |
| <input type="checkbox"/> Setup | |

E.6 REAGENTS

Identify and locate each reagent and provide replacement instructions.

- | | | |
|--|--|---|
| <input type="checkbox"/> AC•T 5diff Diluent | <input type="checkbox"/> AC•T 5diff Fix | <input type="checkbox"/> AC•T 5diff Rinse |
| <input type="checkbox"/> AC•T 5diff WBC Lyse | <input type="checkbox"/> AC•T 5diff Hgb Lyse | |

E.7 INSTRUMENT SETUP/CUSTOMIZATION

Review and assist as needed.

- Date/Time
- Units
 - US
 - SI1
 - SI2
 - SI3
 - SI4
- Lab Limits
 - Patient ranges
 - Action ranges
 - Flags/Sensitivity
 - Thresholds
- Host Setup
 - Host Configuration
 - Sending Configuration
 - Sending Options
 - Variable Format Setup
 - Send Latest Results
- Printer
 - Printer Configuration
 - Print Setup Report
 - Institutional Header
 - Print Latest Results
- Others:
 - Calibration
 - Identification Mode
 - Autoclean Frequency
 - Change Password
 - Language
 - Reagent Volumes
 - Cycle Counts

E.8 CALIBRATION

- Review the instrument's pre-calibration status.
- Review recommendations and frequency.
- Locate and discuss procedure for future use.

E.9 CONTROLS

Review and assist as needed.

- Importance of quality control
- Running controls
- Control handling techniques
- Stability

E.10 SYSTEM OPERATION OVERVIEW

- Sample flow and distribution
- Sampling probe
- RUO parameters (USA only)
- Sample aspiration (volume)
- Results (displayed/printed)
- Sample dilution
- Printer operation

E.11 DAILY PROCEDURES

- Startup procedure and background tests
- Sample results
- Shutdown procedure
- Sample ID (manual, autonumbering, or barcode)
- Parameter flags and codes
- Running samples
- Irregular sample results

E.12 SPECIAL PROCEDURES

Review and assist as needed.

- | | | |
|--|--|--|
| <input type="checkbox"/> General maintenance | <input type="checkbox"/> Cycle counter | <input type="checkbox"/> Cleaning procedures |
| <input type="checkbox"/> Reagent replacement | <input type="checkbox"/> Waste container replacement | <input type="checkbox"/> Flowcell lamp replacement |

E.13 MAINTAINING AND SERVICING THE INSTRUMENT

- Importance of “general maintenance”.
- Telephone troubleshooting availability and its importance for minimizing downtime.
- Service procedures and expectations.

E.14 PAPERWORK

- | | | |
|--|--|--|
| <input type="checkbox"/> Log sheets (Appendix B) | <input type="checkbox"/> Purpose of documenting daily procedures, controls, reagents, and maintenance. | <input type="checkbox"/> Ensure customer service telephone number is clearly noted. |
| <input type="checkbox"/> Complete this training checklist (installer and customer). Customer should keep this in laboratory logbook. | <input type="checkbox"/> Attach a copy of control results (all levels) to this checklist. | <input type="checkbox"/> Attach copy of Setup Report to this checklist. |
| <input type="checkbox"/> Complete a training certificate (if applicable) and leave it with the customer. | <input type="checkbox"/> Review Factory Calibration data. | <input type="checkbox"/> Complete the RUO Certification form (PN 4277094) and return it to Beckman Coulter, Inc. (customers in USA only) |

Install date: _____	Training date: _____
OPERATOR	BECKMAN COULTER REPRESENTATIVE
Name: _____ (Print)	Name: _____ (Print)
Title: _____	Title: _____
Signature: _____	Signature: _____

Thank you for purchasing the BECKMAN COULTER™ AC•T™ 5diff hematology analyzer.

TRAINING CHECKLIST
PAPERWORK

F.1 OVERVIEW

Use the information in this appendix to test, troubleshoot, and reprogram your barcode scanner.

IMPORTANT Risk of sample mis-identification if your barcode labels do not meet the specifications stated in this appendix. Use only barcode labels that meet the stated specifications.

Definition

A barcode consists of black lines (bars) and white lines (spaces) called elements.

ATTENTION: Beckman Coulter recommends that you verify each barcode reading to ensure correct sample identification.

F.2 BARCODE LABELS

Symbologies

The A^C•T 5diff analyzer accepts six barcode symbologies:

- Code 128,
- Code 39,
- Codabar,
- Interleaved 2-of-5,
- EAN 8, and
- EAN 13.

ATTENTION: The scanner uses Code 128 symbology for programming. Therefore, the following Code 128 characters must not be used in any of the barcodes used to identify the sample: \$, +, and –.

F.3 BARCODE SPECIFICATIONS

Barcode labels to be used with the A^C•T 5diff analyzer must meet the following specifications.

- Maximum number of usable characters in barcode label: 16.
- Minimum % PCS (Print Contrast Signal): 15% at 670 nm.
- Maximum resolution of scanner: 0.1 mm (4 mils).
- Maximum label length: 66 mm (2.6 inches).
- Code 128 barcode labels must meet European Standard EN 799.
- Code 39 barcode labels must meet European Standard EN 800.
- Codabar barcode must meet European Standard EN 798.
- Interleaved 2-of-5 (I 2-of-5) barcode labels must meet European Standard EN 801.
- EAN 8 barcode labels must meet EAN (European Article Numbering) Specifications.
- EAN 13 barcode labels must meet EAN (European Article Numbering) Specifications.

Table F.1 shows default barcode settings for each symbology.

Table F.1 Default Barcode Settings

Setting	Code 128^❶	Code 39	Codabar	I 2-of-5	EAN 8	EAN 13
Character Length	1 to 16	1 to 16	3 to 16	11 ^❸	7	12
Check Digit (Checksum) ^❷	Always Enabled	Enabled	Not Available	Enabled	Always Enabled	Always Enabled
Start/Stop Equality Check	Not Available	Not Available	Enabled	Not Available	Not Available	Not Available
Start/Stop Equality Output	Not Available	Not Available	Disabled	Not Available	Not Available	Not Available

^❶ Code 128 provides excellent density, alphanumeric characters, and good security. Recommend using this symbology if using barcodes for the first time, and if compatible with other bar code systems used in your lab.

^❷ For increased sample identification integrity, always use Check Digit (Checksum).

^❸ Number of characters for I 2-of-5 can be programmed for other lengths, including variable length. However, the variable length is NOT recommended for I 2-of-5 due to the possibility of capturing a partial read of the bar code label.

F.4 BARCODE LABEL TEST PAGES

See Tables F.2 and F.3.

Table F.2 Test Labels With the Check Digit (Checksum)







 <p>Code 128</p>	 <p>EAN 8 Reads 123456770</p>
 <p>Code 39</p> <p>If this label is read with Check Digit disabled, the last character "\$" is also displayed</p>	 <p>EAN 13 Reads 12345678901228</p>
 <p>Interleaved 2-of-5. Reads 11 characters with Check Digit or reads 12 characters without Check Digit.</p>	

Table F.3 Test Labels Without the Check Digit

 <p>Code 39</p> <p>Label will not read if scanner is programmed to default condition.</p>
 <p>Codabar</p>

F.5 BARCODE SCANNER CONFIGURATION

To restore the barcode scanner to default settings, read each bar code from top to bottom on each column of Table F.4 until all bar codes are read.

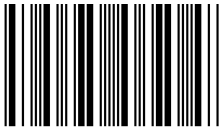
Bar codes with S+ and S- will sound multiple beeps when read. Other codes will only sound a single beep.

Table F.4 Barcode Scanner Configuration Sheet

\$+CQ0\$-	&B13AB*0116	EB3EHB54FF
\$+CP0\$-	&C131212	EB3EHNFFFF
\$+\$*	&I11	EB3EHVFFFF
\$+\$	&D121AD*0316	EB3EHRFFFF
CA0CC1CE2	&A110DEC0	EB3EHTFFFF
&Z0A,A3	EB3EHA45FF	\$-\$

F.6 CODE 39 AND CODABAR BARCODE SCANNER OPTIONS

- For Code 39, see Table F5, Code 39 Barcode Scanner Options.
- For Codabar, see Table F6, Codabar Barcode Scanner Options.

Table F.5 Code 39 Barcode Scanner Options

Read ONE of the labels below to set Check Digit control option



Code 39 No Check Digit control



Code 39 Check Digit control

Table F.6 Codabar Barcode Scanner Options

Read ONE of the labels below to set Start/Stop Equality option check



No Start/Stop equality check nor transmission



No Start/Stop equality check but transmission



Start/Stop equality check but no transmission



Start/Stop equality check and transmission

F.7 I 2-OF-5 PROGRAMMING OPTIONS AND TEST LABELS

See Table F.7.

Table F.7 Interleaved 2-of-5 Options With Fixed Length Characters Test Labels

Number of Characters (Check Digit or No Check Digit)	With Check Digit	No Check Digit	Fixed Digit Test Labels
	Read this label first, then ONE of the other labels below 	Read this label first, then ONE of the other labels below 	
3 or 4			
5 or 6			
7 or 8			
9 or 10			
11 or 12			
13 or 14			

BARCODE SPECIFICATIONS*1 2-OF-5 PROGRAMMING OPTIONS AND TEST LABELS***Table F.7 Interleaved 2-of-5 Options With Fixed Length Characters Test Labels (Continued)**

15 or 16	 §+AC131616§-	 §+AC111616§-	 1234567890123452
3 to 15 or 4 to 15	 §+AC130416§-	 §+AC110416§-	

Note: Variable Length Characters are NOT recommended for Interleaved 2-of-5 Barcodes. To increase sample identification integrity, use fixed length characters with Check Digit. If the test label fails to read, reset the scanner by turning the instrument off then on and repeating the programming sequence.

LIST OF REFERENCES

1. Coulter WH. High speed automatic blood cell counter and cell size analyzer. Paper presented at National Electronics Conference, Chicago, IL, 1956; October 3.



REFERENCES

LIST OF REFERENCES

DEFINITIONS

accuracy	Ability of the instrument to agree with a predetermined reference value at any point within the operating range; closeness of a result to the true (accepted) value.
agglutination	clump
background count	Measure of the amount of electrical or particle interference.
blank cycle	Runs diluent through the system to clean it out.
calibration	A procedure to standardize the instrument by determining its deviation from calibration references and applying any necessary correction factors.
calibration factors	These are correction factors that the system uses to fine-tune instrument accuracy.
calibrator	A substance traceable to a reference method for preparation or material used to calibrate, graduate, or adjust measurement.
carryover	The amount, in percent, of blood cells of Hgb remaining in diluent following the cycling of a blood sample.
cell control	A preparation made of human blood with stabilized cells and surrogate material used for daily instrument quality control.
characteristics	See performance characteristics.
coefficient of variation	An expression in percent of data (SD) spread related to the mean. $CV\% = (SD/mean) \times 100$
control	A substance used for monitoring the performance of an analytical process or instrument.
conventions	A standard style or format used in a manual.
CV	See coefficient of variation.
default	An original, factory-setting.
expiration date	The last day that you can use that specific lot number of reagent, control, or calibrator.
fL	Abbreviation for femtoliter.
femtoliter	One quadrillionth (10^{15}) of a liter.
field	An area on a screen for entering data.
flags	On printouts, letters or symbols that appear next to parameter results to indicate specific conditions. For additional information, see Heading 6.2, FLAGS AND INTERPRETIVE MESSAGES.
linearity	The ability of an instrument to recover expected results (reference values or calculated values) for such parameters as WBC, RBC, Hgb, and Plt, at varying levels of concentration of these parameters within specified limits.
lot number	A manufacturer's code that identifies when the product, such as a reagent, was manufactured.
mean	Arithmetic average of a group of data.
operating range	Range of results over which the instrument displays, prints, and transmits data.
parameter	A component of blood that the instrument measures and reports.
performance characteristics	Actual performance of the instrument.

performance specifications	Targeted performance of the instrument based on established ranges and parameters.
precision	A measure of reproducibility, precision is the ability of the instrument to reproduce similar results when a sample is repeatedly run. Precision of the instrument is a CV%, or an SD for DIFF parameters, based on replicate determinations of the same sample. Precision shows the closeness of test results when repeated analyses of the same material are performed.
quality control (QC)	A comprehensive set of procedures a laboratory establishes to ensure that the instrument is working accurately and precisely.
reproducibility	This procedure checks that the system gives similar results (within established limits) every time it measures the same sample. <i>Also called</i> precision.
SD (standard deviation)	A measure of variation within a group of samples or within a population.
shutdown cycle	Cleans the instrument's fluidic lines and apertures to help prevent residue buildup.
specifications	<i>See</i> performance specifications.
startup cycle	Ensures that the instrument is ready to run; includes performing a background test.
TABLE OF EXPECTED RESULTS	Assigned values for a control material used for quality control parameters. Usually reported on package insert shipped with the control material; can be a separate assay sheet.
verification	Procedure to analyze cell controls or whole blood with known values to determine if your results are within expected range.
whole blood	Non-diluted blood; blood and anticoagulant only.

LIST OF ABBREVIATIONS

μL	microliter
ACD	acid-citrate-dextrose
ANSI	American National Standards Institute
ASTM	American Society for Testing and Materials
BA	basophil
bps	bits per second
CBC	complete blood count
cm	centimeter
CV	coefficient of variation
DIFF	differential
dL	deciliter
EDTA	ethylenediaminetetraacetic acid
EO	eosinophil
fL	femtoliter
ft	foot or feet
g	gram
gal	gallon
GR	granulocyte
Hct	hematocrit
Hgb	hemoglobin
Hz	hertz
L	liter
LCD	liquid crystal display
LED	light-emitting diode
LY	lymphocyte
m	meter
MCH	mean corpuscular hemoglobin
MCHC	mean corpuscular hemoglobin concentration
MCV	mean corpuscular volume
mL	milliliter
mm	millimeter
MO	monocyte
MPV	mean platelet volume
MSDS	material safety data sheet
mW	milliwatt
n	number

ABBREVIATIONS
LIST OF ABBREVIATIONS

NCCLS	National Committee for Clinical Laboratory Standards
NE	neutrophil
nm	nanometer
pg	picogram
Plt	platelet
RBC	red blood cell
RDW	red cell distribution width
SD	standard deviation
Vac	volts of alternating current
Vdc	volts of direct current
WBC	white blood cell

Symbols

- *
 - definition, 6-3
- *BASO+
 - definition, 6-8
- *WBC
 - definition, 6-8
- +
 - definition, 6-2
- ++++
 - definition, 6-2
- µL
 - definition, ABBREVIATIONS-1

A

- abbreviations
 - list of, ABBREVIATIONS-1
- A^C•T 5diff Cal Calibrator. *See* calibrators
- A^C•T 5diff Control. *See* cell controls
- A^C•T 5diff Diluent
 - See* diluent reagent
 - See* reagents
- A^C•T 5diff Fix
 - See* Fix reagent, 1-7
 - See* reagents
- A^C•T 5diff Hgb Lyse
 - See* Hgb Lyse reagent
 - See* reagents
- A^C•T 5diff Rinse
 - See* reagents
 - See* Rinse reagent
- A^C•T 5diff WBC Lyse
 - See* reagents
 - See* WBC Lyse reagent
- accuracy
 - definition, GLOSSARY-1
 - performance characteristics, 3-8
 - performance specifications, 3-5
- ACD
 - definition, ABBREVIATIONS-1
- action log, B-2
- action ranges
 - default, CBC, A-9
 - default, DIFF, A-11
 - description, A-13
- agglutination
 - definition, GLOSSARY-1
- altitude range, 3-2

- Anemia*, triggering condition, 6-13
- Anisocytosis*, triggering condition, 6-13
- ANSI
 - definition, ABBREVIATIONS-1
- anticoagulant
 - recommended, 3-2
- aperture
 - DIFF, diameter, 3-4
 - RBC, diameter, 3-4
 - WBC/BA, diameter, 3-4
 - See also* blocked apertures
- aspirate probe
 - function, 1-2
 - location illustration, 1-2
- aspirate switch
 - function, 1-2
 - location illustration, 1-2
- ASTM
 - definition, ABBREVIATIONS-1
- AT LEAST 3 TAGGED RESULTS REQUIRED, 8-34
- ATL
 - display/print setup, A-28
- attention
 - definition, 4-1
- Atypical Lymphocyte*, triggering condition, 6-13
- auto-clean
 - frequency, 8-4
 - frequency setting procedure, A-31
 - when performed, 5-11

B

- BA
 - interfering substances, 3-11
- backflush
 - function, 8-12
 - procedure, 8-12
- background count
 - definition, GLOSSARY-1
 - limits, 5-3, 5-4
- band cells
 - description, 2-20
- barcode labels
 - default settings, F-2
 - specifications, F-1
 - symbolologies, list of, F-1
- barcode reader
 - connector location, 1-4
 - entering sample ID, 5-13
- barcode, definition, F-1

- basophil. *See* BA
 - Basophilia*, triggering condition, 6-13
 - BATH ENCLOSURE DOOR OPENED*, 8-34
 - baths
 - cleaning (bleaching) procedure, 8-2
 - draining procedure, 8-14
 - location illustration, 8-11
 - rinsing procedure, 8-13
 - blank cycle
 - definition, GLOSSARY-1
 - blast cells
 - description, 2-20
 - Blasts*, triggering condition, 6-13
 - bleaching. *See* cleaning procedures
 - blocked apertures
 - removing blockage, 8-12
 - bps
 - definition, ABBREVIATIONS-1
- C**
- calibration
 - auto-calibration, 7-3
 - definition, GLOSSARY-1
 - forced (required), 7-9
 - manual, 7-11, C-1
 - number of runs, 7-8
 - passing requirements, 7-9
 - pre-calibration checks, 7-1
 - printing calibration factors, 7-14
 - report example, 7-14
 - requirements, 7-1
 - running, 7-5
 - setup procedures, 7-3, A-23
 - verification out of limit, what to do it, 8-36
 - calibration factors
 - definition, GLOSSARY-1
 - calibrator
 - definition, GLOSSARY-1
 - recommended, 3-2
 - calibrators
 - recommended, 1-7
 - carryover
 - definition, GLOSSARY-1
 - performance characteristics, 3-8
 - performance specifications, 3-6
 - caution
 - definition, 4-1
 - caution labels. *See* labels
 - CBC
 - definition, ABBREVIATIONS-1
 - CBC parameters
 - excessive flagging, what to do if, 8-13
 - CBC/DIFF
 - mode button, 1-3
 - CBC/DIFF parameters
 - excessive flagging, what to do if, 8-13
 - cell control
 - definition, GLOSSARY-1
 - recommended, 1-7
 - results not acceptable, 5-7
 - characteristics
 - definition, GLOSSARY-1
 - See also* performance characteristics
 - cleaning procedures
 - auto-clean, 8-4
 - extended cleaning, 8-2
 - for inside of instrument, 8-2
 - for outside of instrument, 8-2
 - system cleaning, 8-5
 - cm definition, ABBREVIATIONS-1
 - coefficient of variation (CV)
 - definition, GLOSSARY-1
 - Cold agglutinin*, triggering condition, 6-13
 - components
 - resetting to "home" position, 8-15
 - configuration report, printing, A-22
 - contamination
 - risk, 8-4
 - control
 - definition, GLOSSARY-1
 - recommended, 3-2
 - control panel
 - definition of each button, 1-3
 - function, 1-2
 - location illustration, 1-2
 - conventions
 - definition, GLOSSARY-1
 - used in this manual, xix
 - counting assembly
 - function, 8-10
 - location, 8-10
 - counting syringe
 - function, 8-11
 - location, 8-11
 - cursor
 - arrows, 1-11
 - how to move, 1-11
 - cursor keys

- button location, 1-3
- function, 1-3
- CV
 - definition, GLOSSARY-1
- CV% limits
 - changing, A-23
 - defaults, A-23
- cycle count
 - description, A-34
 - viewing, A-34
- D**
- DATA NOT SAVED, VALUE OUT OF RANGE*, 8-34
- date
 - changing, A-5
 - format, selecting, A-4
 - setup procedure, A-4
- debris
 - description, 2-19
- default
 - configuration, instrument, A-1
 - definition, GLOSSARY-1
- delete
 - button location, 1-3
 - function, 1-3
- DIFF syringe
 - function, 8-11
 - location, 8-11
- Diluent reagent
 - description, 1-8
 - input connector location, 1-4
 - replacement procedure, 8-17
- diluent reservoir
 - draining procedure, 8-14
- diluent tank
 - function, 8-10
 - location, 8-10
- diluter system
 - troubleshooting procedures, 8-12
- dilution
 - ratios, 3-2
 - summary, 2-13
- dL
 - definition, ABBREVIATIONS-1
- DRAIN TIMEOUT*, 8-34
- drainage syringe
 - function, 8-10
 - location, 8-10
- draining procedures
 - baths, 8-14
 - diluent reservoir, 8-14
- E**
- EDTA
 - definition, ABBREVIATIONS-1
- enter
 - button location, 1-3
 - function, 1-3
- ENTER AN IDENTIFICATION*, 8-34
- environmental protection requirements, 3-4
- EO
 - description, 2-19
 - interfering substances, 3-11
- eosinophil. *See* EO
- Eosinophilia*, triggering condition, 6-13
- error messages
 - definition, 8-34
 - list, 8-34
 - See also* individual messages
- Erythrocytosis*, triggering condition, 6-14
- escape
 - button location, 1-3
 - function, 1-3
- expiration date
 - definition, GLOSSARY-1
- F**
- femtoliter
 - definition, GLOSSARY-1
- field
 - definition, GLOSSARY-1
- fields
 - how to de-select, 1-12
 - how to select, 1-12
- Fix reagent
 - description, 1-8
 - replacement procedure, 8-21
- fL
 - definition, GLOSSARY-1
- flags
 - *, definition, 6-3
 - *WBC, defined, 6-8
 - ++++, definition, 6-2
 - +, definition, 6-2
 - action range, 6-12
 - ATL, definition, 6-3, 6-7, 6-11
 - BASO+, definition, 6-8

CBC histogram, 6-8
 DB, definition, 6-3, 6-4, 6-11
 definition, 6-1, GLOSSARY-1
 DIFF+, definition, 6-3
 DIFF, definition, 6-11
 DIFF-, definition, 6-3
 DiffPlot, 6-3
 format types, 6-1
 H, definition, 6-12
 HH, definition, 6-12
 HISTO, definition, 6-11
 IMM, definition, 6-3, 6-7, 6-11
 L, definition, 6-12
 LL, definition, 6-12
 LN, definition, 6-3, 6-6
 MACRO, definition, 6-9
 MB, definition, 6-8
 MIC, definition, 6-10
 MICRO, definition, 6-9
 MN, definition, 6-3, 6-5
 NE, definition, 6-3, 6-7
 NL, definition, 6-3, 6-5
 patient range, 6-12
 R, definition, 6-2
 reject, 6-3
 review, definition, 6-2
 SCL, definition, 6-11
 SL, definition, 6-3, 6-4
 SL1, definition, 6-3, 6-5
 types, 6-1
 UM, definition, 6-3, 6-6
 UN, definition, 6-3, 6-6
 V, definition, 6-3
 voteout, definition, 6-3
 WBC/BA, definition, 6-11
 flowcell
 rinsing procedure, 8-13
 flowcell lamp
 replacement, 8-29

G

g
 definition, ABBREVIATIONS-1
 gal
 definition, ABBREVIATIONS-1
 GR
 definition, ABBREVIATIONS-1
 grounding requirements, 3-1

H

H flag
 definition, 6-12
 hardware reset
 function, 8-15
 procedure, 8-15
 hardware system
 troubleshooting, 8-15
 hazards, operational
 list, 4-2
 Hct
 definition, ABBREVIATIONS-1
 interfering substances, 3-10
 header
 report, A-21
 Hgb
 definition, ABBREVIATIONS-1
 interfering substances, 3-9
 Hgb Lyse reagent
 description, 1-8
 replacement procedure, 8-21
 HH flag
 definition, 6-12
 host
 RS 232 connector location, 1-4
Hypochroma, triggering condition, 6-13
 Hz
 definition, ABBREVIATIONS-1

I

IMM
 description, 2-20
 display/print setup, A-28
 immature granulocytes. *See* IMM
 important
 definition, 4-1
INCORRECT DATE ENTRY, 8-34
INCORRECT TIME ENTRY, 8-34
 installation
 by Beckman Coulter representative, A-1
 instrument
 component locations, 8-10
 default configuration, A-1
 dimensions, 3-1
 features, 1-6
 illustration, 1-1
 intended use, 1-1
 limitations, 3-8

- purpose, 1-1
- reported parameters, 1-1
- setup changes, what to do after, A-2
- weight, 3-1
- where to place it, 3-2
- interpretive messages
 - definition, 6-12
 - triggering conditions, 6-13

L

L

- definition, ABBREVIATIONS-1

L flag

- definition, 6-12

labels

- serial number location, 1-4
- warning and caution location, 1-4

laboratory limits

- description, A-8
- setup procedure, A-8

lamp. *See* flowcell lamp

language

- selecting display language, A-2

Large immature cell, triggering condition, 6-13

LCD

- definition, 1-2, ABBREVIATIONS-1
- location illustration, 1-2

LED

- definition, 1-2, ABBREVIATIONS-1
- green, function, 1-2
- green, location illustration, 1-2
- red, function, 1-2
- red, location illustration, 1-2

Left Shift, triggering condition, 6-13

Leukocytosis, triggering condition, 6-13

Leukopenia, triggering condition, 6-13

limits

- background count, 5-3, 5-4

linearity

- definition, GLOSSARY-1
- performance specifications, 3-5

LL flag

- definition, 6-12

log sheets, B-1

- action, B-2
- maintenance, B-3
- reagent, B-4

lot number

- definition, GLOSSARY-1

LY

- description, 2-19
- interfering substances, 3-11

lymphocytes. *See* LY

Lymphocytosis, triggering condition, 6-13

Lymphopenia, triggering condition, 6-13

M

m

- definition, ABBREVIATIONS-1

MACRO flag

- definition, 6-9

Macrocyte, triggering condition, 6-14

Macrocytosis, triggering condition, 6-14

Macroplatelets, triggering condition, 6-14

maintenance

- log sheet, B-3
- schedule, 8-1

material safety data sheet. *See* MSDS

MB flag

- definition, 6-8

MCH

- interfering substances, 3-10

MCHC

- interfering substances, 3-10

MCV

- interfering substances, 3-10

mean

- definition, GLOSSARY-1

menu

- selecting menu items, 1-11

messages. *See* interpretive messages

MIC flag

- definition, 6-10

MICRO flag

- definition, 6-9

Microcyte, triggering condition, 6-14

Microcytosis, triggering condition, 6-13, 6-14

mL

- definition, ABBREVIATIONS-1

mm

- definition, ABBREVIATIONS-1

MO

- description, 2-19
- interfering substances, 3-11

monocyte. *See* MO

Monocytosis, triggering condition, 6-13

motherboard

- function, 8-12

- location, 8-12
- screws securing in place, 8-12
- motors, checking, 8-15
- MPV
 - interfering substances, 3-11
- MSDS
 - definition, ABBREVIATIONS-1
 - how to order, 1-13
- mW
 - definition, ABBREVIATIONS-1
- Myelemia*, triggering condition, 6-13

N

- n
 - definition, ABBREVIATIONS-1
- NCCLS
 - definition, ABBREVIATIONS-2
- NE
 - description, 2-19
 - interfering substances, 3-11
- Neutropenia*, triggering condition, 6-13
- neutrophil. *See* NE
- Neutrophilia*, triggering condition, 6-13
- nm
 - definition, ABBREVIATIONS-2
- NO ACK CHARACTER RECEIVED ON RS232*, 8-34
- NO DILUENT, CHECK LEVEL*, 8-34
- NO ENQ CHARACTER RECEIVED ON RS232*, 8-34
- Nucleated RBC*, triggering condition, 6-15
- numeric keypad
 - button location, 1-3
 - function, 1-3

O

- ON/OFF switch
 - location, 1-2
- operating range
 - definition, GLOSSARY-1
- operator ID
 - defining, A-25
- optical bench
 - function, 8-11
 - location, 8-11

P

- Pancytopenia*, triggering condition, 6-14
- parameters

- analyzed, CBC parameters, 1-5
- analyzed, CBC/DIFF parameters, 1-6
- definition, GLOSSARY-1
- password
 - changing, A-3
 - default, A-3
- patient ranges
 - default, CBC, A-9
 - default, DIFF, A-11
 - description, A-8
- performance characteristics
 - accuracy, 3-8
 - carryover, 3-8
 - definition, GLOSSARY-1
 - reproducibility, 3-7
- performance specifications
 - accuracy, 3-5
 - carryover, 3-6
 - definition, GLOSSARY-2
 - linearity, 3-5
 - reproducibility, 3-5
- pg
 - definition, ABBREVIATIONS-2
- Plt
 - interfering substances, 3-10
- Plt aggregate*, triggering condition, 6-15
- power
 - consumption, 3-1
 - power supply, 3-1
 - will not turn on, what to do if, 8-36
- power supply
 - cord connector location, 1-4
- precision
 - definition, GLOSSARY-2
 - poor, what to do if, 8-37
- priming reagents
 - procedure, 8-26
 - when to do, 8-26
- print
 - button, 1-3
 - function, 1-3
- printer
 - configuration procedure, A-20
 - connector location, 1-4
 - daily printer check, 5-1
 - prints incorrectly, what to do if, 8-37
 - required model, 1-10
 - settings, A-18
- PRINTER ERROR, CHECK PAPER*, 8-34

Q

quality control (QC)
definition, GLOSSARY-2

R

R flag
description, 6-3

range
association, 1-10
button location, 1-3
description, 1-10
function, 1-3
reportable, 3-6

RBC
interfering substances, 3-9
stable RBCs and unstable Plts, what to do if, 8-37

RDW
interfering substances, 3-10

reagent log
sample, B-4

REAGENT LOW LEVEL, 8-17, 8-21, 8-34, A-32

REAGENT LOW LEVEL (REAGENT NAME), 8-34

REAGENT LOW LEVEL (X), A-32

reagent syringe
function, 8-11
location, 8-11

reagents
consumption by cycle, 3-4
location, 8-16
priming procedure, 8-26
recommended, 1-7, 3-2
replacement procedures, 8-15
volume setup procedure, A-33
volumes, default, A-33
when to replace, 8-21

replacing the waste container, 8-27

report
system setup, A-22
See also sample report

reportable range
Hct, 3-6
Hgb, 3-6
Plt, 3-6
RBC, 3-6
WBC, 3-6

reporting units
formats available, A-7
selection procedure, A-7

reproducibility
definition, GLOSSARY-2
performance characteristics, 3-7
performance specifications, 3-5
poor, what to do if, 8-37

results
exceeding instrument capacity, 6-2

review flag
description, 6-3

Rinse reagent
description, 1-8
replacement procedure, 8-21

rinsing procedures
baths, 8-13
flowcell, 8-13

S

safety precautions
biological, 8-4
list of, 4-1
while performing maintenance or service, 8-4

sample analysis
after, what to do, 5-10
before, what to do, 5-1
procedure, 5-8

sample ID
available methods, 5-11
entering, A-27
mode selection, A-27
scanning with barcode reader, 5-13

sample identification
See sample ID

sample probe
malfunctioning, 8-36

sample report
header, A-21
printout example, A-19

samples
entering IDs, 3-3
number processed per hour, 3-3
presenting to the sample probe, 1-13
stability of, 3-3

sampling syringe
function, 8-10
location, 8-10

sampling traverse
function, 8-10
location, 8-10

Schistocyte, triggering condition, 6-14

SCL flag
 definition, 6-11

SD (standard deviation)
 definition, GLOSSARY-2

serial number
 label location, 1-4

Shutdown
 button, 1-3
 cycle definition, GLOSSARY-2
 function, 1-3
 procedure, 5-11

SI 1. *See* reporting units
 SI 2. *See* reporting units
 SI 3. *See* reporting units
 SI 4. *See* reporting units

Small cell, triggering condition, 6-14

software cursor. *See* cursor

software fields. *See* fields

software menu. *See* menu

specifications
See performance specifications

specimen
 collection requirements, 5-5
 limitations, 3-8
 mixing requirements, 5-5

Startup
 button, 1-3
 failure, 8-36
 function, 1-3
 when to do, 5-2

startup cycle
 definition, GLOSSARY-2

symbols
 safety, xx
 tab, xx

system cleaning
 procedure, 8-5
 when to do, 8-5

SYSTEM ERROR, RUN SYSTEM RESET CYCLE,
 8-35

system reset cycle
 description, 8-9
 when required, 8-9

system setup report, printing, A-22

T

TABLE OF EXPECTED RESULTS
 definition, GLOSSARY-2

tabs

manual dividers, xx

temperature
 ambient operating range, 3-1
 instrument, not achieved, 8-36

TEMPERATURE OUT OF RANGE, 8-35

*THE PRINTER IS DISCONNECTED, SWITCHED
 OFF, OR HAS NOT BEEN SELECTED*, 8-35

thresholds
 description, 2-4

Thrombocytopenia, triggering condition, 6-14

Thrombocytosis, triggering condition, 6-14

time
 changing, A-5
 format, selecting, A-5

TIMEOUT OVERFLOW ON RS232, 8-35

training checklist, E-1

troubleshooting
 dilution problems, 8-36
 electrical problems, 8-37
 flowchart, D-1
 guide, 8-36
 mechanical problems, 8-37
 optical problems, 8-37
 pneumatic problems, 8-37
 power problems, 8-36
 printer problems, 8-37
 procedures, 8-12
 reagent problems, 8-37
 results problems, 8-37
 sampling problems, 8-36
 Startup problems, 8-36

U

U.S. *See* reporting units

USER PASSWORD, 8-35

V

Vac
 definition, ABBREVIATIONS-2

valves, checking, 8-15

Vds
 definition, ABBREVIATIONS-2

verification
 definition, GLOSSARY-2

W

warning

- definition, 4-1, 8-4
- warning labels. *See* labels
- waste
 - output connector location, 1-4
- waste container
 - replacement, 8-27
 - waste sensor, 8-27
- waste sensor
 - function, 8-27
 - location, 8-27
- WBC
 - definition, ABBREVIATIONS-2
 - interfering substances, 3-9
- WBC Lyse reagent
 - description, 1-8
 - replacement procedure, 8-21
- whole blood
 - definition, GLOSSARY-2
- workload, daily
 - changing, A-32
 - defaults, A-32
 - description, A-32
- WRITE ERROR RS232, 8-35

X

- XXX NOT REACHING HOME, 8-35

AC•T and Beckman Coulter are trademarks of Beckman Coulter, Inc.

All other trademarks, service marks, products, or services are trademarks or registered trademarks of their respective holders.

BECKMAN COULTER™ AC•T 5diff Hematology Analyzer Documentation

- **Operator's Guide**
PN 4237615
Use and Function • Operation Principles • Specifications/Characteristics • Precautions/Hazards • Running Samples • Reviewing Results • Calibration • Diagnostics • Instrument Setup • Log Sheets • Manual Calibration • Troubleshooting Flowchart • Training Checklist • References • Glossary • Abbreviations • Index
- **Host Transmission Specification**
PN 4277065
Defines requirements for interfacing the instrument to a host computer.

Come visit us at www.beckmancoulter.com



Copyright © Beckman Coulter, Inc. 2000
All Rights Reserved
Printed on Recycled Paper



COULTER CORPORATION
A Beckman Coulter Company
Miami, Florida 33196-2500 USA