

# Operating Manual

## for the

## Autoclave

# Euroklav<sup>®</sup> 29V -S

---

Dear Doctor:

Thank you very much for the trust which you have shown by purchasing this autoclave.

For nearly 50 years now, MELAG — a medium-sized family-owned and -operated company — has specialized in the production of sterilization equipment for medical practice. During this period, MELAG has succeeded in becoming a leading manufacturer of sterilization equipment. More than 300 000 MELAG units sold throughout the world testify to the exceptional quality of our sterilizers. — which are manufactured exclusively in Germany.

As all other MELAG products, this autoclave was manufactured and tested according to strict quality criteria. Before placing this unit into operation, please read this Operating Manual carefully. The long-term functional effectiveness and the preservation of the value of your autoclave will depend on careful preparation of instruments before sterilization, and on proper care of the unit.

The staff and management of MELAG

---

**To ensure the functional effectiveness of this unit and to preserve its value:**

1. Prepare the instruments to be sterilized carefully
2. Take proper care of the autoclave
3. Use only pure distilled or demineralized water

## CONTENTS

<b>1 DESCRIPTION OF THE UNIT</b> .....	<b>3</b>
1.1 Views of the unit.....	3
1.2 Control panel.....	5
1.3 Technical data.....	5
1.4 Performance features of this autoclave .....	5
1.4.1 Prevacuum procedure combined with pulsed flow method.....	5
1.4.2 Operating range for sterilization .....	5
1.4.3 Integrated steam generation.....	5
1.4.4 One-way/Closed-loop system/ Conductivity measurement/ Automatic water refilling .....	5
1.4.5 Electronic Parameter Control EPS .....	6
1.4.6 Combined pressure pulsing and vacuum drying .....	6
1.4.7 Pre-heating .....	6
1.4.8 Documentation .....	6
<b>2 INSTALLATION</b> .....	<b>6</b>
2.1 Setting up the autoclave .....	6
2.2 Transport ribbons.....	6
2.3 Levelling.....	7
2.4 Mains power supply .....	8
2.5 Outlet connection for one-way water .....	8
2.6 Internal water supply with demineralized/distilled water.....	8
2.7 Connection of a water purification system .....	8
<b>3 INITIAL START-UP</b> .....	<b>8</b>
3.1 Printer connection/ Initialization (optional).....	8
3.1.1 Connecting the MELAprint® 42.....	8
3.1.2 Initialization of the printer / Setting up immediate print-out .....	8
3.2 Vacuum test.....	9
3.3 Test run.....	10
3.4 Installation record.....	10
3.5 Safety instructions.....	10
<b>4 INSTRUCTIONS FOR ALL STERILIZATION PROCEDURES</b> .....	<b>11</b>
4.1 Electricity and water supplies .....	11
4.1.1 Distilled or demineralized feed water .....	11
4.1.2 Power supply .....	11
4.2 Preparing instruments for sterilization .....	11
4.3 Loading the autoclave.....	12
4.4 Closing the door.....	13
4.5 Program selection.....	13
4.6 Program start .....	14
4.7 Program progress .....	14
4.8 Print-out record .....	16
4.9 Removing the sterilized items.....	17
4.10 Sterile storage.....	17
4.11 Sterilization frequency / pauses.....	17
4.12 Manual termination of program.....	18
4.12.1 Termination of sterilization.....	18
4.12.2 Terminate drying.....	19
4.13 Reaction to warnings / error messages .....	20
4.14 Operational pauses.....	20
<b>5 CLOSING DOWN / TRANSPORT / REINSTALLATION</b> .....	<b>20</b>

<b>6</b>	<b>SPECIAL FUNCTIONS</b>	<b>21</b>
6.1	Water quality (conductivity)/ Chamber preheating temperature	21
6.2	Selecting extra drying	21
6.3	Records / Load documentation	21
6.3.1	Record print-out	22
6.3.1.1	External printer	22
6.3.1.1.1	Connecting the external MELAprint®42	22
6.3.1.1.2	Initializing the printer	22
6.3.1.2	Connection to an external PC	23
6.3.1.2.1	Installation	23
6.3.1.2.2	Downloading to a PC	23
6.3.1.3	No printer	23
6.3.2	Immed. print-out? Yes/No	23
6.3.3	Printing out stored records	24
6.3.4	Print all stored cycle records	25
6.3.5	Display printer memory status	26
6.3.6	Deleting cycle records	27
6.3.7	Test print-out	28
6.4	Resetting date and time	29
6.5	Automatic preheating	30
6.6	Total load count	31
6.7	Distilled / demineralized water supply	32
6.8	Water system	33
6.9	Program modifications	33
<b>7</b>	<b>OPERATIONAL ERRORS / MALFUNCTIONS</b>	<b>34</b>
7.1	What to do if the autoclave malfunctions	34
7.2	Malfunctions without display messages	34
7.2.1	No display	34
7.2.2	Excessive water consumption	34
7.2.3	Poor drying	34
7.3	Warning messages	35
7.4	Error reports	38
<b>8</b>	<b>TAKING CARE OF YOUR AUTOCLAVE</b>	<b>41</b>
8.1	Preparation of instruments	41
8.2	Rust formation = Drag-in rust	41
8.3	Taking care of the Euroklav®29V-S	42
8.3.1	Cleaning	42
8.3.2	Use of demineralized or distilled water	42
8.4	Checking the operation of the autoclave	43
8.4.1	Safety with automatic monitoring	43
8.4.2	Periodical bacteriological testing (twice a year)	43
8.4.3	Maintenance recommendations	43
<b>9</b>	<b>ANNEX</b>	<b>44</b>
9.1	Installation options	44
9.2	Additional technical data	45
9.2.1	Capacity/Weight	45
9.2.2	External supplies	45
9.2.3	Operational parameters	45
9.3	Instructions on drying	46
9.3.1	Drying in sterilization containers	46
9.3.2	Textiles	47
9.3.3	Instruments	48
9.3.4	Loading the autoclave	48
9.3.5	Loading containers with soft sterilization packing material	48
9.3.6	Stacking sterilization containers	49
9.3.7	Removing the sterilized items	49
9.3.8	Improving the drying	49

## **1 Description of the unit**

### **1.1 Views of the unit**

Fig. 1 Views of the Euroklav®29V-S

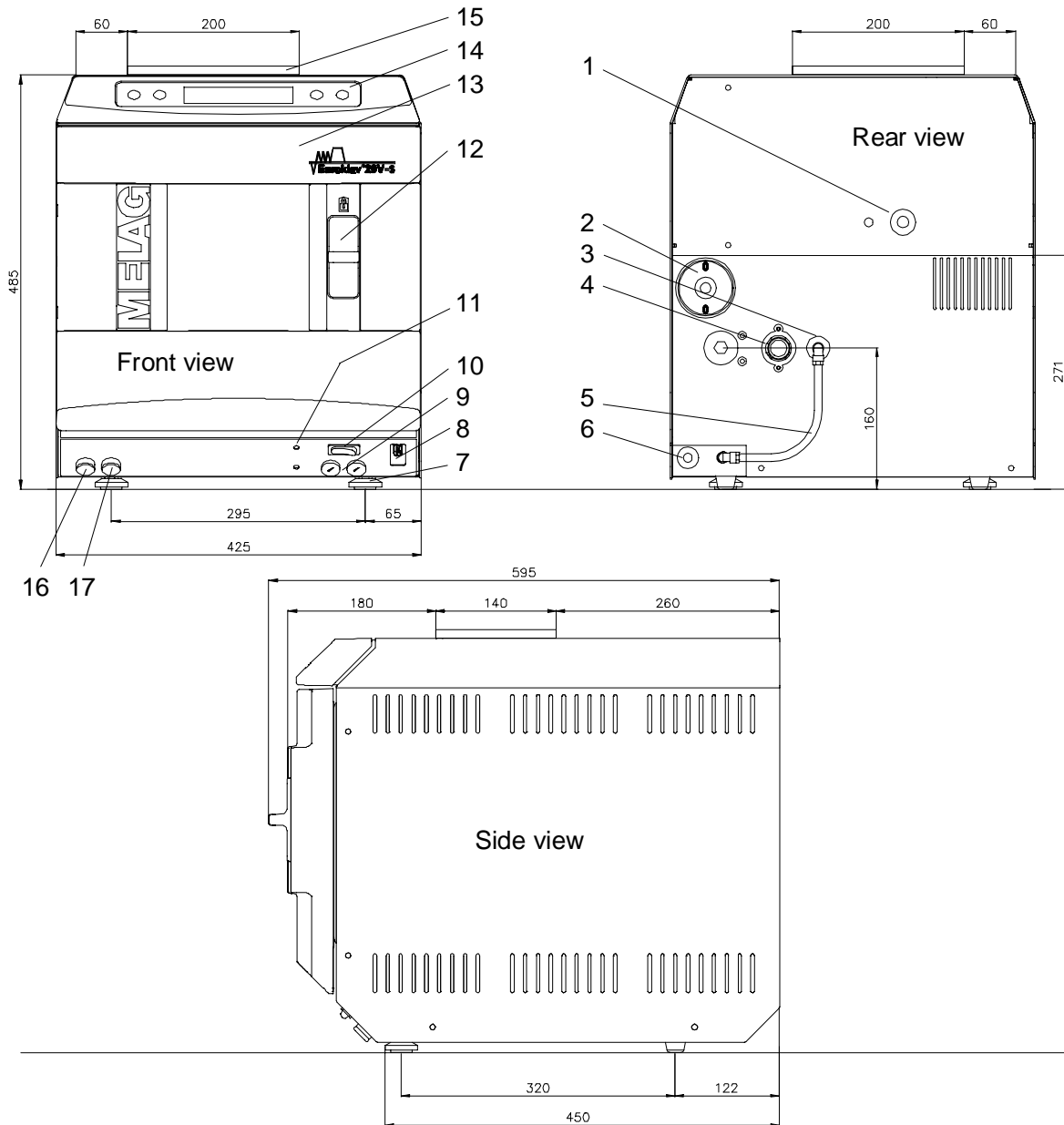

- |   |   |    |  |
|---|---|----|--|
| 1 | Safety valve I  | 9  | Fuses - 2 x 16 A / FF                      |
| 2 | Sterile filter  | 10 | Power switch                               |
| 3 | Connection for internal distilled / demineralized water supply      | 11 | Overheating trip-switch, steam generator   |
| 4 | One-way water outlet (3/4")   | 12 | Sliding door lock                          |
| 5 | Pipe connection for internal demineralized / distilled water supply | 13 | Door (left side hinge)                     |
| 6 | Mains power cable   | 14 | Control panel                              |
| 7 | Adjustable front feet   | 15 | Tank lid                                   |
| 8 | Serial data and printer port ( RS 232 )                             | 16 | Outlet connection for wastewater           |
|   |   | 17 | Outlet for distilled / demineralized water |

## 1.2 Control panel

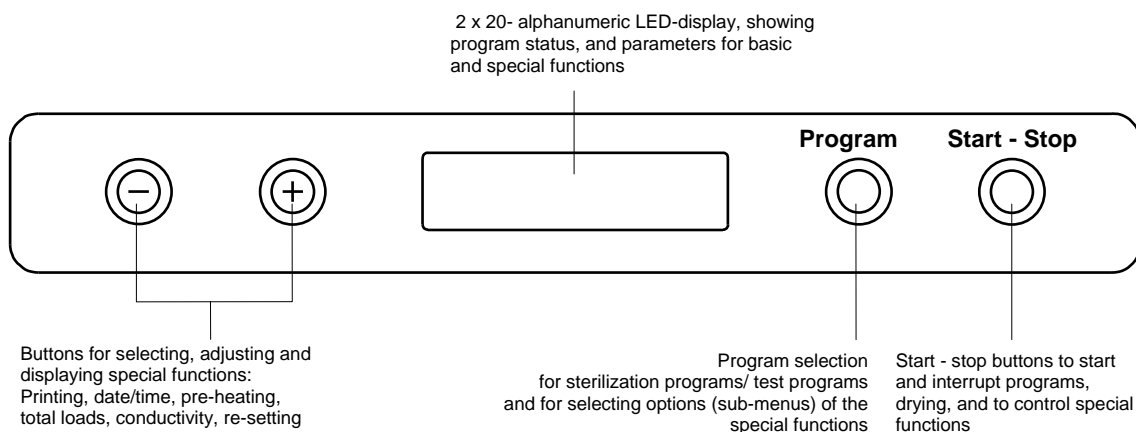

Fig. 2 Control panel Euroklav®29V-S

## 1.3 Technical data

Sterilization space (diameter x depth )	:	25cm x 36cm
Electric power supply	:	2400W / 230V AC / 10.4 A / 50....60Hz
Sterilization pressure / temperature	:	2bar/134°C; 1bar/121°C
Maximum load:	:	3kg instruments or 0.9kg textiles

Further technical details are included in the Annex

## 1.4 Performance features of this autoclave

### 1.4.1 Prevacuum procedure combined with pulsed flow method

With the pre-vacuum procedure, most of the air is evacuated from the sterilization chamber and the load in a first step.

Then the pulsed flow method is used in which steam flows into and then out of the autoclave to ensure effective penetration of the items to be sterilized by superheated steam.

This makes it possible to carry out demanding sterilization tasks rapidly and reliably, such as for example the sterilization of wrapped instruments or textiles.

The steam penetration can be tested by implementing a special test program for the Bowie & Dick Test, which is the standard test for large-scale sterilization. operations..

### 1.4.2 Operating range for sterilization

The Euroklav®29V-S has two sterilization programs at 134°C: for wrapped loads the "Universal program", and for unwrapped loads the "Quick program", and an additional sterilization program for textiles and rubber articles at 121°C, the "Gentle program". The test program for steam penetration ("Bowie & Dick Test") and a test program for leaks ("Vacuum Test") allow the operator to check the operation of the autoclave at any time.

### 1.4.3 Integrated steam generation

The powerful steam generation in the sterilization chamber makes it possible to sterilize large loads of instruments or textiles in a short time. This system of steam generation means that excess temperatures in the sterilized chamber are not possible.

### 1.4.4 One-way/Closed-loop system/ Conductivity measurement/ Automatic water refilling

The Euroklav®29V-S can be operated in the tried and tested one-way system, in which steam, condensed water and all dissolved impurities are led away at the end of every sterilization cycle, and fresh demineralized or distilled water is then used. This is particularly good for all the materials used. However, in some instances it is also important to use less water, and the Euroklav®29V-S can also be used in a water-conserving closed-loop mode. In this case the used water flows from the left side of the double-chamber storage container over the separating wall into the right-hand chamber. This water is then used again in the next sterilization cycle. With the closed-loop operation it is important that the instruments to be sterilized have been very carefully washed and swilled in purified water. The water in the autoclave must also be exchanged once a week.

An integrated electrical conductivity meter monitors the quality of the demineralized or distilled water used to generate the steam. Using the recommended one-way operation for the autoclave, the increased consumption of demineralized or distilled water can be provided by a water purifier such as the MELAdem®47 or MELAdem®37, which can be directly connected to the autoclave.

Provided that the instruments are prepared carefully for the sterilization, stains on the load and soiling of the autoclave itself can be prevented.

## 1.4.5 Electronic Parameter Control EPS

---

The microprocessor in the Euroklav<sup>®</sup>29V-S makes it possible to monitor pressure, temperature and time continuously during a program by Electronic Parameter Control. The overall operating time can then be optimised according to the load and the temperature of the autoclave.

The process assessment and monitoring system in the program control compares current process parameters with standard process data and monitors the process relative to limit values for temperatures, times and pressures. This makes it possible to identify faults as they occur, and provides quality assurance for the sterilization process.

## 1.4.6 Combined pressure pulsing and vacuum drying

---

This method ensures good drying results even for wrapped instruments.

## 1.4.7 Pre-heating

---

By activating the "pre-heating" function, the cold autoclave chamber can be warmed up before sterilization, or the temperature can be maintained between sterilization runs. This reduces the duration of cycles and considerably reduces the formation of condensation, thus improving drying results.

## 1.4.8 Documentation

---

The electronic memory stores records of the previous 40 programs.

For effective hard-copy documentation and for checking purposes a MELAprint<sup>®</sup>42 printer can be connected to print out a record immediately after completion of a program or to print out records from the memory.

## 2 Installation

---

When setting-up and installing the autoclave, please consult the separate instruction leaflet "Installing the Euroklav<sup>®</sup> 29V-S".

### 2.1 Setting up the autoclave

---

The autoclave should be set up in a dry place which is protected against dust. The base should be stable, and able to support the weight of the appliance (unloaded weight 43 kg). The space required by the autoclave can be seen from the external dimensions (as in Section 1.1). A minimum additional space of 10 cm should be allowed on either side and above the autoclave in order to ensure that heat can escape.

The electrical power supply should be a separate 230V AC circuit with a 16 A fuse.

Should it be decided at some stage to install an automatic one-way water system, it is necessary to have a connection to the wastewater plumbing near the autoclave, preferably a wall outlet (NW 40) or a sink-trap (standard length of outflow pipe 2m, 16 mm width). The work surface on which the autoclave stands must be higher than the outlet, and the outlet pipe must be without bends and twists which could prevent water flowing out freely. At the same time, the work surface must provide convenient access to the autoclave, and the display must be clearly visible.

The autoclave can be supplied with demineralized/distilled water from the integrated two chamber storage tank, with freshwater and wastewater chambers. Alternatively, the Euroklav<sup>®</sup> 29V-S can also be connected to an external water purifier - MELAdem<sup>®</sup>47 or MELAdem<sup>®</sup>37 (or an equivalent water purification system). However, please note that this will require additional space.

### 2.2 Transport ribbons

---

Take the autoclave out of the packaging by means of the transport ribbons. The ribbons themselves are each removed by undoing two retaining screws, which must then be screwed firmly back in place without washers.

## 2.3 Levelling

In order to ensure that condensate can drain out of the autoclave (which is important if it is to operate properly) the appliance must be higher at the front than at the back. The autoclave should first be installed in a horizontal position (this should be checked with a spirit level at the chamber flange) and then the front feet should be extended by giving them three (3) turns.

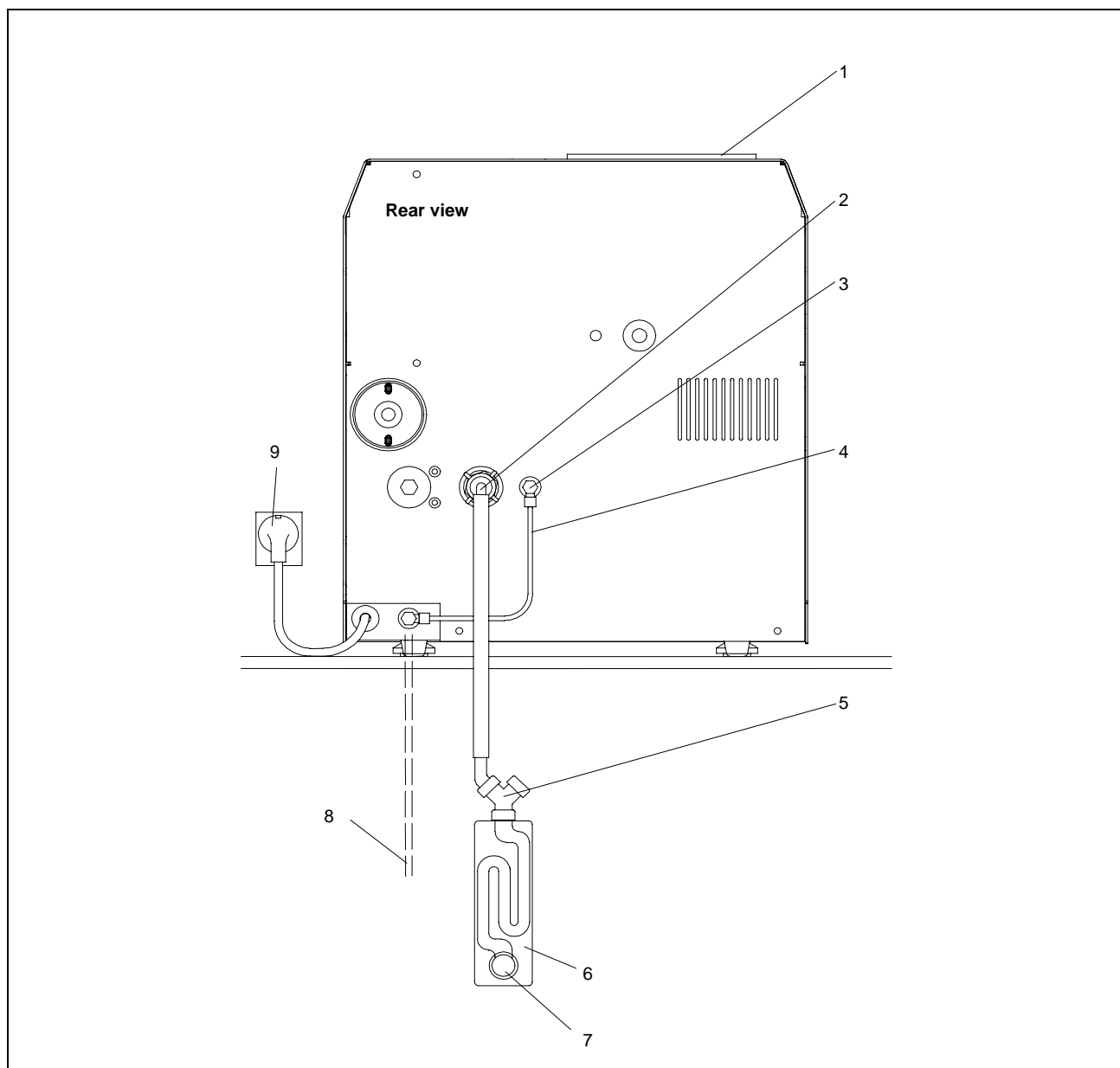

Fig. 3 Installation of the Euroklav®29V-S with wall-mounted trap

- 1 Tank lid
- 2 One-way outlet
- 3 Connection for internal supply of demineralized/distilled water
- 4 Pipe link for internal supply of demineralized/distilled water
- 5 Y-connection with non-return valve (included in Item 6 )
- 6 Wall-mounted trap (MELAG- Art.- No.: 37410)
- 7 Wall outlet (NW 40)
- 8 Supply line for external supply of demineralized/distilled water
- 9 Mains power supply

## 2.4 Mains power supply

---

The electric cable of the appliance is plugged into a mains socket rated at 230 V, 50 Hz. The power rating of the autoclave is 2400 W. In order to avoid overloading the electricity supply, we recommend using a separate electrical circuit fitted with a 16 A fuse and optionally protected with a 30mA circuit breaker.

## 2.5 Outlet connection for one-way water

---

The connection for the one-way water outlet at the back of the appliance is connected to the drainage system of the building by means of the outlet pipe supplied (textile-reinforced transparent pipe, DN16). It is important that the pipe should have a steady downward gradient, without twists and kinks.

When connecting to a separate outflow pipe NW40, a wall-mounted trap should be used (MELAG Art.-No. 37410, see Fig. 3).

## 2.6 Internal water supply with demineralized/distilled water

---

The internal supply of demineralized/distilled water is used for the autoclave in closed-loop operation (see page 44, Fig. 4), the water is extracted from the right chamber of internal water storage tank. The autoclave is supplied with a pipe link with two swivel connections installed to connect the storage tank outlet with the inlet for demineralized/distilled water.

To fill the tank the lid must be removed and the demineralized/distilled water of suitable purity filled into the right-hand chamber until the Max mark.

## 2.7 Connection of a water purification system

---

The autoclave can be connected directly to a water purification unit which provides the demineralized or distilled water required (see page 44, Fig. 4). Instead of connecting the feed water inlet to a storage container, it is simply connected directly to the water purification unit.

The reverse-osmosis systems MELAdem<sup>®</sup>47 and the ion-exchanger MELAdem<sup>®</sup>37 are ideally suited to provide the quantity and quality of water needed for the Euroklav<sup>®</sup>29V-S.

Detailed instructions on the installation of these water purification units are provided in their operating manuals.

When connecting water purification systems from other manufacturers it is very important to ensure that they are able to provide sufficient amounts of water at the required purity. You are generally advised to consult MELAG first.

## 3 Initial start-up

---

### 3.1 Printer connection/ Initialization (optional)

---

#### 3.1.1 Connecting the MELAprint<sup>®</sup>42

---

The autoclave can be connected to an external printer, the MELAprint<sup>®</sup>42. This is not supplied as standard with the autoclave.

In order to connect the printer to the autoclave follow the description in Section 6.3.1.1.1.

#### 3.1.2 Initialization of the printer / Setting up immediate print-out

---







Initialize the external printer (registering with the processing unit of the autoclave) as described in Section 6.3.1.1.2. In order to select the immediate print-out option, which means that a record of each sterilization is printed out automatically as soon as it has finished, proceed as described in Section 6.3.1.3.

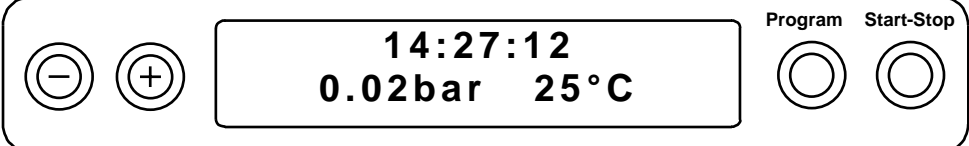

### 3.2 Vacuum test

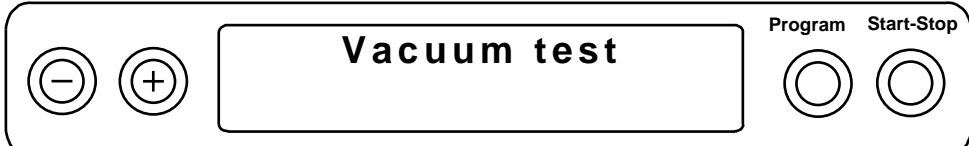
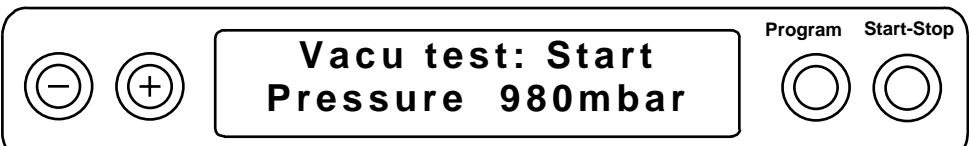
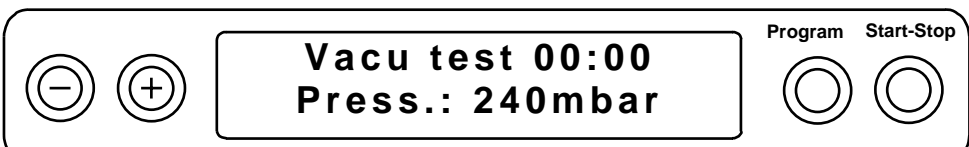
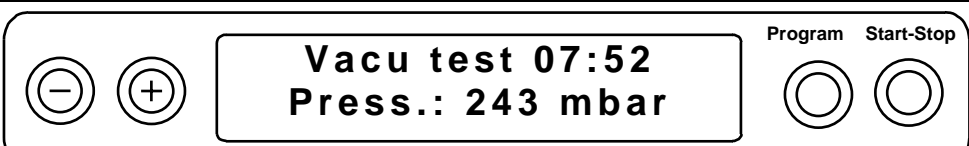
In order to check the operation of the autoclave in the course of the initial start-up, after long periods without being used, or after moves, as well as periodically during routine use, a vacuum test should be carried out to check for leaks.

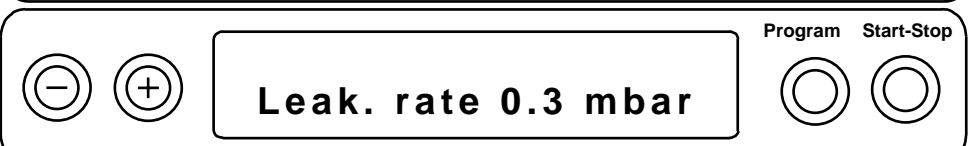
The vacuum test should be carried out as follows, preferably on the cold autoclave:

Operation	Display message
1. Switch on power, then after the message  the display will show the basic parameters	
	
2. Close the door	
3. Press the "Program" button several times until the display shows "Vacuum test"	
4. Press "Start - Stop" button	
5. The evacuation pressure has been reached. The equalisation period begins	
6. After waiting for the equalisation (5 min) the measuring period starts (running here e.g. for 7 min 52s)	
7. After the measuring period (10 min) the chamber is ventilated and  then the leakage rate is displayed (if the immediate printout option is selected for an attached printer then a record will also be printed) After the message "Please wait Door unlocking" this alternating message will appear:	
	
	

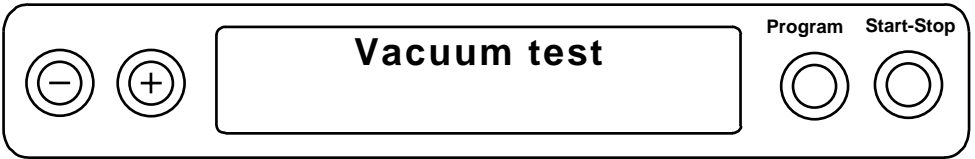
Operation	Display message
8. Open door	

If the leakage rate is above the limit value, then the display (and the print-out) will also show "Test unsuccessful". In this case, follow the instruction in 7.3.

### 3.3 Test run

In order to check the operation of the autoclave under realistic conditions, a test run should be carried out with the "Universal Program, 134°C wrapped" and a relevant load. After loading the autoclave and selecting the program with the "Program" button, sterilization is started by pushing the "Start/Stop" button. If the program runs correctly, the following message will appear on the display (see Section 4.7):

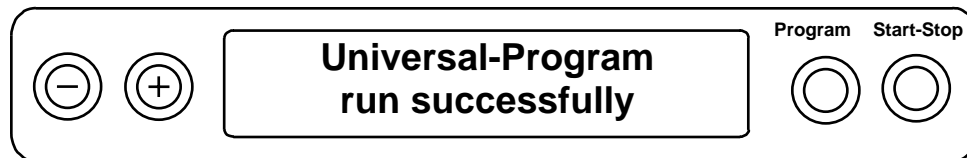

with the values for the maximum values for pressure and temperature. If the immediate printout option has been selected for an external printer a record of the program run will be printed.

### 3.4 Installation record

As documentation that the autoclave has been set-up properly, an installation record should be produced by an authorised person and a copy sent to MELAG. This is important in the event that you wish to make claims under warranty provisions.

### 3.5 Safety instructions

- When opening the door, particularly after interrupting the drying process, residual steam can escape from the autoclave chamber.
- After opening the door, do not touch any metal surfaces - these will be hot! Danger of burns. Always use the tray lifter to remove trays, or wear suitable hand protectors when taking out other items
- If you install the optional water purifier MELAdem<sup>®</sup>47 or MELAdem<sup>®</sup>37 we recommend the installation of a water leak detector (see installation details Section 2).
- If you intend to install a water purification unit from another manufacturer, then consult MELAG before you do so.
- The appliance is not suitable for sterilizing liquids.
- Under current VDE-regulations, this appliances is not suited for use in areas where there are risks of explosion.
- The appliance must only be serviced and repaired by MELAG or by its authorised representatives (specialist dealers or customer services) using only original parts and following service instructions.
- Before opening the housing always disconnect from the mains power supply!
- In order to ensure effective sterilization with the autoclave observe the instructions in this operating manual, and in particular ensure that the loading of the autoclave is appropriate for the program selected.

## 4 Instructions for all sterilization procedures

### 4.1 Electricity and water supplies

#### 4.1.1 Distilled or demineralized feed water

The autoclave automatically monitors the availability of cooling water and purified water, as well as the quality of the distilled / demineralized water before starting a program.

In order to allow an immediate program start and to avoid error reports or interruptions of programs (see Sections: 7.3 and 7.4) :

- Before the first sterilization at the start of the working day, check that the internal water supply has sufficient water in the right chamber of the double internal tank. If necessary, refill with water of appropriate quality (see Section 8.3.2).
- If the feed water is drawn directly from a MELAdem®47 water purifier, check that its water supply is turned on in good time (this may be up to an hour before starting a sterilization program), if the water supply has been turned off over night, for example.

#### 4.1.2 Power supply

Switch on the power using the switch on the front of the autoclave (bottom right). About 15 seconds after the message "Please wait Door release" the appliance is in the start status:

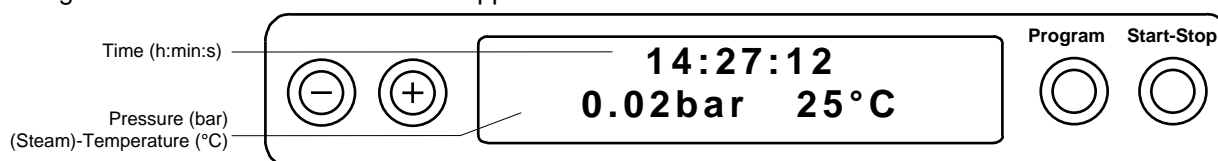

### 4.2 Preparing instruments for sterilization

#### MELAG - rust-free materials

All parts of the Euroklav®29V-S which come into contact with steam are made on non-rusting materials: the pressure chamber and the door of stainless steel, steam pipes of Teflon, and screws and magnet-valves of bronze.

#### Film rust

The use of these materials means that no parts of the autoclave can initiate rust formation. Where rust does attack the autoclave or instruments sterilized in it, tests repeatedly show that this has been brought into the autoclave on instruments (film rust).

Even top-quality stainless steel instruments can form rust if they are not handled properly, e.g. if they are treated with the wrong chemical cleaning or disinfecting agents.

#### Preparing items for sterilization

The example of the formation of film rust shows how important it is to prepare items properly before sterilization.

Handpieces and contra-angles must be cleaned before sterilization and maintained (e.g. by oiling).

Other instruments must be disinfected and cleaned immediately after use in accordance with UVV/VBG 103, or similarly strict national codes of practice in a disinfectant and/or cleaning solution at the correct concentration for the correct length of time

MELAG recommends the use of cleaning aids such as ultrasonic baths, cleaning and maintenance equipment for handpieces for contra-angles, as well as thermo-disinfecting devices.

It is essential that the instruments are well cleaned in order to avoid dirt and contamination being separated from the load in the autoclave and clogging filters, valves, and nozzles. In particular locks, joints, and hinges must be cleaned thoroughly with a brush before sterilization. No traces of cleaning and disinfecting agents should be allowed to enter into the sterilization chamber of the autoclave, since this can give rise to corrosion! The instruments should be swilled off with demineralized water and then dried off before being loaded in the autoclave. Turbines and handpieces must be oiled in accordance with the manufacturer's instructions in order to ensure their long working life.

#### Brand-new instruments

The cleaning procedures described above must also be followed before sterilizing brand-new instruments. These often carry small amounts of grease, oil and soiling from the manufacturing process.

**Important:** Carefully follow all instructions provided by manufacturers of instruments for the preparation of their products for first-time sterilization and for subsequent sterilizations.

## 4.3 Loading the autoclave

---

It is of crucial importance for effective sterilization and good drying that the autoclave is loaded properly: When loading the autoclave, take account of the following points:

### Tray rack

For the Euroklav<sup>®</sup>29V-S there are 2 types of tray rack:

Type "A" (MELAG-Art.-No.: 40231) for up to 6 trays and

Type "B" (MELAG-Art.-No.: 40234) for up to 4 trays or 4 standard tray-cassettes

Both types of tray rack are also suitable for the MELAG-sterilization containers Type 15K,M,G; Type 17 K, Type 17R; Type 23R, Type 28 M, Type 28G).

Normally, the autoclave should be used in conjunction with a tray rack, since this ensures that steam penetration and drying are as good as possible. In exceptional situations (e.g. when using sterilization containers from other manufacturers), and after consultation with your specialist dealer or with MELAG, the tray rack can be removed and the container can be placed directly in the autoclave chamber.

For the sterilization of instruments sealed in transparent sterilization wrapping, it is recommended that you use the foil stand MELAG-Art.-No.: 22410. This contributes considerably to the drying process for such wrapped instruments.

### Trays

Trays for objects which are to be sterilized must be perforated, in order to allow condensation to run away. MELAG-trays are recommended. If you use dishes or trays without perforations, then the objects being sterilized will not dry properly.

### Enclosed sterilization containers

Enclosed sterilization containers must be perforated on at least one side (preferably underneath) or must have valves, in order to ensure that steam can penetrate and condensate can run out. All MELAG-sterilization containers meet these requirements with perforations on two sides and filter-cloth- inlays.

Sterilization containers which only have perforations on the top only allow limited drying.

If sterilization containers are stacked in the autoclave, it is important to ensure that the perforations are not blocked.

### Transparent sterilization packaging

If you use transparent sterilization packaging, such as MELAfo<sup>®</sup>, then the items should if possible be stood vertically on the tray, or sterilized in foil holders (MELAG-Art.-No.: 22410). They should never be laid flat one on top of the other.

If seals split open during sterilization it may be necessary to increase the length of the impulse on the sealing device or to use a double-seal.

Standard tray- cassettes sealed in MELAfo<sup>®</sup> (250 mm wide) must be taped and clasped additionally to ensure that the side-seals do not split open.

### Multiple wrapping

The pulsed vacuum method means it is possible to use multiple wrapping.

### Maximum loads

Loads should not exceed 3 kg of instruments or 0.9 kg of textiles.

### Mixed loads

If mixed loads of textiles and instruments are to be sterilized, then as far as possible the textiles should be above the instruments and direct contact with the instruments should be avoided.

Inclusion of textiles and instruments in the same sterilization container is not desirable.

Textiles should never come into direct contact with the walls of the chamber.

If different types of packaging are included in a load, then:

- Instruments and sterilization containers should be at the bottom
- Transparent and paper sterilization packaging should be at the top (but lower than textiles)

### Liquids

The appliance is not suitable for the sterilization of liquids!

### Suitability for sterilization

Relevant information provided by manufacturers of instruments and textiles about sterilization should be strictly observed.

#### 4.4 Closing the door

The door is closed by lightly applying pressure in the direction of the chamber flange and at the same time pressing down the sliding door catch. The display shows the message:



#### 4.5 Program selection

A program should be selected which is appropriate for the physical properties of the items being sterilized (and in particular their heat resistance) and the type of packaging (if any part of the load is wrapped, then either the "Universal Program" or the "Gentle Program" must be used).

By pressing the "Program selection" button it is possible to review the display of the following programs for selection:

Parameter/Application	Program name/Display message
<b>Universal program</b> at 134°C, 2 bar, and a sterilization time of 3.5 min Sterilization of wrapped items, in particular instruments (no Hollow A), or mixed loads (unwrapped/wrapped)	<div style="border: 1px solid black; padding: 5px; display: inline-block;"> <b>Universal Program</b>  <b>134°C wrapped</b> </div> <span style="float: right; text-align: right;">Program </span>
<b>Quick Program</b> at 134°C, 2 bar and a sterilization time of 3.5 min Sterilization <b>only of unwrapped instruments</b> (no Hollow A, no textiles) for rapid re-use (drying can be interrupted manually)	<div style="border: 1px solid black; padding: 5px; display: inline-block;"> <b>Quick Program</b>  <b>134°C unwrapped</b> </div> <span style="float: right; text-align: right;">Program </span>
<b>Gentle Program</b> at 121°C, 1 bar, sterilization time 15 min Sterilization of all types of wrapped items (except Hollow A), in particular large amounts of textiles or thermolabile materials (plastic, rubber), or mixed loads (wrapped/unwrapped)	<div style="border: 1px solid black; padding: 5px; display: inline-block;"> <b>Gentle Program</b>  <b>121°C wrapped</b> </div> <span style="float: right; text-align: right;">Program </span>
<b>Bowie &amp; Dick Test Program</b> at 134°C, 2 bar and a sterilization time of 3.5 min Used to check the operation of the autoclave (Steam penetration of special indicators)	<div style="border: 1px solid black; padding: 5px; display: inline-block;"> <b>Bowie &amp; Dick Test</b>  <b>134°C 2.2bar 3,5'</b> </div> <span style="float: right; text-align: right;">Program </span>
<b>Vacuum test-program</b> Used to check the autoclave for leaks, from a cold start	<div style="border: 1px solid black; padding: 5px; display: inline-block;"> <b>Vacuum test</b> </div> <span style="float: right; text-align: right;">Program </span>
<b>Basic display</b> (no program selected)	<div style="border: 1px solid black; padding: 5px; display: inline-block;"> <b>15:31:33</b>  <b>0.02bar 22°C</b> </div> <span style="float: right; text-align: right;">Program </span>

## 4.6 Program start

Press the "Start-Stop" button once the desired program is shown on the display. The availability of cooling water, and feed water will be checked automatically, with a conductivity measurement.

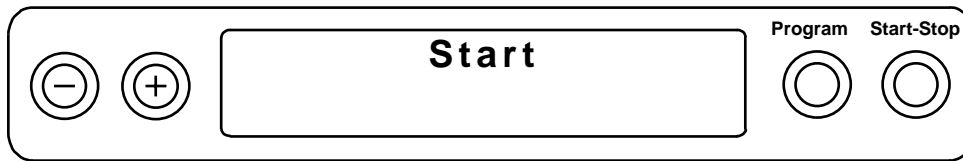

At the start of the quick program there will be an additional message "Warning: Only unwrapped instruments". This message must be acknowledged by pressing "Start" again.

## 4.7 Program progress

After starting the program, it will then progress automatically. The display shows the current program status as follows:

Program status	Display message
1. <b>Pre-vacuum</b> consisting of evacuation (removal of air) until the appropriate evacuation pressure is reached, followed by steam introduction up to slightly above atmospheric pressure. Display show pressure in chamber and steam temperature	<p><b>Pre-vacuum</b> -0.72 bar 60°C</p>
2. <b>Phase 1 and following</b> Depending on the program chosen and the temperature of the chamber at the start of the program, a number of cycles of steam inflow and outflow follow to ensure adequate penetration of super-heated steam into the items being sterilized.	<p><b>1. Fractionation</b> 0.69 bar 115°C</p>
3. <b>Heating phase</b> A heating-up phase follows. The continuous introduction of steam raises pressure and temperature in chamber to the values needed for the program	<p><b>Heat up</b> 1.80 bar 117°C</p>
4. <b>Sterilization phase</b> When the required pressure and temperature have been reached the sterilization proper then begins. The display shows alternately the pressure and temperature and the time remaining.	<p><b>Sterilization</b> 2.18 bar 135°C</p>
	<p><b>Sterilization</b> still 2 min 12 sec</p>
5. <b>Pressure release</b> After completion of the sterilization time, the pressure is released and the steam generator emptied. Pressure and temperature fall.	<p><b>Pressure release</b> 0.85 bar 96°C</p>
6. <b>1st drying phase (Flow drying)</b> After pressure release the drying phase begins. Throughout the drying phases of the program can be ended without an error report, since the sterilization itself has been completed. However, with the exception of the "Quick Program" you should normally wait until the drying is completed..	<p><b>Current drying</b> sin. 1' 0.9bar 85°C</p>
	<p><b>Immediate removal</b> Press STOP</p>

<p>7.</p>	<p><b>2nd drying phase (Vacuum drying)</b>                  The flow drying is then followed by a final pulsed vacuum drying phase. Throughout the drying phases the program can be ended without an error report, since the sterilization itself has been completed.                  However, with the exception of the "Quick Program" you should normally wait until the drying is completed..</p>	<div style="border: 1px solid black; padding: 5px; margin-bottom: 5px;"> <p style="text-align: right;">Program    Start-Stop</p> <p style="text-align: center;"><b>Vacuum-drying</b>                      sin. 2' -0.12 bar 60°C</p> <p style="text-align: right;"> <input type="radio"/>    <input type="radio"/> </p> </div> <div style="border: 1px solid black; padding: 5px; margin-bottom: 5px;"> <p style="text-align: right;">Programm   Start-Stop</p> <p style="text-align: center;"><b>Immediate removal</b>                      Press STOP</p> <p style="text-align: right;"> <input type="radio"/>    <input type="radio"/> </p> </div>
<p>8.</p>	<p><b>Program end</b>                  After ventilation of the chamber the program is completed.                  If a printer is attached and print-out "yes" is selected, the record will be printed-out immediately.</p> <p style="margin-top: 100px;">After the door has automatically unlocked the door can be opened to remove the sterilized objects.</p>	<div style="border: 1px solid black; padding: 5px; margin-bottom: 5px;"> <p style="text-align: right;">Program    Start-Stop</p> <p style="text-align: center;"><b>Quick Program</b>                      run successfully</p> <p style="text-align: right;"> <input type="radio"/>    <input type="radio"/> </p> </div> <div style="border: 1px solid black; padding: 5px; margin-bottom: 5px;"> <p style="text-align: right;">Program    Start-Stop</p> <p style="text-align: center;"><b>Please wait</b>                      Door unlocking</p> <p style="text-align: right;"> <input type="radio"/>    <input type="radio"/> </p> </div> <div style="border: 1px solid black; padding: 5px;"> <p style="text-align: right;">Program    Start-Stop</p> <p style="text-align: center;"><b>Open door</b>                      please</p> <p style="text-align: right;"> <input type="radio"/>    <input type="radio"/> </p> </div>

## 4.8 Print-out record

The print-out record contains the following information:

```

-----
MELAG Euroklav 29V-S
-----
Program      : Universal-program
              134°C wrapped
Date        : 03.04.2000
Time of day  : 13:10:30 (Start)
Batch number: 3
-----
Preheating   110.2 °C
Conductivity 14 µS/cm
-----
Program step  Press.  Temp.  Time
              bar     °C    min
Start        0.00    73.0   00:00
Pre-vacuum
Evacuation   -0.77    65.2   02:19
Steam entry  0.01    99.0   03:16
1.Fractionation
Steam entry  1.01    119.9  04:18
Press. release 0.20    104.8  04:49
2.Fractionation
Steam entry  1.01    120.0  05:52
Press. release 0.19    104.9  06:31
3.Fractionation
Steam entry  1.00    119.9  07:34
Press. release 0.20    105.0  08:17
4.Fractionation
Steam entry  1.00    120.0  09:23
Press. release 0.20    105.0  10:08
5.Fractionation
Steam entry  1.00    119.9  11:13
Press. release 0.20    105.2  12:01
Heat up      2.05    134.0  14:24
Steriliz.begin 2.05    134.0  14:24
Steriliz.end  2.17    136.6  17:54
Pressure release 0.47    118.4  18:36
Current-drying
Drying begin  0.47    118.4  18:36
Drying current 0.40    105.2  19:02
Drying pumping 1.11    108.1  19:35
Vacuum-drying
Drying begin  1.11    98.3   28:51
Drying sub atm. -0.60    88.6   30:13
Drying pumping 0.52    97.9   31:08
Drying end    0.51    95.2   39:19
End          0.12    86.6   39:19
-----
PROGRAM PROPERLY EXECUTED!
-----
Temperature  : 136.6 +0.1 /-0.1 °C
Pressure     : 2.17 +0.01/-0.01 bar
Sterilize time: 3 min 30 s
Time of day  : 13:49:49 (End)
-----
12 00000815 3.16 1.13
-----

```

Program

Date

Time of start

Running load number for the day

Pre-heating temperature

Conductivity of purified feed water

Program phases with the values for steam pressure and temperature, and time (relative to program start)

Final report

Mean sterilization temperature/ deviations

Mean sterilization pressure / deviations

Duration of sterilization

Time at end of program

Info-line with total number of loads, Works number and software version.



## 4.9 Removing the sterilized items

---

After opening the door the sterilized items can be removed.

**Be careful** when removing the sterilized items! Touching the metal surfaces can lead to burns. Always use the appropriate aids to lift the trays (MELAG-tray lever, standard tray-lifter) or wear suitable hand protection.

## 4.10 Sterile storage

---

After removing wrapped sterile items, the wrapping should be checked for any signs of damage. If it is defective (e.g. split seals) then the sterilization of the items must be repeated after the items have been re-wrapped.

It is important for sterile storage that the items have been properly dried. The Euroklav<sup>®</sup>29V-S provides very good drying if the program has not been interrupted before its completion and the autoclave has been properly loaded (see Section 4.2). Directly after sterilization there may still be residual condensation on the items or the container. Because the items are hot on removal, this will usually evaporate quickly. The German industrial standard DIN 58953 Part 7 Section 7 contains the following comment about residual moisture on paper wrapping or transparent sterilization paper after sterilization: "...small amounts of water on the wrapping are unproblematic, provided they have evaporated within 30 minutes after removal from the steam sterilizer...."

After cooling, wrapped sterilized objects should be stored in a place where they are **protected from dust** (e.g. instrument cupboard). Given proper storage, DIN 58953 Part 7 gives the following guidelines for the maximum storage periods for sterilized objects: in basic wrapping (e.g. transparent sterilization foil) up to 6 weeks; in double-wrapping up to 6 months.

## 4.11 Sterilization frequency / pauses

---

After completing or terminating the drying phase, the autoclave can be reloaded and started immediately. However, continuous operation can lead to increased development of water vapour from the water storage tank. This is not harmful for the Euroklav<sup>®</sup>29V-S provided there is sufficient space around it for ventilation (10-20 cm) and it is not fully enclosed (e.g. in a cupboard). In order to reduce formation of water vapour it is advisable to have a 20 min pause between loads.

The Euroklav<sup>®</sup>29V-S should never be installed in an enclosed position, and should always have sufficient space around it.

## 4.12 Manual termination of program

### 4.12.1 Termination of sterilization

A program can be terminated at any time by pressing the "Start-Stop" button. If the program has not yet reached the drying phase then the items will be **non-sterile!**

**Warning!** Steam may escape when the autoclave door is opened.

If the sterilization phase of the program had not been completed, then it is advisable to carry out an empty sterilization run before reusing the autoclave.

Operation		Display
1.	<p>Press the "Start-Stop" button To confirm, press the "Start-Stop" once again within 5 seconds.</p> <p>If no confirmation is given then the program resumes normally.</p>	<p>The display shows a rectangular box with the text "Stop program ?" and "Press STOP" below it. To the right of the box are two circular buttons labeled "Program" and "Start-Stop".</p>
2.	<p>If confirmation is given then the program stops.</p> <p>The pressure inside the autoclave will then be equalised, either by pressure release, or by ventilation (if vacuum inside).</p>	<p>The display shows two sequential screens. The first screen shows a rectangular box with the text "Program stopped". The second screen shows a rectangular box with the text "Pressure release" and "1.52 bar 112°C" below it. Both screens have two circular buttons labeled "Program" and "Start-Stop" to the right.</p>
3.	<p>After pressure equalisation, the display will alternately show the messages "Terminated" and an offer to quit the program termination.</p>	<p>The display shows two sequential screens. The first screen shows a rectangular box with the text "Stop / end" and "0.02 bar 88°C" below it. The second screen shows a rectangular box with the text "Acknowledge with button ' - '" below it. Both screens have two circular buttons labeled "Program" and "Start-Stop" to the right.</p>
4.	<p>To undo the program termination, press the " - " button.</p> <p>- Otherwise, After the message "Please wait, Door unlocking", the display for the selected program reappears.</p>	<p>The display shows a rectangular box with the text "Gentle Program" and "121°C wrapped" below it. To the right of the box are two circular buttons labeled "Program" and "Start-Stop".</p>

4.12.2 Terminate drying

A program can also be terminated during the drying phase, Since in this case the sterilization has been completed, the items in this case can be treated as sterilized.

However, depending on the stage at which the drying program is interrupted, the load may not have dried sufficiently, and wrapped items in particular may not be dry enough for sterile storage. We therefore recommend that you do not interrupt the drying process for wrapped items in the "Universal Program" or "Gentle Program".

With the "Quick Program" it may be desirable to interrupt the drying program so that items can be used again. The unwrapped items will dry as they are cooling down.

**Warning!** If the drying process is interrupted than steam may be released when the door of the autoclave is opened.

Operation		Display
1.	<p>The autoclave is in the drying phase. The display shows the drying time</p> <p>alternately with</p> <p>the option to terminate the drying phase</p>	
2.	<p>Press the "Start-Stop" button To confirm, press the "Start-Stop" once again within 5 secs.</p> <p>If no confirmation is given then the program resumes normally.</p>	
3.	<p>If the "Start-Stop" button has been pressed again to confirm then the program terminates.</p>	
4.	<p>After the ventilation of the chamber the display shows that the program has been successfully completed.:</p> <p>alternately with:</p> <p>If a printer is connected and an immediate report has been selected, this is printed-out, together with confirmation that the drying process has been terminated.</p>	

## 4.13 Reaction to warnings / error messages

---

The Euroklav®29V-S has a number of safety features and an extensive integrated control and monitoring system, in order to ensure the greatest possible level of safety for the sterilization process, and to eliminate risks for the patients and operators.

Various aspects of the operation of the appliance, such as pressure and temperature sensors are automatically checked when the autoclave is switched on.

The power supply, and the quantity and quality of the feed water and cooling water are checked before a program can start.

A successful program start is followed in the next stages by the monitoring of all parameters of relevance for the sterilization. If any limit values for the individual program phases are exceeded then there is a malfunction report and the program is automatically interrupted.

In addition to messages, warnings or malfunction reports on the display, if a printer is connected then a printout will provide details of the type of malfunction and when it occurred.

If any such warning message occurs then you should consult Section 7, which provides detailed advice and possible operational errors.

## 4.14 Operational pauses

---

In general, the door should only be leant to during operational pauses in order to reduce wear on the door seal and to avoid premature failure or sticking.

In the event of longer breaks, such as during vacations, the cooling water supply should be turned off (and the feed water supply from the water purifier if one is connected). We recommend that you do not disconnect the power supply. You should however set the automatic preheating option to "No" (see Section 6.5) . In this way, the vacuum pump will automatically turn over for a short period at midnight every day, which ensures that the pump will run smoothly even after longer periods of inoperation.

## 5 Closing down / Transport / Reinstallation

---

When closing down and transporting the autoclave you should proceed as follows:

- Switch off the power.
- Disconnect from the mains, allow the autoclave to cool down.
- Turn off cooling water and feed water supplies.
- Disconnect pipes at rear of autoclave.
- If transporting the autoclave with trays and tray rack assemblies in place, then protect the inside surface of the door by including a sheet of foam or similar material.
- **Warning! To avoid damage use the original packaging when transporting the autoclave. If the appliance may be exposed to frost in transit then follow the relevant service instructions!**
- When setting the appliance up for reuse after transport or repairs then proceed in accordance with Sections 2 and 3.

## 6 Special functions

### 6.1 Water quality (conductivity)/ Chamber preheating temperature

By repeatedly pressing the "-" button, the preheating temperature of the chamber and the conductivity of the purified feed water used for steam generation can be displayed alternately.

Operation	Display message
<p>1. Press down the "-" button to display the conductivity of the feed water <math>\mu\text{S/cm}</math></p> <p>Release the "-" button to return to the basic display (as shown here) or the program status</p> <p>Press the "-" button repeatedly and hold down: Display shows the pre-heating temperature of the chamber.</p>	

### 6.2 Selecting extra drying

The standard drying times for the various programs provide adequate drying if the autoclave has been loaded correctly (see Section 4.2). Nevertheless, with certain loads residual moisture may remain. By selecting the "Extra drying" function, the drying time can be extended by 50%:

Operation	Display message
<p>At the start of the program, press the "+" button. The display shows a message confirming the extra drying, and then the program runs as described in Section 4.7, but with 50 % longer drying time.</p>	

### 6.3 Records / Load documentation

In order to document the progress of the sterilization program, then the processor memory stores records of the last 40 programs.

These records can be downloaded at a later stage via the serial interface (RS232).

When the memory is full (40 program runs) then before the start of the next run the oldest record will automatically be overwritten. If an external printer is connected (and operable) and the option "Immed. print-out? No" has been selected, then confirmation will be requested before the oldest record is overwritten (see Section 7.3).

Hardware details and the nature of the print-out documentation is provided in the following sub-sections.

## 6.3.1 Record print-out

### 6.3.1.1 External printer

#### 6.3.1.1.1 Connecting the external MELAprint® 42 printer

In order to connect a printer to the autoclave then a printer cable should be connected between the 9-pole socket on the front of the autoclave (see page: 4, Fig. 1, Pos. 8) s and the 25-pole on the back of the printer (ensuring a good connection and tightening the locking screws).

The power supply to the printer is provided by the power unit supplied with the printer, which connects to the socket on the rear of the printer.

The printer is ready for operation when the voltage lamp "P" shines and the status display (Online/Offline) "SEL". The operating manual of the printer includes further details, including the assembly of an external paper feed, inserting paper, and the general operation of the printer.

#### 6.3.1.1.2 Initializing the printer

After connecting the printer to the autoclave it must be registered with the autoclave processing unit (initialized). Proceed as follows:

Operation	Display message
1. Switch on autoclave Display shows time, pressure and temperature	
2. Hold down "+" button and also press "-" button. Select "Function" menu, sub-menu "Print"	
3. Press "Program" button, Select "Print" menu sub-menu "File transmission"	
4. Press "Program" button, Select "File transmission" Display shows current status e.g. "No printer"	
5. Press "+" (or "-") button until display shows "External printer"	
6. Press "Program" button, Confirm the setting, return to "Print" menu	
7. Press "Start-Stop" button, return to the "Function" menu	
8. Press "Start-Stop" button, Quit the "Function" menu and return to the initial display	

## 6.3.1.2 Connection to an external PC

### 6.3.1.2.1 Installation

Records and archives can also be kept by using an external PC. This requires a suitable connection between the serial port of the PC and the printer port of the autoclave.

For data transfer and data processing then you must first install the program MELAwin® on the PC.

### 6.3.1.2.2 Downloading to a PC

After connecting the autoclave to a PC the print-out option for "External PC" must be selected. Proceed as for an external printer (see Section 6.3.1.1.2), , but under Point 5 use the "+" or "-" button to select the "External PC" option.

### 6.3.1.3 No printer

In order to select the option "No printer", proceed as described as in Section 6.3.1.1.2. Under Point 5, however, use the "+" or "-" button to reach the setting "No printer".







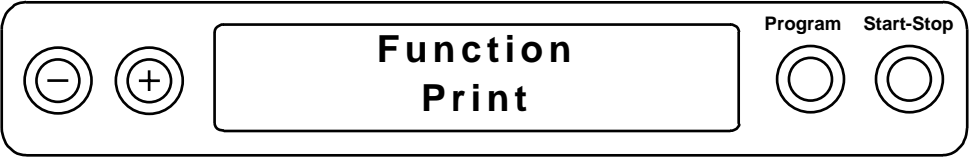

## 6.3.2 Immed. print-out? Yes/No

When an external printer is fully installed, a print-out can be produced automatically at the end of each program run by selecting the following options after switching on the autoclave:

Operation		Display message
1.	Hold down "+" button and also press "-" button. Select "Function" menu, sub-menu "Print"	
2.	Press "Program" button, Select "Print" menu sub-menu "File transmission"	
3.	Press "+" button, select sub-menu "Immed. print-out?" Display shows current option, here e.g. "No"	
4.	The button "Program" can be used to switch between "Yes" and "No" Press "Program" button, Select "Yes" option	
5.	Press "Start-Stop" button, Confirm the setting and return to "Function" menu, sub-menu "Print"	
6.	Press "Start-Stop" button, Quit the "Function" menu and return to the initial display	

## 6.3.3 Printing out stored records

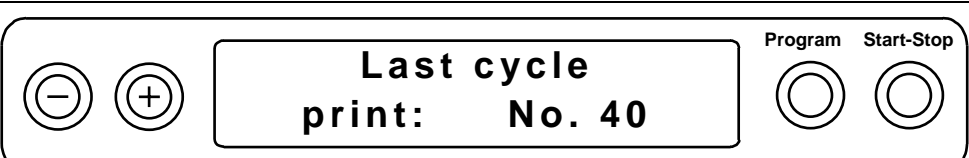

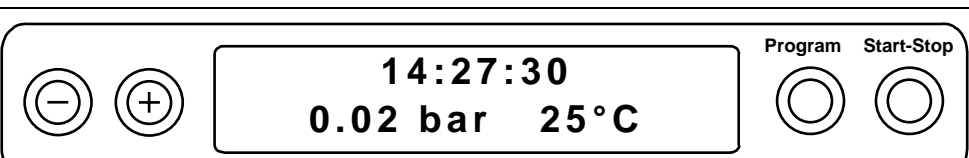
When an external printer is fully installed, a print-out of selected records from the memory can be produced by selecting the following options after switching on the autoclave:

Operation		Display message
1.	Hold down "+" button and also press "-" button. Select "Function" menu, submenu "Print"	
2.	Press "Program" button, Select "Print" menu, submenu "File transmission"	
3.	Press "+" (or "-" ) until the submenu "Last cycle print:" appears on the display	
4.	Press "Program" button, the cycle record number flashes	
5.	To select another number, press the "-" or "+" button until the right number is reached, e.g. here No. 25	
6.	Press "Program" button to start the print-out of the selected record, (or to terminate press "Start-Stop" and return to the "Function" menu)	
7.	If you wish to print further records then return to Point 4, or...	
8.	... to terminate press "Start-Stop" and return to the "Function" menu	
9.	Press the "Start-Stop" button to return to the initial display	



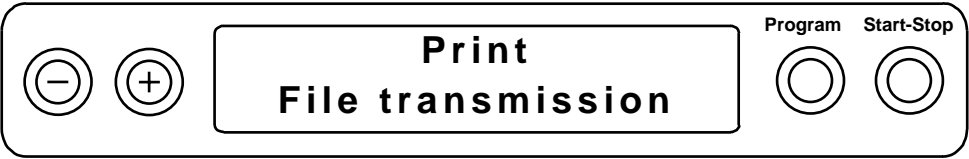

**6.3.4 Print all stored cycle records**

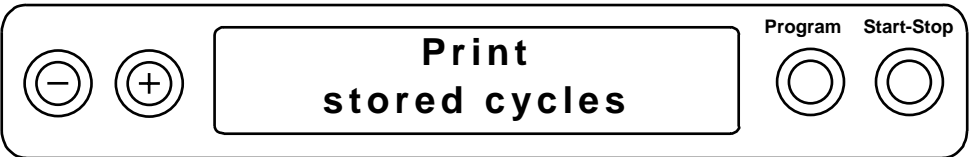
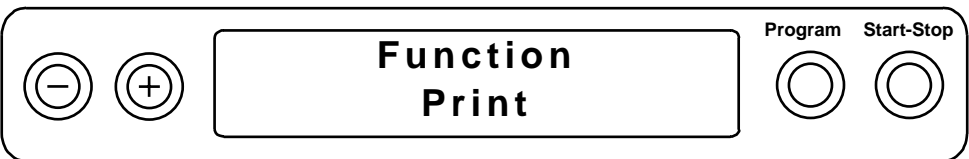
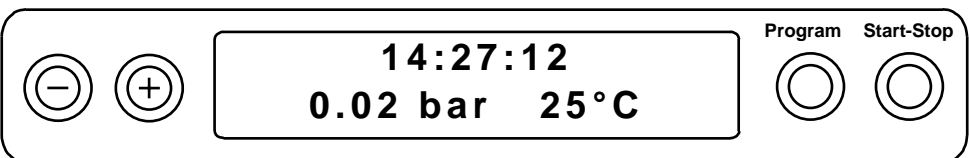
In order to print-out all stored cycle records (with a fully installed external printer) then select the following options after switching on the autoclave:

Operation		Display message
1.	Hold down "+" button and also press "-" button. Select "Function" menu, submenu "Print"	
2.	Press "Program" button, Select "Print" menu, submenu "File transmission"	
3.	Press "+" (or "-" ) until the submenu "Print stored cycles" appears on the display	
4.	Press "Program" button to start the printout of all the stored records (up to 40!), or to terminate press "Start-Stop" and return to the "Function" menu (Once printing has started termination is only possible by switching off the power!)	
5.	When the print-out is complete, the display again shows the submenu :	
6.	Press the "Start-Stop" button to return to the "Function" menu...	
7.	...and then press "Start-Stop" again to return to the initial display	

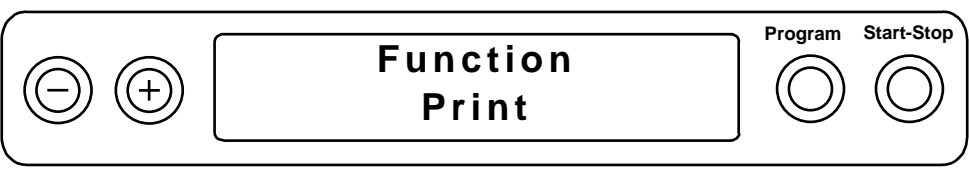
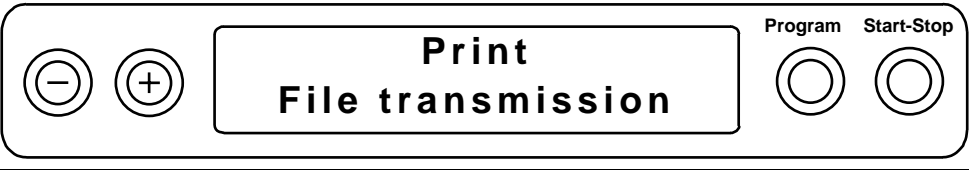

## 6.3.5 Display printer memory status

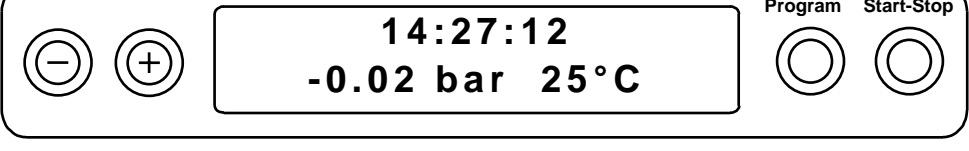
With a fully installed external printer, the status of the printer memory can be displayed as follows:

Operation		Display message
1.	Hold down "+" button and also press "-" button. Select "Function" menu, submenu "Print "	
2.	Press "Program" button, Select "Print" menu, submenu "File transmission"	
3.	Press "+" (or "-" ) button until the display shows the memory status, e.g.:	
4.	Press the "Start-Stop" to return to the "Function" menu "	
5.	and press "Start-Stop" again to return to the starting display	



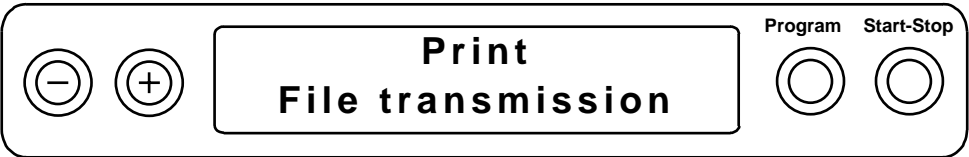
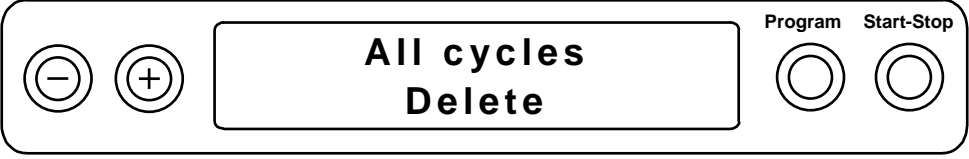

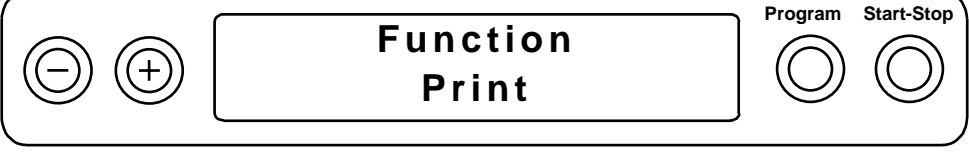
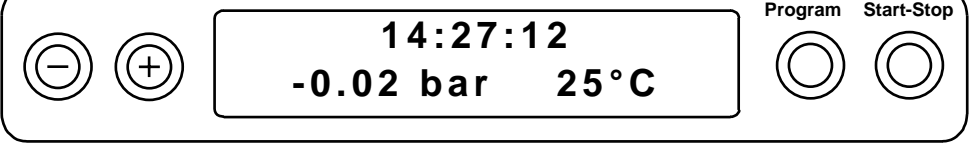
## 6.3.6 Deleting cycle records

In order to delete cycle records (e.g. in the event of the warning message "Printer memory full", with the option "Immed. print-out? No", selected (see Section 7.3), then after switching on the appliance proceed as follows:

Operation		Display message
1.	Hold down "+" button and also press "-", Select "Function" menu, submenu "Print"	
2.	Press "Program" button, Select "Print" menu, submenu "Data transfer"	
3.	Press "+" (or "-") until the display shows "All cycles delete"	
4.	Press the "Program" button to delete all records (or press "Start-Stop" to terminate)	
5.	Then press "Start-Stop" to return to "Function" menu ...	
6.	...and press "Start-Stop" again to return to the starting point	

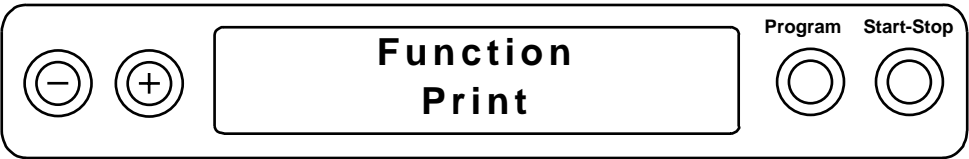

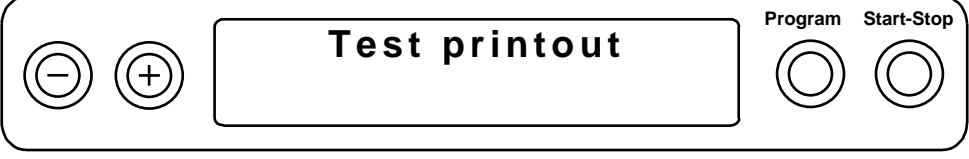

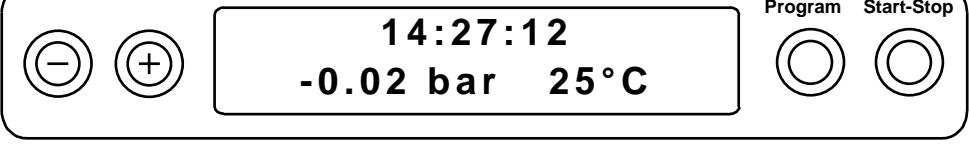

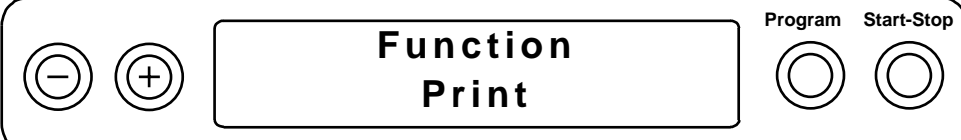

## 6.3.7 Test print-out

In order to check the printer and its connection to the autoclave, a test print-out can be made as follows:

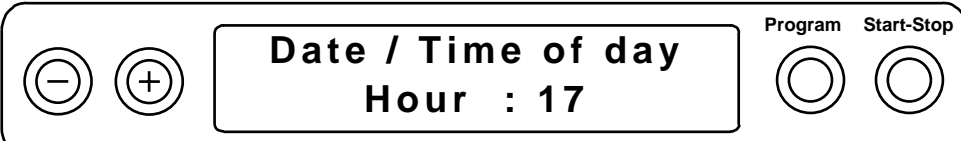
Operation		Display message
1.	Hold down "+" button and also press "-", Select "Function" menu, submenu "Print"	
2.	Press "Program" button, Select "Print" menu, submenu "File transmission"	
3.	Press "+" (or "-") until the display shows "Test printout"	
4.	Then press the "Program" button for a test print-out (or press "Start-Stop" to terminate)	
5.	Then press "Start-Stop" to return to the "Function" menu	
6.	and press "Start-Stop" again to return to the starting position	

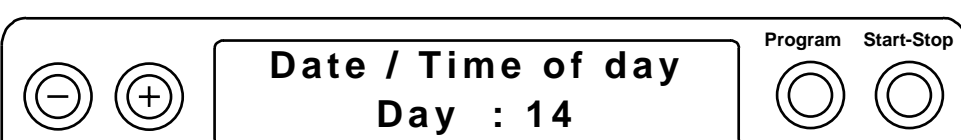
## 6.4 Resetting date and time

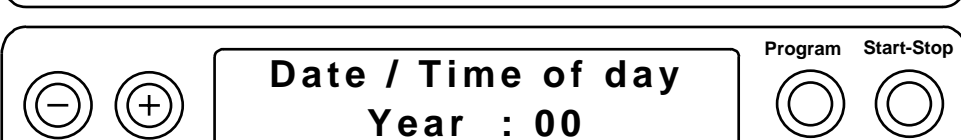
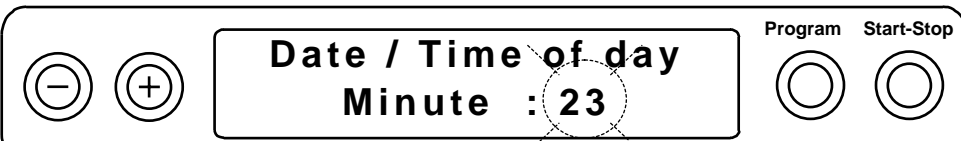
The date and time can be reset if necessary (e.g. winter time/summer time) as follows:

Operation	Display message
1. Hold down "+" button and also press "-" button. Select "Function" menu, submenu "Print"	
2. Press "+" (or "-"), until the display shows the submenu "Date/Time of day".	
3. Press "Program", the display shows the current hour (24-hour clock) (here for example 17.00)	
4. by pressing the "+" (or "-") button the following options can be selected	
	
	
	
	
5. After finding the required option, e.g. "Minute", press the "Program" button and the current value flashes	
6. Press "+" or "-" to increase or reduce the value:	

Operation	Display message
7. Press "Program" to confirm the new value, which then stops flashing. If more adjustment are necessary, return to Point 4 and begin again,...	
8. ...or press "Start-Stop" to return to the "Function" menu, and	
9. Press "Start-Stop" again to return to the starting point	

## 6.5 Automatic preheating

The Euroklav®29V-S has a preheating function by means of which the autoclave chamber can be heated to the necessary temperature before a program starts, or can be maintained at this temperature between cycles. This not only shortens the time for each cycle but also reduces condensation on the walls of the chamber which helps to provide very good drying performance. If the automatic preheating is activated, then this begins as soon as the power is switched on. In the default setting on delivery the automatic preheating is on.

The current setting for the automatic preheating can be changed as follows:

Operation	Display message
1. Hold down "+" button and also press "-" button. Select "Function" menu, sub-menu "Print"	
2. Press "+" (or "-") until the display shows the submenu "autom. Preheating" ..	
3. Press "Program", and the display shows the current option, here "Preheating Yes"	
4. Pressing the "Program" button now alternates between the options "Preheating Yes/No", here e.g. "No"	
5. When the desired option has been selected press "Start-Stop" and return to the "Function" menu, then	

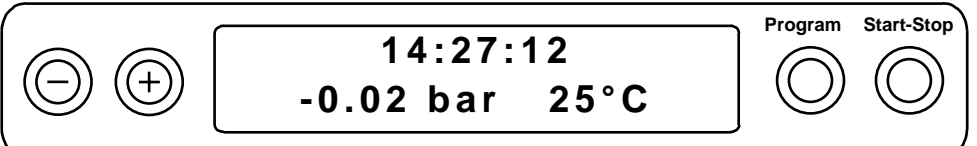
<p>6. ..press "Start-Stop" again to return to the starting point</p>	
--	--

### 6.6 Total load count

The Euroklav®29V-S keeps a running count of the total number of loads sterilized, and this be displayed as follows:

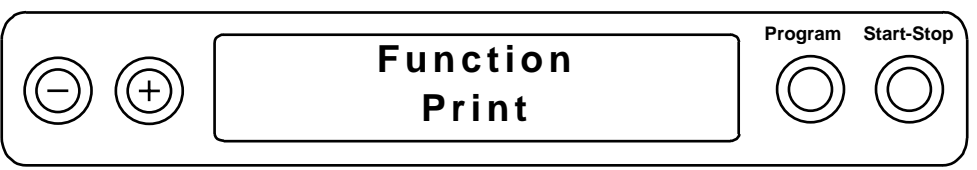
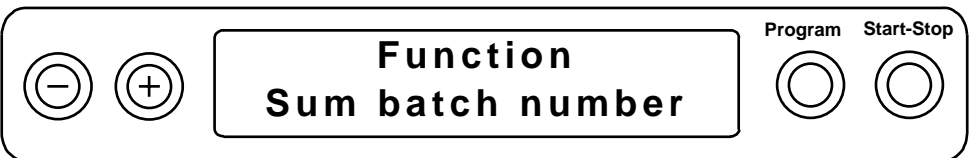
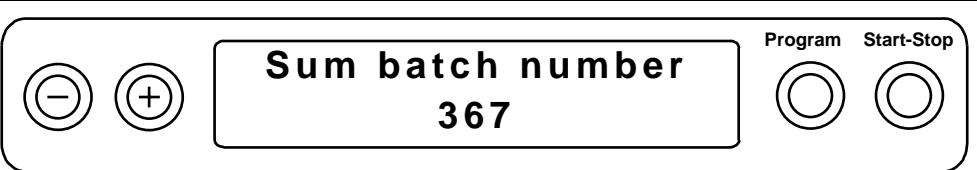
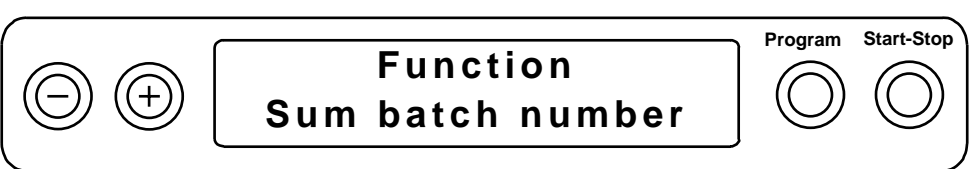
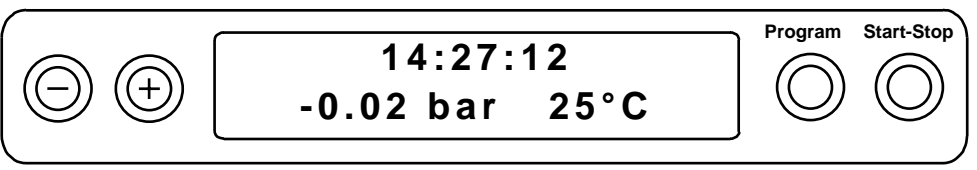
Operation	Display message
<p>1. Hold down "+" button and also press "-", Select "Function" menu, submenu "Print"</p>	
<p>2. Press "+" (or "-") until the display shows the submenu "Sum batch number".</p>	
<p>3. Press "Program", the display shows the current total load count, e.g.:</p>	
<p>4. Close by pressing "Start-Stop", and return to the "Function" menu, then</p>	
<p>5. Press "Start-Stop" again to return to the starting point</p>	

## 6.7 Distilled / demineralized water supply

The Euroklav®29V-S allows a choice between external and internal distilled / demineralized water, the selection being made as follows:

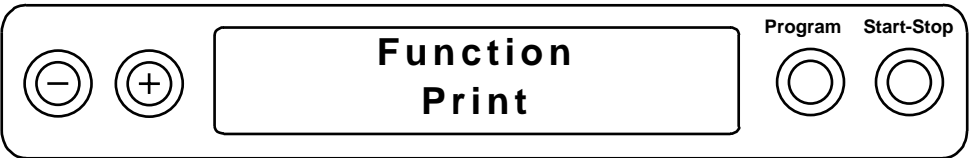
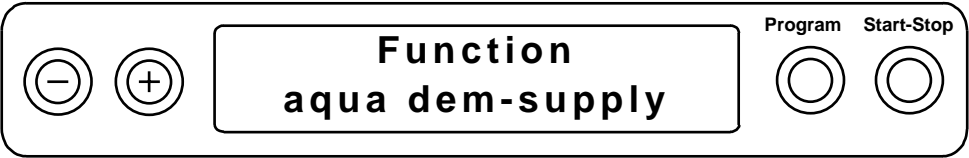
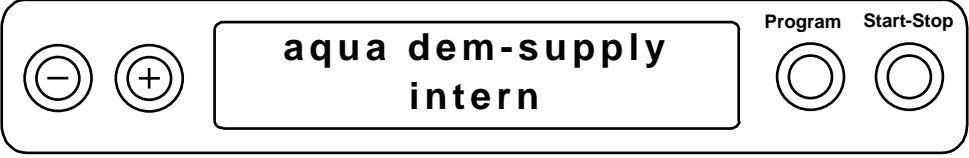
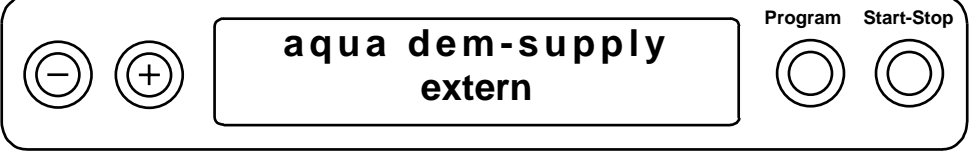
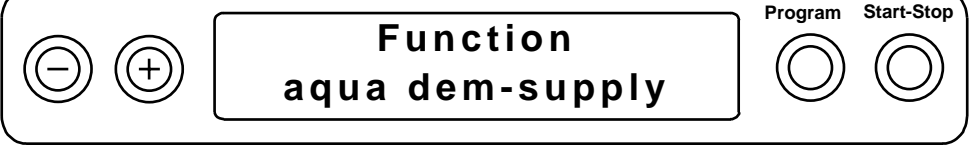
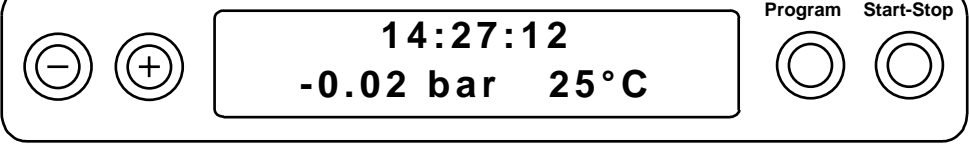
Operation	Display message
1. Hold down "+" button and also press "-" button. Select "Function" menu, sub-menu "Print"	
2. Press "+" or "-" button until the display shows the submenu "aqua dem supply".	
3. Press "Program" button, the display will show the current option, here "intern"	
4. Pressing the "Program" button switches between the options "internal" and "extern" (press again to return)	
5. When the correct option has been selected, press the "Start-Stop" button to return to the Function menu and ..	
6. Press the "Start-Stop" button to return to the initial position	



## 6.8 Water system

The Euroklav®29V-S also allows the choice between closed-loop and one-way system. In the closed-loop system the demineralized or distilled water is reused. In the one-way system the demineralized/distilled water is only used once, which is particularly good for the instruments and the sterilizer, but which leads to increased water consumption (approx. 500 ml). The water system is selected as follows:

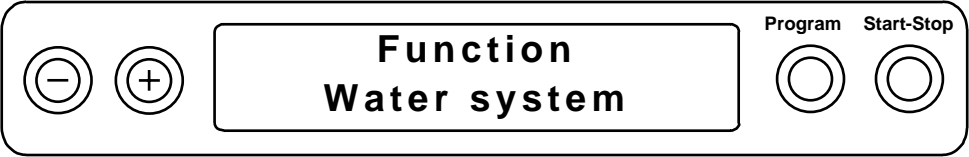
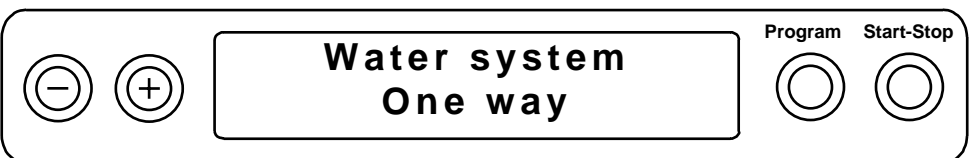
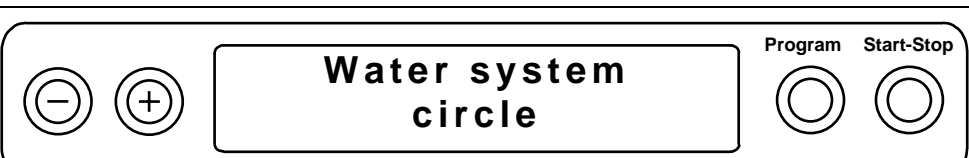
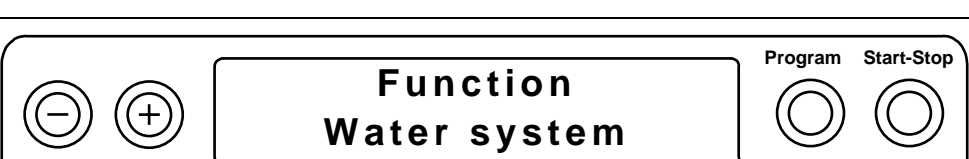
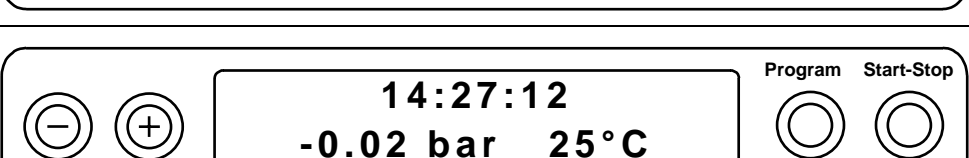
Operation		Display message
1.	Hold down "+" button and also press "-" button. Select "Function" menu, submenu "Print"	
2.	Press "+" or "-" until the display shows the submenu "Water system".	
3.	Press "Program" button and the display shows the current option, here "One way"	
4.	Press the "Program" to switch between the option "One way" and "circle" (press again to return)	
5.	When the desired option has been selected, press the "Start-Stop" button to return to the "Function" menu and	
6.	Press the "Start-Stop" button again to return to the initial position	

## 6.9 Program modifications

The standard programs are designed to meet most practical operational needs (subatmospheric pulsing, heating, sterilization, pressure release, drying, and ventilation) and to display the parameters of most interest (pressure, temperature, time).

The operator is responsible for ensuring that the autoclave is not overloaded, and that the load is arranged properly to ensure good drying.

There are two standard options "Automatic preheating" and "Supplent drying".

Any further program modification to suit specific individual requirements should only be carried out by authorised personnel, after consultation with your dealer or with the experts at MELAG.

## 7 Operational errors / Malfunctions

---

### 7.1 What to do if the autoclave malfunctions

---

If the autoclave does not seem to be working properly (e.g. poor drying, warnings, or error reports) then follow these instructions in order to exclude possible operational errors. ..Following these instructions continue to work with the autoclave. If the malfunction occurs repeatedly then contact our dealer, and authorised MELAG customer service or contact MELAG directly. You should describe the problem precisely and include the works number of your appliance.

### 7.2 Malfunctions without display messages

---

#### 7.2.1 No display

---

After switching on the autoclave, the display should show the initial setting (see Section 4.1.2).

##### **If there is no display: Check:**

Exchange the two power fuses (page 4, Fig. 1, Pos. 9) under the switch as follows: Disconnect the power cable and remove the screw cap over the fuses using a screwdriver or a coin. Exchange the fuses (two reserve fuses are on the inside of the door lining) then replace the screw cap and reconnect the autoclave to the power supply. If there is still no display when the autoclave is switched on, or if the display blacks out repeatedly, please inform your specialist dealer. If you exchange the fuses, order two new spare fuses through your dealer (MELAG-Art. No. 57590).

1. Is the cable plugged into the mains?
2. Is the mains supply OK: (if necessary check with another appliance).
3. Exchange the two power fuses (page 4, Fig. 1, Pos. 9) under the switch as follows: Disconnect the power cable and remove the screw cap over the fuses using a screwdriver or a coin. Exchange the fuses (two reserve fuses are on the inside of the door lining) then replace the screw cap and reconnect the autoclave to the power supply. If there is still no display when the autoclave is switched on, or if the display blacks out repeatedly, please inform your specialist dealer. If you exchange the fuses, order two new spare fuses through your dealer (MELAG-Art. No. 57590).

#### 7.2.2 Excessive water consumption

---

The consumption of distilled or demineralized water will vary depending on the program and the load in the autoclave. If much more water is consumed than the amount specified in the Annex (see Section 9.2), then you should:

1. Check that the autoclave has been set up correctly, and is higher at the front, so that condensation can flow out at the back (see Section 2.3).
2. Check that the condensation outflow is not blocked by dropped, instruments, filter paper, etc. on the floor of the pressure chamber.
3. If neither of these measures help to reduce water consumption, please inform your specialist dealer.

#### 7.2.3 Poor drying

---

Good drying depends only on the correct operation of the autoclave, but also on the way the autoclave is loaded. If drying is not satisfactory:

- 1. Check that the autoclave has been set up correctly, and is higher at the front, so that condensate can flow out at the back.
- 2. Check that the condensation outflow is not blocked by dropped, instruments, filter paper, etc. on the floor of the pressure chamber.
- 3. Check that the maximum load has not been exceeded (particularly for textiles), that the autoclave has been loaded properly (no direct contact with the walls of the pressure chamber), and that the appropriate tray-rack assembly has been used (see Section 4.2).
- 4. Activate automatic pre-heating (see Section 6.5).
- 5. Start with "Additional heating" (see Section 6.2).
- 6. If none of these measures help to reduce water consumption, please inform your specialist dealer.

### 7.3 Warning messages

For the following warning messages, please observe the comments made and restart the program in question. If the warning occurs repeatedly please consult your specialist dealer.

Warning message	Cause / Remedy
<div style="border: 1px solid black; padding: 5px; text-align: center; margin-bottom: 5px;"><b>WARNING!</b></div> <div style="border: 1px solid black; padding: 5px; text-align: center; margin-bottom: 5px;"><b>Door open</b></div> <div style="border: 1px solid black; padding: 5px; text-align: center; margin-bottom: 5px;"><b>No start possible</b></div> <div style="border: 1px solid black; padding: 5px; text-align: center;"><b>Acknowledge with button " - "</b></div>	<p>Door not closed properly</p> <ul style="list-style-type: none"> <li>▪ Press grip down until contact is made (display should then show "Door closed")!</li> </ul>
<div style="border: 1px solid black; padding: 5px; text-align: center; margin-bottom: 5px;"><b>WARNING!</b></div> <div style="border: 1px solid black; padding: 5px; text-align: center; margin-bottom: 5px;"><b>Water supply</b></div> <div style="border: 1px solid black; padding: 5px; text-align: center; margin-bottom: 5px;"><b>aqua dem/dest refill !</b></div> <div style="border: 1px solid black; padding: 5px; text-align: center; margin-bottom: 5px;"><b>No start possible</b></div> <div style="border: 1px solid black; padding: 5px; text-align: center;"><b>Acknowledge with button " - "</b></div>	<ul style="list-style-type: none"> <li>• This message appears when the supply of demineralized/distilled water is set to "internal", so that water is supplied from the internal tank</li> <li>• If the water level in the storage tank (right chamber) falls below the minimum mark the signal will be triggered             <ul style="list-style-type: none"> <li>• Check the level of water in the tank, and refill to max. with distilled or demineralized water of the appropriate quality</li> </ul> </li> </ul>
<div style="border: 1px solid black; padding: 5px; text-align: center; margin-bottom: 5px;"><b>Warning Water supply</b></div> <div style="border: 1px solid black; padding: 5px; text-align: center; margin-bottom: 5px;"><b>Check supply aqua dem/dest</b></div> <div style="border: 1px solid black; padding: 5px; text-align: center; margin-bottom: 5px;"><b>No start possible</b></div> <div style="border: 1px solid black; padding: 5px; text-align: center;"><b>Acknowledge with button " - "</b></div>	<ul style="list-style-type: none"> <li>• This warning appears when the supply of demineralized/distilled water is set to "external". IN this case the water will be supplied from an external water purifier.</li> <li>• The internal flow monitor for the demineralized/distilled water supply has not reacted (when filling the steam generator):</li> <li>• Supply from MELAdem®47:             <ul style="list-style-type: none"> <li>• Check the water purifier. If necessary open the water intake tap. If the pressure water storage unit is empty wait approximately 1 hour before restarting the program. If the message reappears repeatedly, have the water purifier serviced.</li> </ul> </li> <li>• Supply from MELAdem®37:             <ul style="list-style-type: none"> <li>• Check the water purification system. If necessary open the water intake tap. If the message reappears repeatedly, have the water purifier serviced</li> </ul> </li> </ul> <p>If the autoclave is being used for the first time or is being restarted after a break then this message may simply be caused by the fact that the tubes were initially empty - just repeat the start procedure..</p>

Warning message	Cause / Remedy
<div style="border: 1px solid black; padding: 5px; text-align: center; margin-bottom: 5px;"><b>WARNING!</b></div> <div style="border: 1px solid black; padding: 5px; text-align: center; margin-bottom: 5px;"><b>Wastewater tank discharge</b></div> <div style="border: 1px solid black; padding: 5px; text-align: center; margin-bottom: 5px;"><b>No start possible</b></div> <div style="border: 1px solid black; padding: 5px; text-align: center;"><b>Acknowledge with button " - "</b></div>	<ul style="list-style-type: none"> <li>• This warning appears if the wastewater tank (left tank) is full.</li> <li>• The warning is generated when the water reaches the maximum level in the container.</li> <li>• Empty the tank as follows:             <ul style="list-style-type: none"> <li>• Pull on the left plug on the front of the autoclave and withdraw the emptying pipe as far as possible.</li> <li>• Hold the end of the pipe over a container (min. capacity 5 litre) standing on the floor. pull the stopper out of the pipe and allow the water to drain out.</li> <li>• When all the water has drained away, replace the stopper in the pipe, and push the pipe back into the opening on the front of the autoclave.</li> <li>• The message can then be acknowledged.</li> </ul> </li> </ul>
<div style="border: 1px solid black; padding: 5px; text-align: center; margin-bottom: 5px;"><b>Water quality bad</b></div> <div style="border: 1px solid black; padding: 5px; text-align: center;"><b>Exchange module/cartridge</b></div>	<p>Conductivity of the demineralized or distilled water is above the first limit value, a start is possible by pressing the "Start" button once more:</p> <ul style="list-style-type: none"> <li>▪ For the one-way option             <ul style="list-style-type: none"> <li>• Empty water from storage container (right chamber), clean tank with distilled/demineralized water and refill to max. with purified water to specifications</li> </ul> </li> <li>• For the closed-loop option             <ul style="list-style-type: none"> <li>• Empty water from both chambers of the internal storage tank, clean tank with distilled/demineralized water and refill to max. with purified water to specifications.</li> </ul> </li> <li>• Water from the MELAdem<sup>®</sup>47: The demineralization cartridge in the ion exchanger may be exhausted. Exchange in accordance with the operating manual.</li> <li>• Water from the MELAdem<sup>®</sup>37: The demineralization unit may be exhausted. Exchange in accordance with the operating manual.</li> <li>• Water from other purification equipment: Exchange the demineralization / deionisation unit in accordance with the manufacturer's instructions.</li> </ul> <p>After taking the appropriate steps, carry out the program start. When starting for the first time after exchanging the purified water container, or after maintenance of the water purification equipment, there may be another report because at first the supply tube and /or measuring cell will not have been washed out with fresh, pure water.</p>
<div style="border: 1px solid black; padding: 5px; text-align: center; margin-bottom: 5px;"><b>Water quality insufficient</b></div> <div style="border: 1px solid black; padding: 5px; text-align: center; margin-bottom: 5px;"><b>No start possible</b></div> <div style="border: 1px solid black; padding: 5px; text-align: center;"><b>Acknowledge with button " - "</b></div>	<p>Conductivity of the demineralized or distilled water exceeds the second limit value - a program start is no longer possible: Proceed as above for "Water quality poor".</p>

Warning message	Cause / Remedy
<p style="text-align: center;"><b>WARNING!</b></p> <p style="text-align: center;"><b>Sterile filter Replace !</b></p> <p style="text-align: center;"><b>Acknowledge with button " - "</b></p>	<p>The pressure for the ventilation drying lies outside the permitted range. The report comes at the end of the program, and as the last line of the print-out:</p> <ul style="list-style-type: none"> <li>▪ The sterile filter may be clogged or torn. Exchange the sterile filter (MELAG Art. No.: 53390).</li> </ul>
<p style="text-align: center;"><b>Printer is Not ready</b></p>	<p>Communication with the printer via the serial interface has been interrupted. This message appears when a report cannot be printed out. It is displayed for 20 seconds. If the printer becomes operational during this period the cycle record prints out:</p> <ul style="list-style-type: none"> <li>• The autoclave may be operated without a printer. Check under the "Data transfer" menu that the option "No printer" has been selected. (see Section 6.3.1.3)</li> <li>• Check the cable connection between the printer and the autoclave.</li> <li>• Check the power supply to the printer. In the MELAprint®42 the red light should indicate 'power on'</li> <li>• The printer may be "Offline". Select "online" (MELAprint®42, press "SEL" button, green LED "SEL" should shine)</li> </ul>
<p style="text-align: center;"><b>Printer memory full</b></p>	<p>The internal printer memory is full (40 cycles recorded), an external printer is registered, and in the "Print" menu the option "Immed. print-out? No" is selected. The message is displayed when a program is started. Pressing the "Start / Stop" button again deleted the message and the program starts:</p> <ul style="list-style-type: none"> <li>• You can continue operations simply by pressing the "Start / Stop" button twice when you start a program.</li> <li>• Select "Immed. print-out? Yes" (see Section 6.3.1.3)</li> <li>• Delete stored records (See Section 6.3.6), if necessary print-out all stored cycle records first (see Section 6.3.4)</li> </ul> <p>In the Data transfer menu, select the "No printer" option (see Section 6.3.1.3)</p>
<p style="text-align: center;"><b>Please service</b></p>	<p>The service message is activated after a certain number of loads or a set operating period, when a service is due. The message appears before the start of every program. If you press the "Start / Stop" button again the message is deleted and the program starts.</p> <ul style="list-style-type: none"> <li>• You can continue operations, by simply pressing the "Start / Stop" button twice when you start a program.</li> <li>• Have a service carried out as recommended by an authorised MELAG servicing company or your specialist dealer.</li> </ul> <p>The cycle counter for servicing should be reset during the service.</p>

Warning message	Cause / Remedy
<b>Test unsuccessful</b> <b>Leak rate: 3.8</b>	The leak rate during the vacuum test exceeds the limit value: <ul style="list-style-type: none"> <li>▪ Check and if necessary clean the door seal and the rim of the chamber</li> <li>▪ Repeat the vacuum test with a completely cold autoclave</li> </ul> If no other error reports occur during operation, you can continue to use the autoclave until the regular service, when the cause of the leak will be identified.

## 7.4 Error reports

Errors are generally reported by an "Error" on the display with the number of the error and its short name. Error reports may occur without a program start (when the power is switched on or soon after), or during a program.

If errors are reported during a program, then in addition to the error report the program will also be stopped. This may be accompanied by the equalisation of the pressure in the autoclave, and in this case the error message will alternate with the messages "Pressure release", or "Ventilation", and "End".

After the termination, the display will alternately show the error message and "Quit with "-" button" and then "Terminate End ". Pressing "-" deleted the error message (if the error is not permanent). Until you have quit the error message the autoclave door cannot be opened. If a program has been prematurely terminated in this way the autoclave load must always be regarded as being **not sterilized**. We recommend that you unload the autoclave, carry out a sterilization cycle without any load (the drying may be impaired for this first cycle) and then reload the autoclave and repeat the interrupted operation cycle.

If an external printer is connected and "Immed. print-out? Yes" is selected, a record will automatically be printed out at the end of the termination.

The print-out shows the full name of the error, and if a program has been interrupted before completion it will also show "Load not sterile". The following list gives error reports, the cause and possible remedies.

Error report	Cause / remedy
<b>Malfunction 1:</b> <b>Vacuum system</b>	The monitoring time for reaching the evacuation pressure for the individual pressure cycles, pressure release, or for reaching the minimum drying pressure has been exceeded: <ul style="list-style-type: none"> <li>▪ Check that the door seal and the lip of the opening to the pressure chamber are intact and clean.</li> <li>▪ Check that the autoclave is standing properly (see Section 2.3).</li> <li>▪ Check that the outflow of condensate is not obstructed by fallen instruments, pieces of filter paper, etc. on the floor of the pressure chamber.</li> <li>• Check that the flow filter is not blocked (at the front of the base of pressure chamber)  </li> <li>▪ Check for leaks using the "Vacuum test" program.</li> </ul> If this occurs repeatedly, inform your specialist dealer.
<b>Malfunction 2:</b> <b>Steam generator</b>	The monitoring time for the heating phase or for reaching the sterilization pressure has been exceeded: <ul style="list-style-type: none"> <li>▪ maximum load exceeded</li> <li>▪ voltage of mains power supply is too low; check mains supply; try autoclave on different power circuit.</li> </ul> If this occurs repeatedly, inform your specialist dealer.
<b>Malfunction 4:</b> <b>Pressure release</b>	The monitoring time for the ventilation of the pressure chamber was exceeded.: <ul style="list-style-type: none"> <li>• Check that the pressure releases at the rear of the chamber are not blocked</li> <li>• If this occurs repeatedly, inform your specialist dealer.</li> </ul>
<b>Malfunction 8:</b> <b>Timebase</b>	Maximum difference between the program duration and the internal clock exceeded: If this occurs repeatedly, inform your specialist dealer.

Error report	Cause / remedy
<p style="text-align: center;"><b>Malfunction 9: Door open</b></p>	<p>Door not closed properly</p> <ul style="list-style-type: none"> <li>▪ Press grip down until contact is made (display should then show "Door closed")!</li> <li>▪ If this occurs repeatedly, inform your specialist dealer.</li> </ul>
<p style="text-align: center;"><b>Malfunction 10: Steamgen. too hot</b></p>	<p>The capillary tube level regulator is open at the start of the program (error report immediately after start), or the monitoring time until refilling with demineralised or distilled water during the program (until the end of sterilization) is exceeded:</p> <ul style="list-style-type: none"> <li>• This problem can arise because after stopping a program and immediately restarting - wait for two minutes and try starting again.</li> </ul> <p>If this occurs repeatedly, inform your specialist dealer.</p>
<p style="text-align: center;"><b>Malfunction 12 Door lock</b></p>	<p>Maximum permissible time for door locking: Check the locking bolt can move freely</p> <ul style="list-style-type: none"> <li>▪ If this occurs repeatedly, inform your specialist dealer.</li> </ul>
<p style="text-align: center;"><b>Malfunction 14: Water supply</b></p>	<p>The flow monitor for the demineralized / distilled water supply does not close during the program (see message "Warning no feed water" - page 34).</p>
<p style="text-align: center;"><b>Malfunction 18: Sens defect Nr.</b></p>	<p>The internal testing of the sensors for temperature, pressure or conductivity showed an excessive deviation, the error can be reported on switching on the appliance or in the course of a program:</p> <ul style="list-style-type: none"> <li>▪ If this occurs repeatedly, inform your specialist dealer.</li> </ul>
<p style="text-align: center;"><b>Malfunction 21: Preheating</b></p>	<p>The pre-heating has not reached the necessary temperature within the specified time limit: If this occurs repeatedly select the option "Automatic preheating No" and inform your specialist dealer (see Section 6.5).</p>
<p style="text-align: center;"><b>Malfunction 22: Overheating</b></p>	<p>The maximum preheating temperature was exceeded:</p> <ul style="list-style-type: none"> <li>▪ If this occurs repeatedly start the autoclave without preheating and inform your specialist dealer.</li> </ul>
<p style="text-align: center;"><b>Malfunction 23: Current</b></p>	<p>The monitoring time for the pressure release in the outflow process for the fractionation was exceeded:</p> <ul style="list-style-type: none"> <li>• Check that the flow filter at the bottom of the chamber close to the door is not blocked</li> <li>▪ If this occurs repeatedly, inform your specialist dealer.</li> </ul>
<p style="text-align: center;"><b>Malfunction 26: A/D-Converting</b></p>	<p>The limit deviation for internal analog/digital signal conversion has been exceeded:</p> <ul style="list-style-type: none"> <li>▪ If this occurs repeatedly, inform your specialist dealer.</li> </ul>
<p style="text-align: center;"><b>Malfunction 27: Temp. sens. def 1,2</b></p>	<p>The limit deviation between the two sensors for the steam temperature has been exceeded: If this occurs repeatedly, inform your specialist dealer.</p>
<p style="text-align: center;"><b>Malfunction 29: Battery RAM</b></p>	<p>There is a data inconsistency or a data loss in the processing unit memory. This can be the result of a major disturbance to the mains electricity supply or an insufficient battery voltage. On quitting, the clock will automatically reset to 00.00 and the load count will reset to the value from the EEPROM. At the same time all records in the memory will be deleted:</p> <ul style="list-style-type: none"> <li>▪ After quitting the error report: Reset time and date (see Section 6.4) and restart.</li> <li>▪ If this occurs repeatedly, inform your specialist dealer.</li> </ul>

Error report	Cause / remedy
<p style="text-align: center;"><b>Malfunction 31: System leak</b></p>	<p>During the Vacuum test program the pressure was too high (very large leak): Repeat the vacuum test, and if there is another error report inform your specialist dealer</p>
<p style="text-align: center;"><b>Malfunction 32: Power failure</b></p> <p style="text-align: center;"><b>Sterile filter sterilize</b></p>	<p>After starting the program there was a loss of power. The error report is received when the electricity supply is restored:</p> <ul style="list-style-type: none"> <li>▪ Check the mains power supply installation, if no errors can be found, inform the service agent.</li> </ul> <p>If there is a loss of power when the chamber is under pressure, then there will be an additional reminder to sterilize the sterile filter, since this may have become moist and non-sterile:</p> <ul style="list-style-type: none"> <li>▪ Remove the sterile filter at the rear of the autoclave.</li> <li>▪ Sterilize the filter using the rapid program.</li> <li>▪ Then replace the filter.</li> </ul>
<p style="text-align: center;"><b>Malfunction 33: Pressure drop</b></p>	<p>The time limit for the steam generator to reach the necessary pressure has been exceeded:</p> <ul style="list-style-type: none"> <li>• If this occurs repeatedly, inform your specialist dealer.</li> </ul>
<p style="text-align: center;"><b>Malfunction 34: Sterilization TU</b></p>	<p>The minimum sterilization temperature has not been reached:</p> <ul style="list-style-type: none"> <li>▪ Reduce the size of the load.</li> <li>▪ If this occurs repeatedly, inform your specialist dealer.</li> </ul>
<p style="text-align: center;"><b>Malfunction 35: Sterilization TO</b></p>	<p>The maximum sterilization temperature has been exceeded:</p> <ul style="list-style-type: none"> <li>▪ If this occurs repeatedly, inform your specialist dealer</li> </ul>
<p style="text-align: center;"><b>Malfunction 36: Sterilization PU</b></p>	<p>Sterilization pressure falls below the minimum level:</p> <ul style="list-style-type: none"> <li>▪ Reduce the size of the load.</li> <li>▪ If this occurs repeatedly, inform your specialist dealer</li> </ul>
<p style="text-align: center;"><b>Malfunction 37: Sterilization PO</b></p>	<p>The maximum sterilization pressure has been exceeded:</p> <ul style="list-style-type: none"> <li>▪ If this occurs repeatedly, inform your specialist dealer.</li> </ul>
<p style="text-align: center;"><b>Malfunction 38: Sterilization TD</b></p>	<p>The difference between measured and theoretical temperature is too large:</p> <ul style="list-style-type: none"> <li>• If this occurs repeatedly, inform your specialist dealer.</li> </ul>
<p style="text-align: center;"><b>Malfunction 41: Current drying</b></p>	<p>The monitoring period for the pressure release in the flow release during drying was exceeded:</p> <ul style="list-style-type: none"> <li>• Check that the flow filter at the bottom of the chamber close to the door is not blocked</li> <li>▪ If this occurs repeatedly, inform your specialist dealer.</li> </ul>
<p style="text-align: center;"><b>Malfunction 42: Drying press.-pump</b></p>	<p>The monitoring time for the pressure increase during pressure drying was exceeded:</p> <ul style="list-style-type: none"> <li>• Check that the sterile filter is not blocked, if necessary replace</li> <li>▪ If this occurs repeatedly, inform your specialist dealer.</li> </ul>
<p style="text-align: center;"><b>Malfunction 43: Drying Vac.-pump</b></p>	<p>The monitoring time for vacuum generation during vacuum drying was exceeded:</p> <ul style="list-style-type: none"> <li>• Check that the flow filter in the chamber directly behind the door is not blocked</li> <li>▪ If this occurs repeatedly, inform your specialist dealer.</li> </ul>



## 8 Taking care of your autoclave

---

### 8.1 Preparation of instruments

---

#### **MELAG - rust-free materials**

All parts of the Euroklav®29V-S which come into contact with steam are made on non-rusting materials: the pressure chamber and the door of stainless steel, steam pipes of Teflon, and screws and magnet-valves of bronze.

#### **Film rust**

The use of these materials means that no parts of the autoclave can initiate rust formation. Where rust does attack the autoclave or instruments sterilized in it, tests repeatedly show that this has been brought into the autoclave on instruments (film rust).

Even top-quality stainless steel instruments can form rust if they are not handled properly, e.g. if they are treated with the wrong chemical cleaning or disinfecting agents.

#### **Preparing items for sterilization**

The example of the formation of film rust shows how important it is to prepare items properly before sterilization.

Handpieces and contra-angles must be cleaned before sterilization and maintained (e.g. by oiling). Other instruments must be disinfected and cleaned immediately after use in accordance with UVV/VBG 103, or similarly strict national codes of practice in a disinfectant and/or cleaning solution at the correct concentration for the correct length of time

MELAG recommends the use of cleaning aids such as ultrasonic baths, cleaning and maintenance equipment for handpieces for contra-angles, as well as thermo-disinfecting devices.

It is essential that the instruments are well cleaned in order to avoid dirt and contamination being separated from the load in the autoclave and clogging filters, valves, and nozzles. In particular locks, joints, and hinges must be cleaned thoroughly with a brush before sterilization. No traces of cleaning and disinfecting agents should be allowed to enter into the sterilization chamber of the autoclave, since this can give rise to corrosion! The instruments should be swilled off with demineralized water and then dried off before being loaded in the autoclave. Turbines and handpieces must be oiled in accordance with the manufacturer's instructions in order to ensure their long working life.

#### **Brand-new instruments**

The cleaning procedures described above must also be followed before sterilizing brand-new instruments. These often carry small amounts of grease, oil and soiling from the manufacturing process.

**Important:** Carefully follow all instructions provided by manufacturers of instruments for the preparation of their products for first-time sterilization and for subsequent sterilizations.

### 8.2 Rust formation = Drag-in rust

---

As already explained, the non-rusting materials used in the autoclave cannot cause rust formation in the autoclave!

Where rust forms this is "drag-in rust". This originates from instruments or other metal items carrying traces of rust, even though they are made of stainless steel, or which are made of normal steel but which have a damaged galvanic coating. Often, a single rusty instrument is enough to pass rust on to other instruments or to lead to film rust forming in the autoclave resulting to corrosion damage. Drag-in rust must be removed from the affected instruments or from the autoclave and tray assembly using a mild commercial cleaning agent for stainless steel. (This should not contain of chlorine).. Do not use steel wool, a wire brush or other abrasive cleaners! Spots can be removed with a damp, lint-free cloth or a cloth with surgical spirits or alcohol.

## 8.3 Taking care of the Euroklav® 29V-S

### 8.3.1 Cleaning

The tray assembly and the autoclave chamber including the contact area of the door gasket and the door opening should be inspected thoroughly at least once a week for signs of damage or soiling. If necessary, wipe out the autoclave chamber using a **lint-free cloth** and surgical spirits. This involves withdrawing the trays and tray guide assembly. Stubborn spots can be removed using small amounts of a mild commercial steel cleaning agent (pH-levels from 5 to 8). Care must be taken to ensure that cleaning agent does not get into the pipes attached to the autoclave chamber. The cleaning agent must not contain chlorine and should not be alkaline. Do not use abrasive cleaning pads, steel wool, or brushes.

Inspect the door seal every week for signs of damage and soiling, and if necessary clean it with a mild commercial liquid cleaning agent (pH-levels from 5 to 8) or with surgical spirits. If necessary, the seal can be removed.

The bolt of the door lock (right side) and the door hinge (left side) must be regularly lubricated with silicone grease (MELAG Art.No. 24355), in order to ensure that the door can easily be locked and unlocked, without unnecessary wear.

The outer parts of the autoclave can be cleaned with a mild commercial cleaning agent or with surgical spirits. If water is supplied from and returned to the internal tank, then this should be inspected before refilling with distilled / demineralized water. Whenever necessary it should be cleaned. The wastewater tank on the left should be emptied at least every two weeks and washed out with clear mains-supply water. Hard stains and oily residues may have to be removed using a little washing-up liquid and warm mains-supply water with a suitable soft brush, followed by swilling with distilled / demineralized water. Should the right tank need cleaning after a lengthy period of close-loop operation then this should be cleaned in the same way, and also thoroughly swilled.

### 8.3.2 Use of demineralized or distilled water

#### Quality requirements

For steam sterilization it is necessary to use high quality distilled or demineralized water.

The water used should at least comply with the specifications in accordance with CEN-standard EN 285 listed in the table below.

For the operation of the Euroklav® 29V-S, however, **battery water in accordance with VDE 510** is sufficient, as long as the VDE specifications are strictly adhered to (conductivity on production  $\leq 10 \mu\text{S}/\text{cm}^*$ , when used  $\leq 30 \mu\text{S}/\text{cm}^*$ , pH-value identical with EN 285, evaporation residues analogous).

#### Where to purchase the water

Battery water in accordance VDE 510 is widely available in large drug stores, supermarkets and do-it-yourself stores at low prices. The necessary purity standards must be expressly detailed on the label, because with insufficiently pure water calcium scaling could form in the steam lines and valves, restricting the operation of the autoclave. Aggressive water (pH < 5 or > 7) can also lead to damage in the autoclave.

#### Formation of spots on instruments

The extent to which spots form on the instruments depends on the quality of the water used to produce the steam.

#### Specifications for water quality in accordance with the EN 285

Evaporation residue	$\leq 10 \text{ mg/l}$
Silicon oxide, $\text{SiO}_2$	$\leq 1 \text{ mg/l}$
Iron	$\leq 0.2 \text{ mg/l}$
Cadmium	$\leq 0.005 \text{ mg/l}$
Lead	$\leq 0.05 \text{ mg/l}$
Other heavy metals	$\leq 0.1 \text{ mg/l}$
Chlorides (Cl)	$\leq 2 \text{ mg/l}$
Phosphates ( $\text{P}_2\text{O}_5$ )	$\leq 0.5 \text{ mg/l}$
Conductivity at 20°C	$\leq 15 \mu\text{S}/\text{cm}^*$
pH (degree of acidity)	5 - 7
Appearance	Colourless; clean; without sediment
Hardness ( $\Sigma$ of ions of alkaline earth)	$\leq 0.02 \text{ mmol/l}$
<b>Note:</b> The use of feed water or steam with contaminants at levels exceeding those given in table can greatly shorten the working life of a sterilizer and can invalidate the manufacturer's warranty or guarantee.	

\*)  $\mu\text{S}/\text{cm}$  = micro-Siemens per centimetre

## 8.4 Checking the operation of the autoclave \_\_\_\_\_

### 8.4.1 Safety with automatic monitoring \_\_\_\_\_

The electronic parameter control means that all relevant parameters are constantly monitored and compared with standard process data, so that error reports can be made immediately. If a program is completed without problems then on its completion there is an "End" message. The print-out contains a corresponding report.

The operator of the autoclave can check the progress of the program at any time by means of the values shown on the display (or after its completion by means of the print-out).

### 8.4.2 Periodical bacteriological testing (twice a year) \_\_\_\_\_

The German industrial standard DIN 58 946 Part 8 Section 3.2 recommends:

"Periodical testing shall be carried out at the place of installation, e.g. at 6 monthly intervals. They shall demonstrate that sterilization is carried out satisfactorily when the operating instruction for the small sterilizer are followed."

Hygiene institutes and regional medical test centres can supply test spores on request and document the results of sterilization on a test form.

### 8.4.3 Maintenance recommendations \_\_\_\_\_

Regular maintenance of the autoclave is important if it is to have a long life and remain in good working order.

MELAG recommends that the Euroklav®29V-S be serviced annually by a trained technician in accordance with maintenance instructions for this autoclave. The annual service includes a visual inspection and a test of operational functions. As well as all essential components and electrical elements, parts are also inspected for wear and replaced as necessary.

A maintenance reminder appears on the display every two years or after 1000 sterilizations.

Consult your dealer or the MELAG Customer Service if you have any questions relating to servicing and maintenance.

## 9 Annex

### 9.1 Installation options

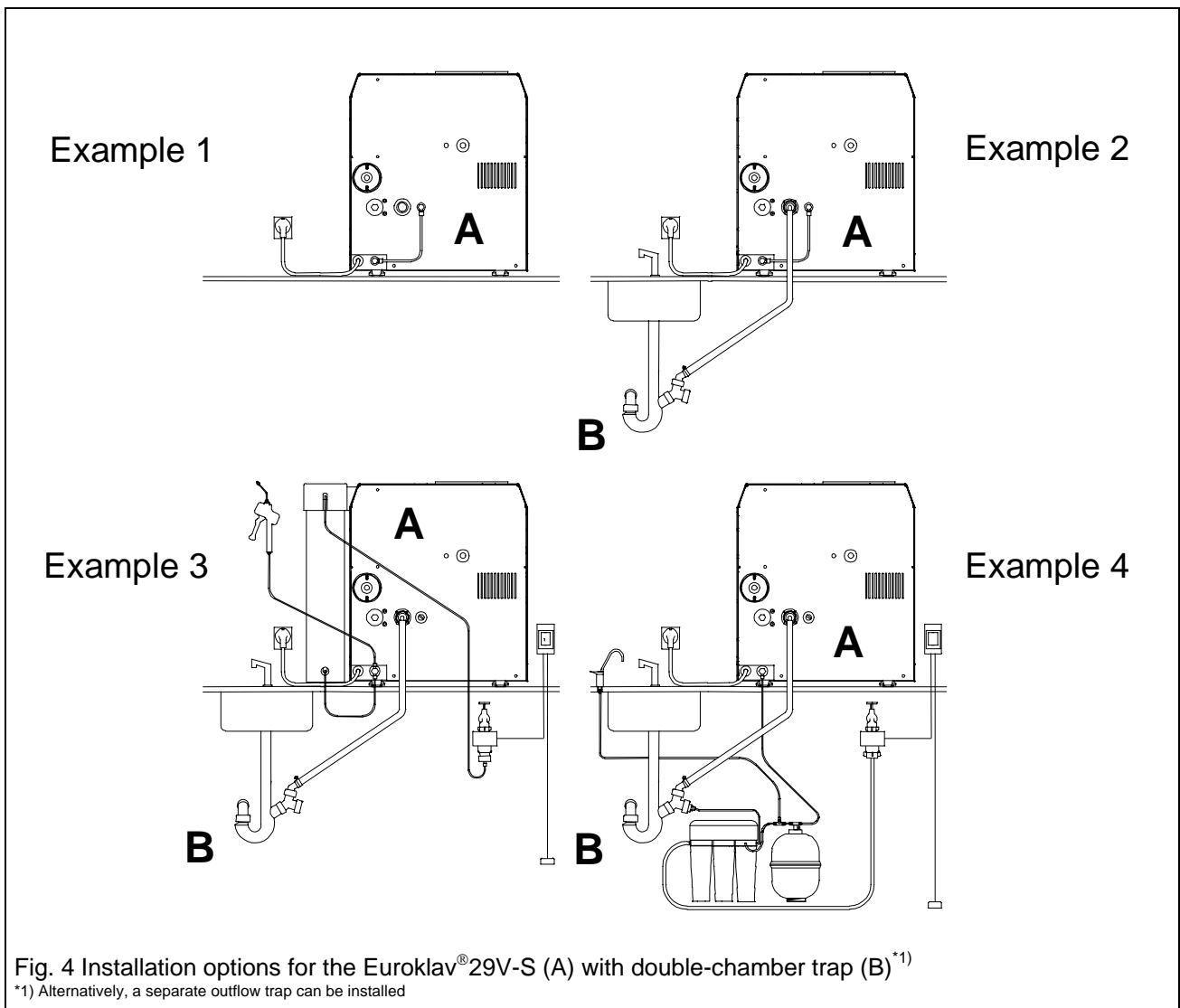

#### Example 1

Euroklav<sup>®</sup> 29V-S (rear view), basic version  
Water supply by means of internal double chamber storage tank

#### Example 2

Euroklav<sup>®</sup> 29V-S (rear view) with one-way water outflow installed  
Double chamber trap

#### Example 3

Euroklav<sup>®</sup> 29V-S (rear view) with installed MELAdem<sup>®</sup> 37 and MELAjet<sup>®</sup>  
Double chamber trap  
Leak detector with stop valve (optional)  
MELAdem<sup>®</sup> 37  
MELAjet<sup>®</sup> (optional)

#### Example 4

Euroklav<sup>®</sup> 29V-S (rear view) with installed MELAdem<sup>®</sup> 47  
Double chamber trap  
Leak detector with stop valve (optional)  
MELAdem<sup>®</sup> 47

## 9.2 Additional technical data

### 9.2.1 Capacity / Weight

<b>Weight (unloaded)</b>	40 kg
<b>Chamber volume</b>	17,6 litre
<b>Maximum load</b>	3 kg instruments or 0.9 kg textiles
<b>Loading options:</b>	Set-up "A" with max. 6 MELAG-trays Set-up "B" with max. 4 standard tray-cassettes or 4 MELAG-trays  MELAG- Sterilization containers: 28M,28G,23R, (15 K,M,G,17 K) Foil holder

### 9.2.2 External supplies

<b>Electric power supply</b>	
Mains supply	230 V AC, 10.4 A, 50...60 Hz
Rating	2400 W; 16 A fuses, residual current circuit breaker 30 mA
<b>Distilled / demineralized water</b>	Distilled or demineralized water in accordance VDE 0510

### 9.2.3 Operational parameters

#### 9.2.3.1 Programs / Operation times

Program	Operation time (without drying):		Drying time:
	Warm start/ low load	Warm/ max. load	
"Quick program unwrapped" (134°C, 2bar)	12.5 min	15 min	12-15 min
"Universal program" (134°C, 2bar)	20 min	22 min	22-26 min
"Gentle program" (121°C, 1bar)	32 min	35 min	27-30 min

#### 9.2.3.2 Energy / Water consumption

"Pre-heating"	
Warming up to pre-heating temperature (134°C)	ca. 0.12 kWh (= 3 pf <sup>1)</sup> )
"Stand by" mode/ hour	ca. 0,2 kWh (= 5 pf)
Program + drying	0.3 kWh (= 7.5 pf) for "Quick Program", warm start, low load, up to a maximum of 1.1 kWh (= 27.5 pf) for "Gentle program", cold start, full load
<b>Consumption of distilled / demineralized water</b>	400 ml (= 8 pf <sup>2)</sup> ) for "Unwrapped instruments", 550 ml (= 11 pf) for "Wrapped instruments" 650 ml (= 13 pf) for "Textiles"

1) Based on a price of DM 0.25 / kilowatt-hour

2) Based on a price of DM 0.20 per litre distilled water from the MELAdest 65

## 9.3 Instructions on drying

The Euroklav<sup>®</sup>29V-S provides very good drying standards for sterilized items. Particularly difficult drying tasks (e.g. double wrapping) can also be dried to very good standards with the help of the supplementary drying function and the automatic pre-heating (see Sections 6.2, 6.5). Please read the following sections, which may help you to optimise your drying results.

### 9.3.1 Drying in sterilization containers

In the autoclave steam is produced by heating water. The steam transfers heat to the instruments and sterilization container and warms these. This leads to steam condensing on the instruments and containers.

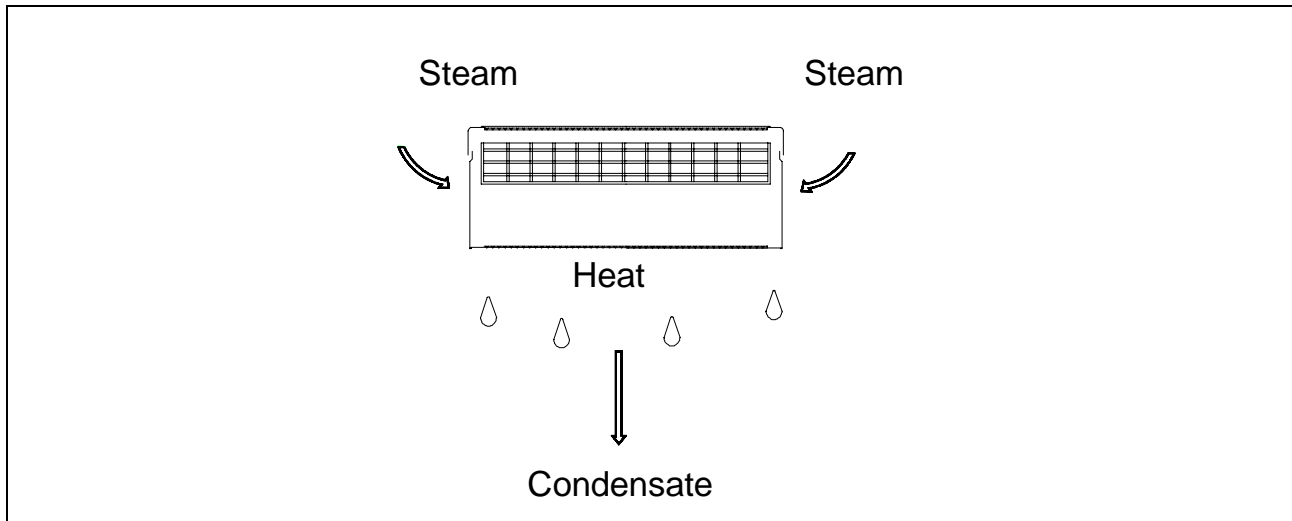

Formation of condensation on the sterilization container

The steam also heats the objects contained in the sterilization containers. Condensation forms on the objects being sterilized, and some of the condensation drops to the bottom of the sterilization container.

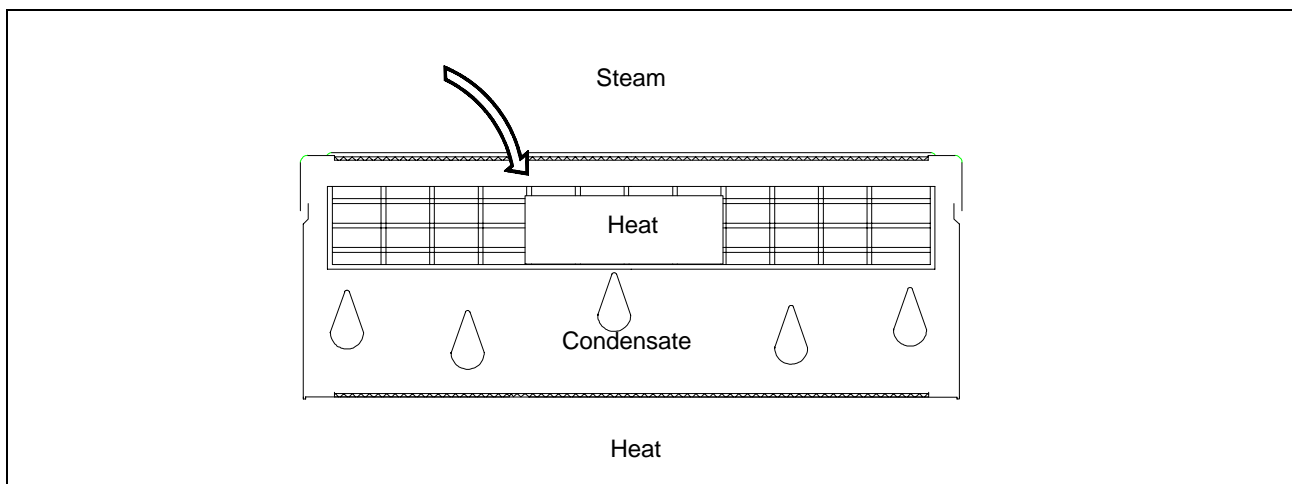

Formation of condensation on sterilized objects

After sterilization, during the drying phase, all the condensation must evaporate from the sterilization container and from the sterilized items themselves. This is achieved by the transfer to the condensate of heat stored in the walls of the sterilization container and in the sterilized items themselves. It is preferable that the sterilization container be made of aluminium, as this metal stores and conducts heat well, ensuring faster drying than other materials.

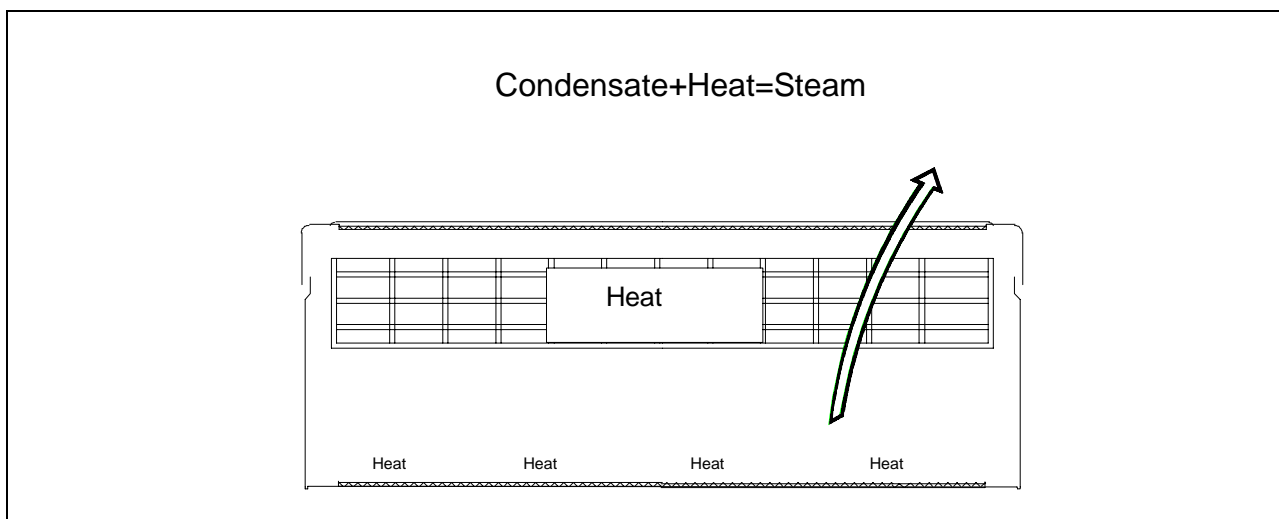

### Drying

For good drying it is essential that surplus heat be transferred to the objects which have been sterilized. In addition, the condensation must be led out of the sterilization containers. The floor of the containers have channels and the lid has an arched filter area.

### 9.3.2 Textiles

When preparing textiles for treatment in the autoclave, care must be taken that the folds in the textiles are arranged in parallel, and that the items are packed side-by-side. This vertical configuration ensures that channels can form between the textile folds for the air to flow out and steam to flow in. Do not stack textiles on top of each other as this hinders the penetration of steam into the packages of textiles.

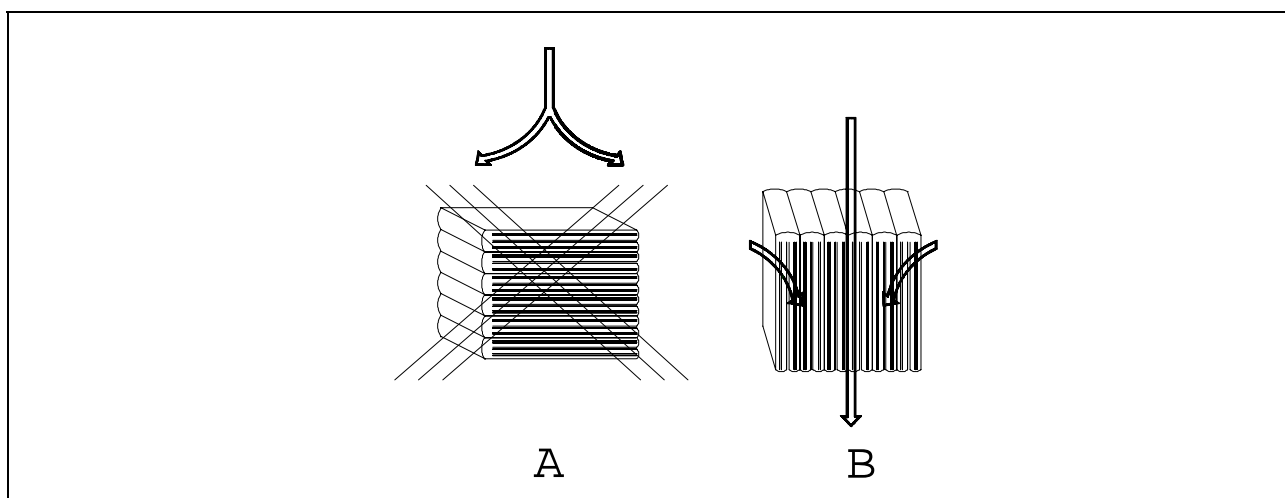

### Loading textiles properly

When loading sterilization containers with textile items, care should be taken to ensure that they retain their vertical orientation, but that the items are not squashed together. This would prevent the formation of flow channels for air and steam. If the packages of textiles cannot be kept upright, then it might be advisable to wrap them in sterilization paper.

The textiles must not touch the sides or the base of the sterilization container, since they might become saturated with condensate.

For good drying results, the textiles should also be as dry as possible when they are placed in the autoclave. The heat stored in the chamber and sterilization container may not otherwise be sufficient to evaporate both the moisture and the condensation.

### 9.3.3 Instruments

Where appropriate, instruments should be disassembled before placing them in the autoclave, as this will improve the drying results.

The use of lubricants (such as instrument oil) should be avoided unless absolutely necessary. Prior confirmation should be obtained from the manufacturer of such agents that they are in fact suitable for steam sterilization. Substances which are hydrophobic or impenetrable for steam can not only lead to poor drying results, but may also mean that the steam sterilization is unsuccessful, since not only the instruments are protected but also micro-organisms..

### 9.3.4 Loading the autoclave

Textiles and instruments should not be sterilized together in one sterilization container. Textiles and instruments in separate sterilization containers should as far as possible not be sterilized in the same load. However, where this is unavoidable for economic or other reasons, the following rules should be observed:

- Instruments and sterilization containers should be placed at the bottom
- Textiles should always be placed at the top
- Transparent sterilization packages and paper sterilization packages should be placed at the top (except when in combination with textiles, in which case they must be at the bottom).

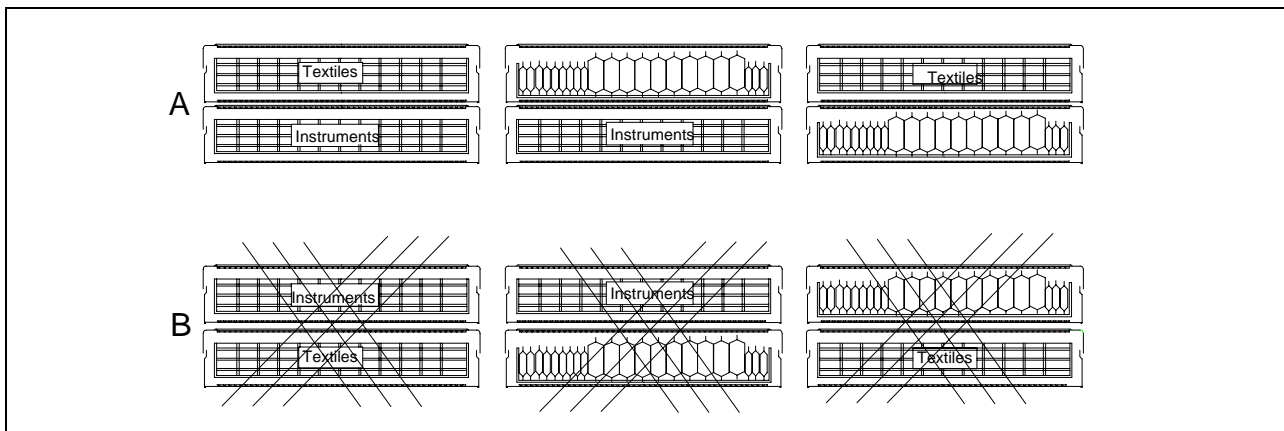

Loading the autoclave

### 9.3.5 Loading containers with soft sterilization packing material

"Soft" sterilization packages such as paper bags or transparent sterilization packages can be sterilized either in sterilization containers or sterilization baskets. To enable better drying, arrange such soft sterilization packages side-by-side and close to each other. This allows condensation to run off the packages, while at the same time preventing them from expanded excessively, and possibly bursting at the seams.

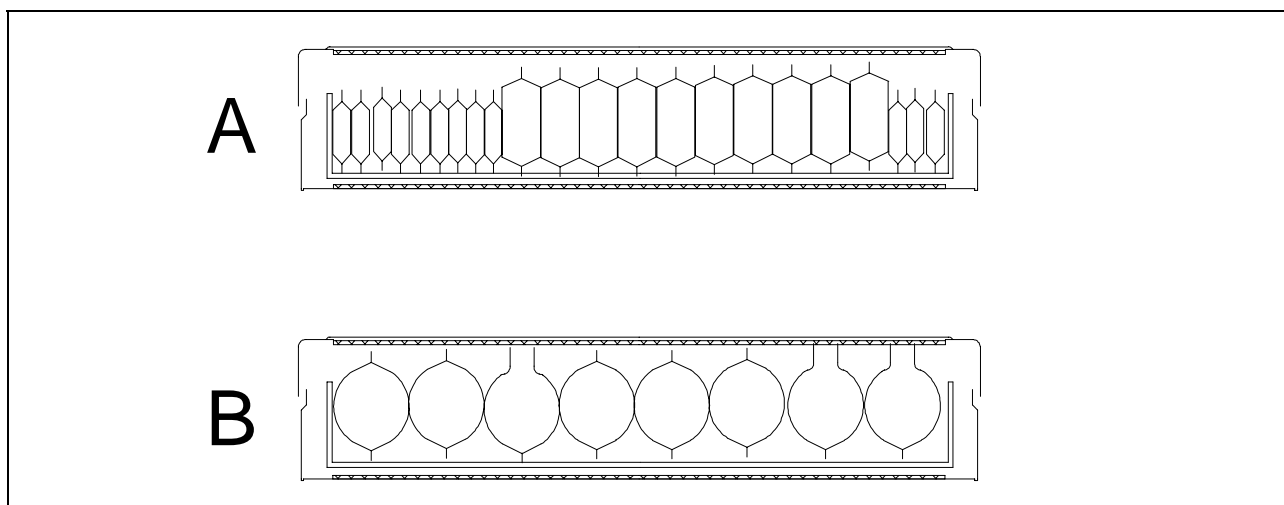

Packing "soft" sterilization packages in sterilization containers



## 9.3.6 Stacking sterilization containers

When arranging sterilization containers, care should be taken that drops of condensate do not wet items being sterilized beneath, but can flow away to the base of the chamber. The best arrangement is a stack of sterilization containers of the same size, so that condensate can flow down the sides.

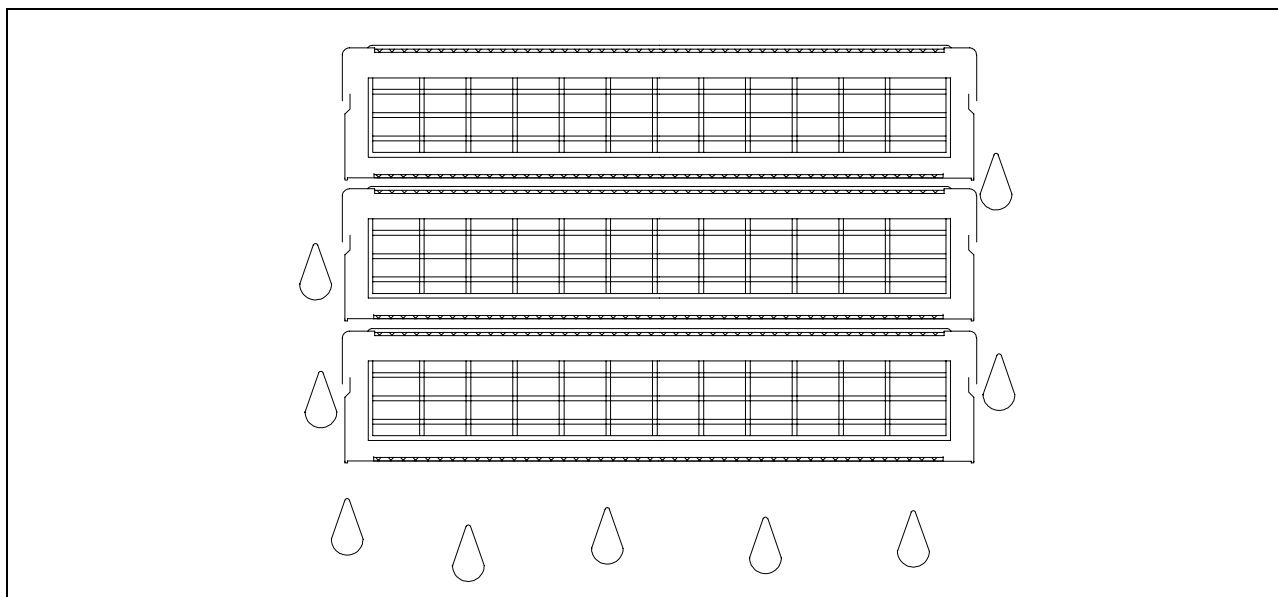

Stacked sterilization containers

## 9.3.7 Removing the sterilized items

Immediately after the sterilization process, some condensate may remain on the sterilized items. However, heat transfer from the sterilized objects can evaporate this after the sterilization process has been completed.

The German standard DIN 58953 Part 7 Section 7 comments on residual moisture on paper bags or transparent sterilization paper after sterilization:

"...Small amounts of water on the surface of packages do not represent a cause for concern if they dry completely within thirty minutes after removal from a steam sterilization system...."

## 9.3.8 Improving the drying

The drying can be improved by the following measures:

- Pre-heating the autoclave (empty sterilization)
- Arranging transparent sterilization and paper packing vertically
- Selecting the program option "Additional drying"
- Extending the drying times (please consult your MELAG customer service).